



SLIMLINE ELECTROL®

Automatic Electric Projection Screen

SPECIFICATION DATA

DA-LITE SCREEN COMPANY, INC.
 3100 North Detroit Street
 Post Office Box 137
 Warsaw, Indiana 46581-0137
 Phone: 574/267-8101
 800-622-3737
 Fax: 574/267-7804
 http:// www.da-lite.com
 e-mail: info@da-lite.com

SUGGESTED SPECIFICATIONS: _____ projection screens, _____ (H) x _____ (W), electrically operated 120 volt (60 HZ) 1.2 amp. Shall have specially designed motor mounted inside the roller to be three wire with ground quick reversal type, oiled for life, with automatic thermal overload cut-out, integral gears, capacitor and an electric brake to prevent coasting. To have preset but adjustable limit switches to automatically stop picture surface in the "up" and "down" positions. The roller to be of rigid aluminum, 1-1/2" in diameter. Screen fabric to be flame retardant and mildew resistant fiberglass with High Power picture surface. (With black masking borders.) Bottom of fabric shall be mounted into a metal strip in a tubular steel slat finished in baked enamel. Ends of the slat shall be protected by plastic outer caps. Case to be 22 gauge embossed steel, 2-3/4" in width, octagon in shape with flat back design finished in baked enamel. Case with sturdy brackets for wall or ceiling installation. To be complete with 3 ft. control cable to operating switch built into line and 6 ft. power cable (2 wire plus ground) from switch to 3-prong plug. Screen to be listed by Underwriters' Laboratories and CSA.



DIMENSIONS

Sizes		A - Overall Case Length		B - Between Hanger Eyes		Approx. Ship. Wt.	
H x W	Cm	In.	Cm	In.	Cm	Lbs.	Kg
60" x 60"	152 x 152	68-7/8"	175	68-1/8"	173	22	9.98
70" x 70"	178 x 178	78-7/8"	200	78-1/8"	198	24	10.89

VIDEO FORMAT SIZES

Viewing Area Sizes		Nominal Diagonal		A - Overall Case Length		B - Between Hanger Eyes		Approx. Ship. Wt.	
H x W	Cm	In.	Cm	In.	Cm	In.	Cm	Lbs.	Kg
43" x 57"	109 x 145	72"	183	68-7/8"	175	68-1/8"	173	22	9.98
50" x 67"	127 x 170	84"	213	78-7/8"	200	78-1/8"	198	24	10.89
60" x 80"	152 x 203	100"	254	92-7/8"	236	92-1/8"	234	26	11.79

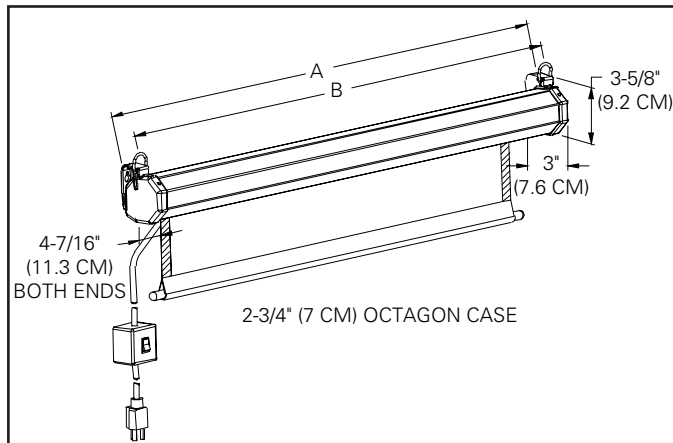

SUGGESTED METHODS OF INSTALLATION

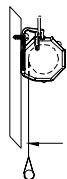

WALL MOUNTING
 Slip hanger eyes over screws well secured in wall.

PICTURE SURFACE

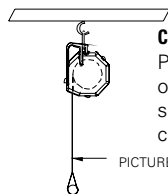

CEILING MOUNTING
 Place "D" Rings over hooks well secured in ceiling.

PICTURE SURFACE

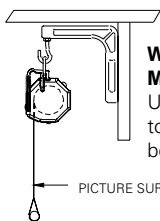

WALL BRACKET MOUNTING
 Use No. 6 brackets to hang behind beam or valance.

PICTURE SURFACE

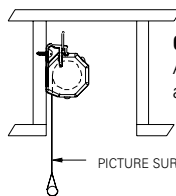

CONCEALED
 Allow room for access.

PICTURE SURFACE

HANGING BRACKETS

(Optional at extra cost)

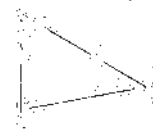

NO. 11 WALL BRACKET
 Non-adjustable permits screen to extend 10" or 14" from wall.

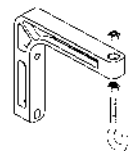

NO. 6 WALL BRACKET
 Non-adjustable permits screen to extend 6" from wall.

PLEASE MARK APPROPRIATE SELECTIONS:

Select size from chart above

Select viewing surface:

High Power

Options:

- No. 6 Non-adjustable Extension Brackets
- No. 11 Non-adjustable Extension Brackets
- 220V (50 HZ Motor)
- No Borders (Black Masking Borders standard)

Specifications are subject to change without notice.

Project: _____

Architect: _____

Phone: _____

Contractor: _____

Phone: _____

Supervisor: _____

Phone: _____

Date: _____

Revised: _____