

CineTension2 Series

- Tab-Tensioned Electric Screen
- Premium Grade Tension Electric Screen

FEATURES & BENEFITS

Screen Material:

- CineWhite 1.1 Gain Screen Tension Material is flat, durable and easy to clean screen material.
- AcousticPro1080 1.0 Gain Screen material for acoustically transparent applications.
- 160 degree wide-viewing angle for commercial and residential presentations
- Black backed screen material eliminates light penetration for superior color reproduction
- Black masking enhances picture contrast

Housing Finish and Installation

- Heavy Duty Aluminum Housing with enamel coating is moisture resistant.
- Floating Brackets are made for easy alignment in wall or ceiling installations.
- Ships fully assembled with 3-prong power connection ready to Plug & Play
- Side-Sliding motor design for easy access service & maintains

Tension & Motor System:

- Tab-tensioned cords provide uniform flatness on entire projection surface
- Tubular motor allows fast swift operation with a superior weight tolerance and operational lifespan

Control System:

- Infrared remote and wall switch
- Internal IR and Radio Frequency remotes and wall switch
- 5-12 volt trigger synchronizes with projector
- Adjustable vertical limit switch
- Optional In-wall up/down switch and wireless 5-12V controls available

Quality and Reliability

- Standard 2-year parts and labor warranty
- 3-year warranty for GEMR (Government, Education, Military and Religious) - US only
- ETL, FCC, CE, CB GOSTCE & ISO9001:2008 Certified



Standard IR & RF remotes and built-In Infrared & Radio Frequency Receivers support your Screens On-wall or In-Ceiling application for a clean appearance. A Low Voltage Controller (LVC) is included with 5-12V trigger port (RJ45) that can be connected to your projector Trigger port. This enables synchronization between the drop/rise cycle of your screen and the power cycle of the projector. You could extend this port using a standard RJ45 connector and CAT-5 cable to anywhere in the room. Or mount your Wall-switch like a regular light Switch.

Extra Eye IR Receiver can be extended when screen is recessed into ceiling and can still be controlled with your IR remote or Universal Learning Remote Control.

Optional Control Accessories:

- Wireless (RF) 5-12V Trigger (Model # ZSP-TR01)
- 50 feet CAT-5 cable for 5-12 volt trigger (Model # ZSP-12V-50B)
- In-wall Up/Down switch (Model ZIW-B, ZIW-W & ZIW-W1)





CineTension2 Series screens are available with up to 30" seamless top masking borders on select models.

This is ideal for recessed ceiling installations using our Optional In-Ceiling Trim kit. The vertical drop/rise position is pre-set for optimum visibility but is adjustable to suit your various needs.

Please contact our Tech-support for more information about this feature.

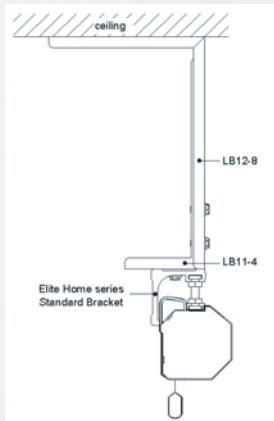

Standard Wall / Ceiling Sliding Brackets, make it easier to mount on Stud. Optional 11"x 4" and 12"x 8" L brackets can allow more flexibility when installing the screen away from walls. Please contact your reseller or visit shop.elitescreens.com for accessory parts.

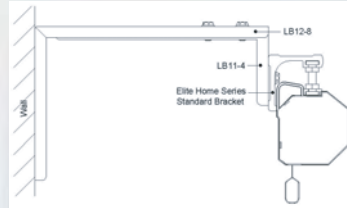

Optional Elite ZR800D Universal Learning Remote Control, allows one-touch regulation over your entertainment system managing up to 8 devices simultaneously. Each unit has a simplified programming option with learning function to accompany 800 pre-programmed TV/DVD/VCR codes.



ZHOME LB11-4



Standard Wall/Ceiling Brackets

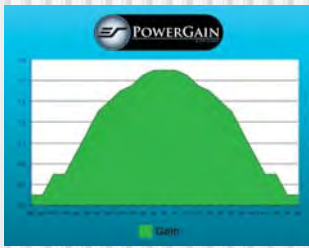

PowerGain Screen Material is a 1.8 gain pearlescent material capable of enhancing the color reproduction with low output projectors or countering the effects of ambient light. Its special surface coating it provides a

high uniformity while decreasing hot-spotting to virtually non-existent levels

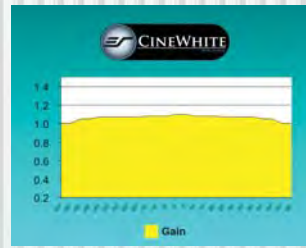

CineWhite Screen Material is our most popular by far with its universal applications. It has a 160° wide viewing Angle in 1.1 Gain, suitable for today's new high contrast ratio projectors in both home theater and commercial presentations

commercial presentations

CineTension2 Series: Premium Electric/Motorized Screen IR/RF/Wall Box/12V Trigger

Model	Nominal Diagonal	View Height (in)	View Width (in)	View Height (cm)	View Width (cm)	UPS or FedEx	Net Weight (lbs)	Gross Weight (lbs)	Net Weight (kgs)	Gross Weight (kgs)	Packaging Dimension (LxHxW)	Gain	Screen Material	Optional Ceiling Trim Kit
TE84VG2	84" (4:3)	50.4	67.2	128.0	170.7	Yes	27.6	39.4	12.5	17.9	89.1"x6.5"x8"	1.8	PowerGain	ZCTET84V
TE92VG2	92" (4:3)	55.0	73.3	139.7	186.2	Yes	29.1	42.0	13.2	19.0	94"x7.3"x8.5"	1.8	PowerGain	ZCTE92V
TE100VG2	100" (4:3)	60.0	80.0	152.4	203.2	Yes	43.0	59.5	19.5	27.0	103.5"x7.5"x9.75"	1.8	PowerGain	ZCTE100V
TE120VG2	120" (4:3)	72.0	96.0	182.9	243.8	No	47.8	65.5	21.7	29.7	120.7"x7.5"x9.75"	1.8	PowerGain	ZCTE120V
TE84VW2	84" (4:3)	50.4	67.2	128.0	170.7	Yes	27.6	39.4	12.5	17.9	89.1"x6.5"x8"	1.1	CineWhite	ZCTE84V
TE84VW2-E30	84" (4:3)	50.4	67.2	128.0	170.7	Yes	27.6	41.5	12.5	18.8	89.1"x6.5"x8"	1.1	CineWhite	ZCTET84V
TE92VW2	92" (4:3)	55.0	73.3	139.7	186.2	Yes	29.1	42.0	13.2	19.0	94"x7.3"x8.5"	1.1	CineWhite	ZCTE92V
TE100VW2	100" (4:3)	60.0	80.0	152.4	203.2	Yes	43.0	59.5	19.5	27.0	103.5"x7.5"x9.75"	1.1	CineWhite	ZCTE100V
TE100VW2-E12	100" (4:3)	60.0	80.0	152.4	203.2	Yes	43.0	59.5	19.5	27.0	103.5"x7.5"x9.75"	1.1	CineWhite	ZCTE100V
TE120VW2	120" (4:3)	72.0	96.0	182.9	243.8	No	47.8	65.5	21.7	29.7	120.7"x7.5"x9.75"	1.1	CineWhite	ZCTE120V
TE135VW2	135" (4:3)	81.0	108.0	205.7	274.3	No	51.5	70.6	23.4	32.0	132.8"x7.5"x9.75"	1.1	CineWhite	ZCTE135V
TE150VW2*	150" (4:3)*	90.0	120.0	228.6	304.8	No	56.4	77.2	25.6	35.0	145.7"x7.5"x9.75"	1.1	CineWhite	ZCTE150V
TE84HC2	84" (16:9)	41.2	73.2	104.6	185.9	Yes	27.0	41.5	12.3	18.8	94"x7.3"x8.5"	1.0	CineGrey	ZCTE84H
TE92HC2	92" (16:9)	45.1	80.2	114.6	203.7	Yes	42.6	57.8	19.3	26.2	103.3"x7.5"x9.75"	1.0	CineGrey	ZCTE92H
TE100HC2	100" (16:9)	49.1	87.2	124.7	221.5	Yes	45.9	61.2	20.8	27.7	107.4"x7.5"x9.75"	1.0	CineGrey	ZCTE100H
TE106HC2	106" (16:9)	52.0	92.4	132.1	234.7	No	47.8	64.4	21.7	29.2	115.5"x7.5"x9.75"	1.0	CineGrey	ZCTE106H
TE120HC2	121" (16:9)	58.9	104.6	149.6	265.7	No	52.7	70.6	23.9	32.0	130"x7.5"x9.75"	1.0	CineGrey	ZCTE120H
TE135HC2	135" (16:9)	66.2	117.7	168.1	299.0	No	52.9	73.4	24.0	33.3	141.8"x7.5"x9.75"	1.0	CineGrey	ZCTE135H
TE150HC2	150" (16:9)	73.6	130.7	186.9	332.0	No	58.4	79.4	26.5	36.0	155.17"x7.5"x9.75"	1.0	CineGrey	ZCTE150H
TE84HW2	84" (16:9)	41.2	73.2	104.6	185.9	Yes	27.0	41.5	12.3	18.8	94"x7.3"x8.5"	1.1	CineWhite	ZCTE84H
TE84HW2-E30	84" (16:9)	41.2	73.2	104.6	185.9	Yes	27.0	41.5	12.3	18.8	94"x7.3"x8.5"	1.1	CineWhite	ZCTE84H
TE92HW2	92" (16:9)	45.1	80.2	114.6	203.7	Yes	42.6	57.8	19.3	26.2	103.3"x7.5"x9.75"	1.1	CineWhite	ZCTE92H
TE100HW2	100" (16:9)	49.0	87.2	124.5	221.5	Yes	45.9	61.2	20.8	27.7	107.4"x7.5"x9.75"	1.1	CineWhite	ZCTE100H
TE100HW2-E24	100" (16:9)	49.0	87.2	124.5	221.5	Yes	45.9	61.2	20.8	27.7	107.4"x7.5"x9.75"	1.1	CineWhite	ZCTE100H
TE106HW2	106" (16:9)	52.0	92.4	132.1	234.7	No	47.8	64.4	21.7	29.2	115.5"x7.5"x9.75"	1.1	CineWhite	ZCTE106H
TE106HW2-E24	106" (16:9)	52.0	92.4	132.1	234.7	No	47.8	64.4	21.7	29.2	115.5"x7.5"x9.75"	1.1	CineWhite	ZCTE106H
TE110HW2	110" (16:9)	54.0	96.0	137.2	243.8	No	47.0	64.8	21.3	29.4	120.8"x7.5"x9.75"	1.1	CineWhite	ZCTE110H
TE110HW2-E24	110" (16:9)	54.0	96.0	137.2	243.8	No	47.2	64.8	21.4	29.4	120.8"x7.5"x9.75"	1.1	CineWhite	ZCTE110H
TE120HW2	121" (16:9)	58.9	104.6	149.6	265.7	No	52.7	70.6	23.9	32.0	130"x7.5"x9.75"	1.1	CineWhite	ZCTE120H
TE120HW2-E20	121" (16:9)	58.9	104.6	149.6	265.7	No	52.7	70.6	23.9	32.0	130"x7.5"x9.75"	1.1	CineWhite	ZCTE120H
TE135HW2	135" (16:9)	66.2	117.7	168.1	299.0	No	52.9	73.4	24.0	33.3	141.8"x7.5"x9.75"	1.1	CineWhite	ZCTE135H
TE135HW2-E12	135" (16:9)	66.2	117.7	168.1	299.0	No	52.9	73.4	24.0	33.3	141.8"x7.5"x9.75"	1.1	CineWhite	ZCTE135h
TE150HW2*	150" (16:9)*	73.5	130.7	186.7	332.0	No	58.4	79.4	26.5	36.0	155.17"x7.5"x9.75"	1.1	CineWhite	ZCTE150H
TE84HG2	84" (16:9)	41.2	73.2	104.6	185.9	Yes	27.0	41.5	12.3	18.8	94"x7.3"x8.5"	1.8	PowerGain	ZCTE84H
TE92HG2	92" (16:9)	45.1	80.2	114.6	203.7	Yes	42.6	57.8	19.3	26.2	103.3"x7.5"x9.75"	1.8	PowerGain	ZCTE92H
TE100HG2	100" (16:9)	49.0	87.2	124.5	221.5	Yes	45.9	61.2	20.8	27.7	107.4"x7.5"x9.75"	1.8	PowerGain	ZCTE100H
TE120HG2	121" (16:9)	58.8	104.6	149.4	265.7	No	52.7	70.6	23.9	32.0	130"x7.5"x9.75"	1.8	PowerGain	ZCTE120H
TE94XW2	94" (16:10)	49.8	79.7	126.5	202.4	No	37.5	52.9	17.0	24.0	103.3"x7.5"x9.75"	1.1	CineWhite	ZCTE94X
TE106XW2-E24	106" (16:10)	56.3	90.0	143.0	228.6	No	41.5	56.9	18.8	25.8	115"x 9.5"x7.5"	1.1	CineWhite	ZCTE106X
TE116XW2	116" (16:10)	61.5	98.4	156.2	249.9	No	50.3	68.8	22.8	31.2	123"x7.5"x9.5"	1.1	CineWhite	ZCTE116X
TE128XW2-E12	128" (16:10)	67.8	108.4	172.2	275.3	No	47.4	66.1	21.5	30.0	133.5"x7.5"x9.5"	1.1	CineWhite	ZCTE128X
TE139XW2	139" (16:10)	73.7	117.9	187.2	299.5	No	55.1	75.6	25.0	34.3	141.8"x7.5"x9.5"	1.1	CineWhite	ZCTE139X
TE85C-E30	85" (2.35:1)	33.0	77.6	83.8	197.0	Yes	30.7	43.9	13.9	19.9	261.62"x20.57"x19.05	1.1	CineWhite	ZCTE84C
TE96C-E24	96" (2.35:1)	37.5	88.1	95.3	223.8	No	39.4	55.1	17.9	25.0	113"x7.5"x9.5"	1.1	CineWhite	ZCTE96C
TE103C-E24	103" (2.35:1)	40.5	95.2	102.9	241.7	No	PLEASE VISIT ELITESCREENS.COM					CineWhite	ZCTE103C	
TE115C-E24	115" (2.35:1)	45.1	106.0	114.6	269.2	No	46.0	63.1	20.9	28.6	130.5"x7.5"x9.5"	1.1	CineWhite	ZCTE115C
TE125C-E20	125" (2.35:1)	49.0	115.2	124.5	292.5	No	50.1	68.3	22.7	31.0	139.8"x7.5"x9.5"	1.1	CineWhite	ZCTE125C
TE138C-E16	138" (2.35:1)	54.0	126.9	137.2	322.3	No	54.7	74.9	24.8	34.0	151.5"x7.5"x9.5"	1.1	CineWhite	ZCTE138C
TE153C-E12	153" (2.35:1)	60.0	141.0	152.4	358.1	No	60.7	82.4	27.5	37.4	165.50"x9.50"x7.50"	1.1	CineWhite	ZCTE153C

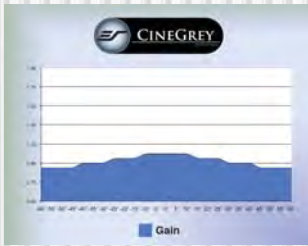

CineGrey is the best screen material for those using a low contrast ratio (LCD or DLP) projector for home theater and need to increase contrast ratio for enhanced black levels. We suggest you use CineWhite if you have a newer 2007-2008 model DLP or LCD projector.



AcousticPro1080™ is fiberglass backed and utilizes an acoustically transparent weave material that prevents sound absorption while its 1.0 gain wide diffusion material provides quality color reproduction and image clarity.

It is made for use with in-wall speakers and in commercial and residential applications

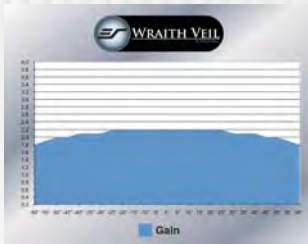

Wraith Veil Elite's rear projection screen material comes in 2.2 high gain to be used in ambient light environments, such as tradeshow, meeting rooms, and outside evening presentations. Its special surface coating enhances color reproduction and black level reproduction with wide diffusion for multiple applications. Optional seamless screen sizes are available up to 200" in 4:3 and 16:9 aspect ratios.

CineTension2 Series: Premium Rear Pro Electric/Motorized Screen with IR/RF/Wall Box

Model	Nominal Diagonal	View Height (in)	View Width (in)	View Height (cm)	View Width (cm)	UPS or FedEx	Net Weight (lbs)	Gross Weight (lbs)	Net Weight (kgs)	Gross Weight (kgs)	Packaging Dimension (LxHxW)	Gain	Screen Material	Optional Ceiling Trim Kit
TE84VR2	84" (4:3)	50.4	67.2	128.0	170.7	Yes	27.6	39.4	12.5	17.9	89.1"x6.5"x8"	2.2	Wraith Veil	ZCTET84V
TE92VR2	92" (4:3)	55.0	73.3	139.7	186.2	Yes	29.1	42.0	13.2	19.0	94"x7.3"x8.5"	2.2	Wraith Veil	ZCTE92V
TE100VR2	100" (4:3)	60.0	80.0	152.4	203.2	Yes	43.0	59.5	19.5	27.0	103.5"x7.5"x9.75"	2.2	Wraith Veil	ZCTE100V
TE120VR2	120" (4:3)	72.0	96.0	182.9	243.8	No	47.8	65.5	21.7	29.7	120.7"x7.5"x9.75"	2.2	Wraith Veil	ZCTE120V
TE135VR2	135" (4:3)	81.0	108.0	205.7	274.3	No	PLEASE VISIT ELITESCREENS.COM					2.2	Wraith Veil	ZCTE135V
TE150VR2	150" (4:3)	90.0	120.0	228.6	304.8	No	PLEASE VISIT ELITESCREENS.COM					2.2	Wraith Veil	ZCTE150V
TE180VR2	180" (4:3)	108.0	144.0	274.3	365.8	No	PLEASE VISIT ELITESCREENS.COM					2.2	Wraith Veil	N/A
TE84HR2	84" (16:9)	41.2	73.2	104.6	185.9	Yes	27.0	41.5	12.3	18.8	94"x7.3"x8.5"	2.2	Wraith Veil	ZCTE84H
TE92HR2	92" (16:9)	45.1	80.2	114.6	203.7	Yes	42.6	57.8	19.3	26.2	103.3"x7.5"x9.75"	2.2	Wraith Veil	ZCTE92H
TE106HR2	106" (16:9)	52.0	92.4	132.1	234.7	No	45.9	61.2	20.8	27.7	107.4"x7.5"x9.75"	2.2	Wraith Veil	ZCTE106H
TE120HR2	121" (16:9)	58.8	104.6	149.4	265.7	No	52.7	70.6	23.9	32.0	130"x7.5"x9.75"	2.2	Wraith Veil	ZCTE120H
TE135HR2	135" (16:9)	66.2	117.7	168.1	299.0	No	52.9	73.4	24.0	33.3	141.8"x7.5"x9.75"	2.2	Wraith Veil	ZCTE135H
TE150HR2	150" (16:9)	73.6	130.7	186.9	332.0	No	PLEASE VISIT ELITESCREENS.COM					2.2	Wraith Veil	ZCTE150H
TE165HR2	165" (16:9)	81.0	144.0	205.7	365.8	No	PLEASE VISIT ELITESCREENS.COM					2.2	Wraith Veil	N/A
TE180HR2	180" (16:9)	88.3	156.9	224.3	398.5	No	PLEASE VISIT ELITESCREENS.COM					2.2	Wraith Veil	N/A
TE200HR2	200" (16:9)	98.0	174.0	248.9	442.0	No	PLEASE VISIT ELITESCREENS.COM					2.2	Wraith Veil	N/A

CineTension2 AcousticPro Series: Premium Tension Electric Acoustic Sound Transparent Screen IR/RF/Wall Box/12V Trigger

Model	Nominal Diagonal	View Height (in)	View Width (in)	View Height (cm)	View Width (cm)	UPS or FedEx	Net Weight (lbs)	Gross Weight (lbs)	Net Weight (kgs)	Gross Weight (kgs)	Packaging Dimension (LxHxW)	Gain	Screen Material	Optional Ceiling Trim Kit
TE84VW2-A	84" (4:3)	50.4	67.2	128.0	170.7	Yes	27.6	39.4	12.5	17.9	89.1"x6.5"x8"	1.0	AcousticPro	ZCTE84V
TE120VW2-A	120" (4:3)	72.0	96.0	182.9	243.8	No	47.8	65.5	21.7	29.7	120.7"x7.5"x9.75"	1.0	AcousticPro	ZCTE120V
TE135VW2-A	135" (4:3)	81.0	108.0	205.7	274.3	No	51.5	70.6	23.4	32.0	132.8"x7.5"x9.75"	1.0	AcousticPro	ZCTE135V
TE92HW2-A	92" (16:9)	45.1	80.2	114.6	203.7	Yes	42.6	57.8	19.3	26.2	103.3"x7.5"x9.75"	1.0	AcousticPro	ZCTE92H
TE120HW2-A	120" (16:9)	58.9	104.6	149.6	265.7	No	52.7	70.6	23.9	32.0	130"x7.5"x9.75"	1.0	AcousticPro	ZCTE120H
TE135HW2-A	135" (16:9)	66.2	117.7	168.1	299.0	No	52.9	73.4	24.0	33.3	141.8"x7.5"x9.75"	1.0	AcousticPro	ZCTE135H
TE150HW2-A	150" (16:9)	73.6	130.7	186.9	332.0	No	58.4	79.4	26.5	36.0	155.17"x7.5"x9.75"	1.0	AcousticPro	ZCTE150H

CineTension2 AcousticPro1080 Series: Premium Tension Electric Acoustic Sound Transparent Screen IR/RF/Wall Box/12V Trigger

Model	Nominal Diagonal	View Height (in)	View Width (in)	View Height (cm)	View Width (cm)	UPS or FedEx	Net Weight (lbs)	Gross Weight (lbs)	Net Weight (kgs)	Gross Weight (kgs)	Packaging Dimension (LxHxW)	Gain	Screen Material	Optional Ceiling Trim Kit
TE100VW2-A1080	100" (4:3)	60.0	80.0	152.4	203.2	Yes	43.0	59.5	19.5	27.0	103.5"x7.5"x9.75"	1.0	AcousticPro1080	ZCTE100V
TE120VW2-A1080	120" (4:3)	72.0	96.0	182.9	243.8	No	47.8	65.5	21.7	29.7	120.7"x7.5"x9.75"	1.0	AcousticPro1080	ZCTE120V
TE135VW2-A1080	135" (4:3)	81.0	108.0	205.7	274.3	No	51.5	70.6	23.4	32.0	132.8"x7.5"x9.75"	1.0	AcousticPro1080	ZCTE135V
TE84HW2-A1080	84" (16:9)	41.2	73.2	104.6	185.9	Yes	27.0	41.5	12.3	18.8	94"x7.3"x8.5"	1.0	AcousticPro1080	ZCTE84H
TE92HW2-A1080	92" (16:9)	45.1	80.2	114.6	203.7	Yes	42.6	57.8	19.3	26.2	103.3"x7.5"x9.75"	1.0	AcousticPro1080	ZCTE92H
TE120HW2-A1080	120" (16:9)	58.9	104.6	149.6	265.7	No	52.7	70.6	23.9	32.0	130"x7.5"x9.75"	1.0	AcousticPro1080	ZCTE120H
TE135HW2-A1080	135" (16:9)	66.2	117.7	168.1	299.0	No	52.9	73.4	24.0	33.3	141.8"x7.5"x9.75"	1.0	AcousticPro1080	ZCTE135H
TE150HW2-A1080	150" (16:9)	73.6	130.7	186.9	332.0	No	58.4	79.4	26.5	36.0	155.17"x7.5"x9.75"	1.0	AcousticPro1080	ZCTE150H

CineTension2 Series Dimensions Table

Model	Case Length (A)	Screen Width (A1)	View Width (A2)	Weight Bar Length (A3)	Bottom Edge (B4)	Material to Weight Bar Height (B2)	View Height (B3)	Overall Height (B1)	Overall Height w/Bracket (B)	Case Height (B5)	B6	Case Width (C)	Case End to Screen (C1)	C2	G1	G2	G3	G4	G5	G6	G7	G8
TE84H	2260.6	2037.1	1859.3	2141.0	87	1281.0	1046.0	1391.0	1431.0	94.0	105	97	20.1	132	70.1	37.1	22.1	11.9	73.4	39.9	20.1	9.9
TE84H-E30	2260.6	2037.1	1859.3	2141.0	87	1894.8	1046.0	2006.6	2044.7	94.0	105	97	20.1	132	70.1	37.1	22.1	11.9	73.4	39.9	20.1	9.9
TE92H	2439.0	2214.9	2037.1	2345.0	96	1394.0	1145.5	1529.0	1579.0	116.0	175	128	24.0	132	87.1	47.0	35.1	17.5	103.0	55.0	20.1	9.9
TE100H	2617.0	2392.7	2214.9	2455.0	96	1489.0	1245.4	1628.0	1678.0	116.0	175	128	24.0	132	87.1	47.0	35.1	17.5	103.1	55.1	20.1	9.9
TE100H-E24	2617.0	2391.7	2214.9	2455.0	96	1950.7	1245.0	2090.4	2141.2	116.0	175	128	24.0	132	87.1	47.0	35.1	17.5	103.1	55.1	20.1	9.9
TE106H	2770.0	2524.8	2347.0	2625.0	96	1564.0	1320.0	1703.0	1753.0	116.0	175	128	24.0	132	87.1	47.0	35.1	17.5	103.1	55.1	20.1	9.9
TE106H-E24	2770.0	2524.0	2347.0	2625.0	96	2024.0	1320.0	2163.0	2213.0	116.0	175	128	24.0	132	87.1	47.0	35.1	17.5	103.1	55.1	20.1	9.9
TE110H	2882.9	2613.7	2435.9	2722.9	96	1612.9	1369.1	1750.1	1800.9	116.0	176	128	24.0	132	87.1	47.0	35.1	17.5	103.1	55.1	20.1	9.9
TE110H-E24	2882.9	2613.7	2435.9	2722.9	96	2075.2	1369.1	2214.9	2265.7	116.0	175	128	24.0	132	87.1	47.0	35.1	17.5	103.1	55.1	20.1	9.9
TE120H	3114.0	2834.6	2656.8	2945.0	96	1688.0	1494.0	1826.0	1876.0	116.0	175	128	24.0	132	87.1	47.0	35.1	17.5	103.1	55.1	20.1	9.9
TE120H-E20	3114.0	2834.6	2656.8	2945.0	96	2098.0	1494.0	2237.7	2288.5	116.0	175	128	24.0	132	87.1	47.0	35.1	17.5	103.1	55.1	20.1	9.9
TE135H	3441.0	3167.0	2989.0	3255.0	96	1875.0	1681.0	2013.0	2063.0	116.0	175	128	24.0	132	87.1	47.0	35.1	17.5	103.1	55.1	20.1	9.9
TE135H-E12	3441.0	3167.0	2989.0	3255.0	96	2098.0	1681.0	2237.7	2288.5	116.0	175	128	24.0	132	87.1	47.0	35.1	17.5	103.1	55.1	20.1	9.9
TE150H	3804.0	3498.6	3320.8	3610.0	96	2062.0	1868.0	2200.0	2250.0	116.0	175	128	24.0	132	87.1	47.0	35.1	17.5	103.1	55.1	20.1	9.9
TE84V	2109.0	1884.7	1706.9	1995.0	87	1515.0	1280.0	1625.0	1665.0	94.0	105	97	20.0	132	70.1	37.1	22.1	11.9	73.4	39.9	20.1	9.9
TE84V-E30	2109.0	1884.7	1706.9	1995.0	87	2128.5	1280.2	2240.3	2280.9	94.0	105	97	20.0	132	70.1	37.1	22.1	11.9	73.4	39.9	20.1	9.9
TE92V	2260.6	2047.2	1869.4	2141.2	87	1640.8	1402.1	1752.6	1793.2	94.0	105	97	20.0	132	70.1	37.1	22.1	11.9	73.4	39.9	20.1	9.9
TE100V	2439.0	2209.8	2032.0	2305.0	96	1768.0	1524.0	1905.8	1955.0	116.0	175	128	24.0	132	87.1	47.0	35.1	17.5	103.1	55.1	20.1	9.9
TE120V	2882.0	2616.2	2438.4	2725.0	96	2022.0	1828.0	2160.0	2210.0	116.0	175	128	24.0	132	87.1	47.0	35.1	17.5	103.1	55.1	20.1	9.9
TE135V	3186.9	2921.0	2743.2	3040.0	96	2251.0	2057.0	2389.0	2439.0	116.0	175	128	24.0	132	87.1	47.0	35.1	17.5	103.1	55.1	20.1	9.9
TE150V	3511.0	3225.8	3048.0	3365.0	97	2480.0	2286.0	2618.0	2668.0	116.1	175	128	24.0	132	87.1	47.0	35.1	17.5	103.1	55.1	20.1	9.9
TE94X	2439.0	2202.2	2024.4	2296.2	96	1508.8	1264.9	1645.9	1696.7	116.1	176	128	24.0	132	87.1	47.0	35.1	17.5	103.1	55.1	20.1	9.9
TE106X-E24	PLEASE VISIT ELITESCREENS.COM													132	87.1	47.0	35.1	17.5	103.1	55.1	20.1	9.9
TE116X	2934.0	2677.2	2499.4	2771.1	96	1805.9	1562.1	1943.1	1993.9	116.1	177	128	24.0	132	87.1	47.0	35.1	17.5	103.1	55.1	20.1	9.9
TE128X-E12	PLEASE VISIT ELITESCREENS.COM													132	87.1	47.0	35.1	17.5	103.1	55.1	20.1	9.9
TE139X	3441.0	3172.0	2994.0	3255.0	96	2061.0	1871.0	2177.1	2227.1	116.1	176	128	24.0	132	87.1	47.0	35.1	17.5	103.1	55.1	20.1	9.9
TE85C-E30	2328.5	2176.5	1986.5	2266.5	87	1694.2	845.2	1804.2	1844.2	94.0	105	97	24.0	132	70.1	37.1	22.1	11.9	73.4	39.9	20.1	9.9
TE96C-E24	2668.6	2433.6	2243.6	2523.6	96	1660.2	954.6	1798.2	1848.2	116.1	176	128	24.0	132	87.1	47.0	35.1	17.5	103.1	55.1	20.1	9.9
TE103C-E24	2882.9	2597.2	2407.2	2725.4	96	1729.8	1024.2	1867.8	1917.8	116.1	176	128	24.0	132	87.1	47.0	35.1	17.5	103.1	55.1	20.1	9.9
TE115C-E24	3112.6	2877.6	2687.6	2967.6	96	1849.2	1143.6	1987.2	2037.2	116.1	176	128	24.0	132	87.1	47.0	35.1	17.5	103.1	55.1	20.1	9.9
TE125C-E20	3346.3	3111.3	2921.3	3201.3	96	1847.0	1243.0	1985.0	2035.0	116.1	176	128	24.0	132	87.1	47.0	35.1	17.5	103.1	55.1	20.1	9.9
TE138C-E16	3650.1	3415.1	3225.1	3505.1	96	1874.7	1372.3	2012.7	2062.7	116.1	176	128	24.0	132	87.1	47.0	35.1	17.5	103.1	55.1	20.1	9.9
TE153C-E12	4000.7	3765.7	3575.7	3855.7	96	1922.2	1521.4	2060.2	2110.2	116.1	176	128	24.0	132	87.1	47.0	35.1	17.5	103.1	55.1	20.1	9.9

Unit: mm

Can't find size and ratio you're looking for? Visit elitescreens.com/csr to create your own

The listed measurements are for general reference only. Please contact Elite Screens to verify product design and dimensions before attempting to integrate its products with any structural or furniture modification. Although a manufacturer may offer product advice, it may be taken or disregarded at the integrator's discretion. Elite Screens will not be held responsible or be otherwise liable for faulty installations.

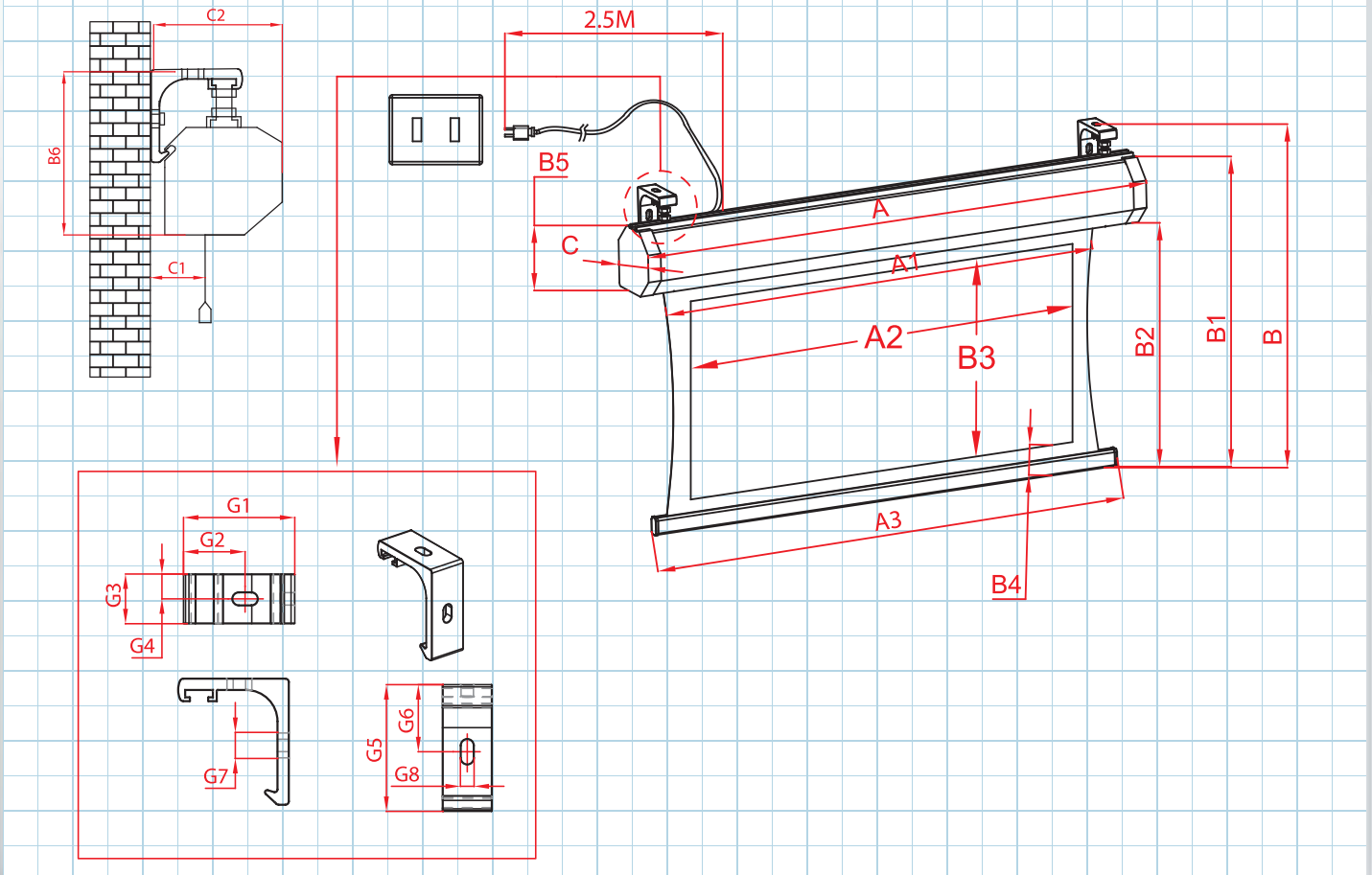

CineTension2 Series Dimensions Table

Model	Case Length (A)	Screen Width (A1)	View Width (A2)	Weight Bar Length (A3)	Bottom Edge (B4)	Material to Weight Bar Height (B2)	View Height (B3)	Overall Height (B1)	Overall Height w/Bracket (B)	Case Height (B5)	B6	Case Width (C)	Case End to Screen (C1)	C2	G1	G2	G3	G4	G5	G6	G7	G8
TE84H	89.0	80.2	73.2	84.3	3.4	50.4	41.2	54.8	56.3	3.7	4.1	3.8	0.8	5.2	2.8	1.5	0.9	0.5	2.9	1.6	0.8	0.4
TE84H-E30	89.0	80.2	73.2	84.3	3.4	74.6	41.2	79.0	80.5	3.7	4.1	3.8	0.8	5.2	2.8	1.5	0.9	0.5	2.9	1.6	0.8	0.4
TE92H	96.0	87.2	80.2	92.3	3.8	54.9	45.1	60.2	62.2	4.6	6.9	5.0	0.9	5.2	3.4	1.9	1.4	0.7	4.1	2.2	0.8	0.4
TE100H	103.0	94.2	87.2	96.7	3.8	58.6	49.0	64.1	66.1	4.6	6.9	5.0	0.9	5.2	3.4	1.9	1.4	0.7	4.1	2.2	0.8	0.4
TE100H-E24	103.0	94.2	87.2	96.7	3.8	76.8	49.0	82.3	84.3	4.6	6.9	5.0	0.9	5.2	3.4	1.9	1.4	0.7	4.1	2.2	0.8	0.4
TE106H	109.1	99.4	92.4	103.3	3.8	61.6	52.0	67.0	69.0	4.6	6.9	5.0	0.9	5.2	3.4	1.9	1.4	0.7	4.1	2.2	0.8	0.4
TE106H-E24	109.1	99.4	92.4	103.3	3.8	79.7	52.0	85.2	87.1	4.6	6.9	5.0	0.9	5.2	3.4	1.9	1.4	0.7	4.1	2.2	0.8	0.4
TE110H	113.5	102.9	95.9	107.2	3.8	63.5	53.9	68.9	70.9	4.6	6.9	5.0	0.9	5.2	3.4	1.9	1.4	0.7	4.1	2.2	0.8	0.4
TE110H-E24	113.5	102.9	95.9	107.2	3.8	81.7	53.9	87.2	89.2	4.6	6.9	5.0	0.9	5.2	3.4	1.9	1.4	0.7	4.1	2.2	0.8	0.4
TE120H	122.6	111.6	104.6	115.9	3.8	66.5	58.8	71.9	73.9	4.6	6.9	5.0	0.9	5.2	3.4	1.9	1.4	0.7	4.1	2.2	0.8	0.4
TE120H-E20	122.6	111.6	104.6	115.9	3.8	82.6	58.8	88.1	90.1	4.6	6.9	5.0	0.9	5.2	3.4	1.9	1.4	0.7	4.1	2.2	0.8	0.4
TE135H	135.5	124.7	117.7	128.1	3.8	73.8	66.2	79.3	81.2	4.6	6.9	5.0	0.9	5.2	3.4	1.9	1.4	0.7	4.1	2.2	0.8	0.4
TE135H-E12	135.5	124.7	117.7	128.1	3.8	82.6	66.2	88.1	90.1	4.6	6.9	5.0	0.9	5.2	3.4	1.9	1.4	0.7	4.1	2.2	0.8	0.4
TE150H	149.8	137.7	130.7	142.1	3.8	81.2	73.5	86.6	88.6	4.6	6.9	5.0	0.9	5.2	3.4	1.9	1.4	0.7	4.1	2.2	0.8	0.4
TE84V	83.0	74.2	67.2	78.5	3.4	59.6	50.4	64.0	65.6	3.7	4.1	3.8	0.8	5.2	2.8	1.5	0.9	0.5	2.9	1.6	0.8	0.4
TE84V-E30	83.0	74.2	67.2	78.5	3.4	83.8	50.4	88.2	89.8	3.7	4.1	3.8	0.8	5.2	2.8	1.5	0.9	0.5	2.9	1.6	0.8	0.4
TE92V	89.0	80.6	73.6	84.3	3.4	64.6	55.2	69.0	70.6	3.7	4.1	3.8	0.8	5.2	2.8	1.5	0.9	0.5	2.9	1.6	0.8	0.4
TE100V	96.0	87.0	80.0	90.7	3.8	69.6	60.0	75.0	77.0	4.6	6.9	5.0	0.9	5.2	3.4	1.9	1.4	0.7	4.1	2.2	0.8	0.4
TE120V	113.5	103.0	96.0	107.3	3.8	79.6	72.0	85.0	87.0	4.6	6.9	5.0	0.9	5.2	3.4	1.9	1.4	0.7	4.1	2.2	0.8	0.4
TE135V	125.5	115.0	108.0	119.7	3.8	88.6	81.0	94.1	96.0	4.6	6.9	5.0	0.9	5.2	3.4	1.9	1.4	0.7	4.1	2.2	0.8	0.4
TE150V	138.2	127.0	120.0	132.5	3.8	97.6	90.0	103.1	105.0	4.6	6.9	5.0	0.9	5.2	3.4	1.9	1.4	0.7	4.1	2.2	0.8	0.4
TE94X	96.0	86.7	79.7	90.4	3.8	59.4	49.8	64.8	66.8	4.6	6.9	5.0	0.9	5.2	3.4	1.9	1.4	0.7	4.1	2.2	0.8	0.4
TE106X-E24	PLEASE VISIT ELITESCREENS.COM													5.2	3.4	1.9	1.4	0.7	4.1	2.2	0.8	0.4
TE116X	115.5	105.4	98.4	109.1	3.8	71.1	61.5	76.5	78.5	4.6	7.0	5.0	0.9	5.2	3.4	1.9	1.4	0.7	4.1	2.2	0.8	0.4
TE128X-E12	PLEASE VISIT ELITESCREENS.COM													5.2	3.4	1.9	1.4	0.7	4.1	2.2	0.8	0.4
TE139X	135.5	124.9	117.9	128.1	3.8	81.1	73.7	85.7	87.7	4.6	6.9	5.0	0.9	5.2	3.4	1.9	1.4	0.7	4.1	2.2	0.8	0.4
TE85C-E30	91.7	85.7	78.2	89.2	3.4	66.7	33.3	71.0	72.6	3.7	4.1	3.8	0.8	5.2	2.8	1.5	0.9	0.5	2.9	1.6	0.8	0.4
TE96C-E24	105.1	95.8	88.3	99.4	3.8	65.4	37.6	70.8	72.8	4.6	6.9	5.0	0.9	5.2	3.4	1.9	1.4	0.7	4.1	2.2	0.8	0.4
TE103C-E24	113.5	102.3	94.8	107.3	3.8	68.1	40.3	73.5	75.5	4.6	6.9	5.0	0.9	5.2	3.4	1.9	1.4	0.7	4.1	2.2	0.8	0.4
TE115C-E24	122.5	113.3	105.8	116.8	3.8	72.8	45.0	78.2	80.2	4.6	6.9	5.0	0.9	5.2	3.4	1.9	1.4	0.7	4.1	2.2	0.8	0.4
TE125C-E20	131.7	122.5	115.0	126.0	3.8	72.7	48.9	78.1	80.1	4.6	6.9	5.0	0.9	5.2	3.4	1.9	1.4	0.7	4.1	2.2	0.8	0.4
TE138C-E16	143.7	134.5	127.0	138.0	3.8	73.8	54.0	79.2	81.2	4.6	6.9	5.0	0.9	5.2	3.4	1.9	1.4	0.7	4.1	2.2	0.8	0.4
TE153C-E12	157.5	148.3	140.8	151.8	3.8	75.7	59.9	81.1	83.1	4.6	6.9	5.0	0.9	5.2	3.4	1.9	1.4	0.7	4.1	2.2	0.8	0.4

Unit: inch

Can't find size and ratio you're looking for? Visit elitescreens.com/csr to create your own

The listed measurements are for general reference only. Please contact Elite Screens to verify product design and dimensions before attempting to integrate its products with any structural or furniture modification. Although a manufacturer may offer product advice, it may be taken or disregarded at the integrator's discretion. Elite Screens will not be held responsible or be otherwise liable for faulty installations.

