

## **PLEASE READ**

This manual is provided as a free service by Projector.com.

We are in no way responsible for the contents of the manual. We do not guarantee its accuracy and we do not make any claim of copyright. The copyright remains the property of their respective owners.

## **ABOUT PROJECTOR.COM**

Projector.com (<http://www.projector.com>) is your review and buying guide resource for DLP and LCD video projectors.

Visit the site to read the latest projector news and reviews, read and comment on projector specifications, download user manuals and much more.

# HITACHI

Projector

## CP-S235

# User's Manual - Operating Guide

Thank you for purchasing this projector.



**WARNING** Before using, read the "User's Manual - Safety Guide" and these manuals to ensure correct usage through understanding. After reading, store them in a safe place for future reference.

### NOTE

- The information in this manual is subject to change without notice.
- The manufacturer assumes no responsibility for any errors that may appear in this manual.
- The reproduction, transmission or use of this document or contents is not permitted without express written authority.

### TRADEMARK ACKNOWLEDGMENT :

- VGA and XGA are registered trademarks of the International Business Machines Corporation.
- Apple and Mac are registered trademarks of Apple Computer, Inc.
- VESA and SVGA are trademarks of the Video Electronics Standard Association.
- Windows is a registered trademark of Microsoft Corporation.

All other trademarks are the property of their respective owners.

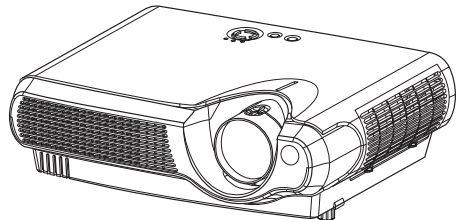

# Contents

<b>Projector Features</b> .....	<b>3</b>	<b>Multifunctional Settings</b> .....	<b>22</b>
<b>Preparation</b> .....	<b>3</b>	Using The Menu Functions .....	22
<b>Part Names</b> .....	<b>4</b>	MAIN Menu .....	23
The Projector .....	4	PICTURE-1 Menu .....	24
Fastening The Lens Cap .....	4	PICTURE-2 Menu .....	26
The Remote Control .....	6	INPUT Menu .....	27
<b>Setting Up</b> .....	<b>7</b>	AUTO Menu .....	29
Arrangement .....	7	SCREEN Menu .....	30
Adjusting The Projector's		OPTION Menu .....	31
Elevator .....	8	<b>Operating The PC Screen</b> .....	<b>32</b>
Connecting Your Devices .....	9	<b>Lamp</b> .....	<b>33</b>
Connecting Power Supply .....	11	Replacing The Lamp .....	34
<b>Remote Control</b> .....	<b>12</b>	<b>Air Filter</b> .....	<b>35</b>
Putting Batteries .....	12	Caring For The Air Filter .....	35
Operating The Remote Control .....	13	Replacing The Air Filter .....	36
<b>Power ON/OFF</b> .....	<b>14</b>	<b>Other Care</b> .....	<b>37</b>
Turning On The Power .....	14	Caring For The Inside	
Selecting An Input Signal .....	15	Of The Projector .....	37
Turning Off The Power .....	16	Caring For The Lens .....	37
<b>Operating</b> .....	<b>17</b>	Caring For The Cabinet	
Adjusting The Volume .....	17	And Remote Control .....	37
Temporarily Muting The Sound .....	17	<b>Troubleshooting</b> .....	<b>38</b>
Adjusting The Position .....	18	Related Messages .....	38
Using The Automatic		Regarding	
Adjustment Feature .....	19	The Indicator Lamps .....	40
Correcting Keystone		Phenomena That May Easily Be	
Distortions .....	19	Mistaken For Machine Defects .....	42
Using The Magnify Feature .....	20	Warranty And After-Service .....	43
Freezing The Screen .....	20	<b>Specifications</b> .....	<b>44</b>
Signal Searching .....	21		
Selecting The Aspect Ratio .....	21		
Temporarily Blanking			
The Screen .....	21		

## Projector Features

This multimedia projector is used to project various computer signals as well as NTSC / PAL / SECAM video signals onto a screen. Little space is required for installation and large images can easily be realized.

### ● **Ultra High Brightness**

Crisp, ultra-bright presentations is achieved by using a UHB (ultra high brightness) lamp and a highly efficient optical system.

### ● **Whisper Mode Equipped**

Special mode is available for reducing projector noise to achieve quieter operation.

### ● **User Memory Function**

This projector can memorize 4 settings by MY MEMORY function.

### ● **Partial Magnification Function**

Interesting parts of images can be magnified for closer viewing.

### ● **Keystone Distortion Correction**

Quick correction of distorted images electrically.

## Preparation

Please see the “Contents Of Package” of the “User’s Manual – Quick Guide”. Your projector should come with the items shown there. Contact your dealer anything is missing.

**NOTE** • Keep the original packing material for future reshipment.

## Part Names

### The Projector

 Indicates the corresponding reference page

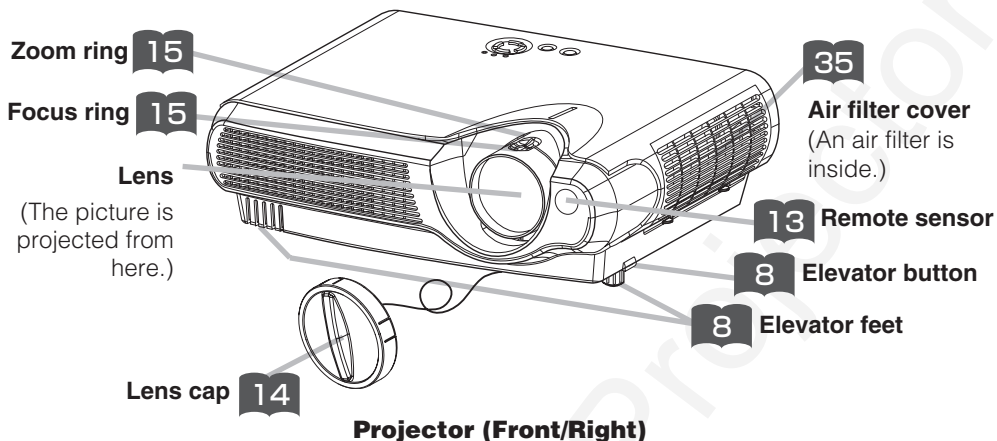

### Fastening The Lens Cap

To avoid losing, please fasten the lens cap to the projector using the strap.

- 1** Fix the strap to the strap ring of lens cap, as the right drawing.

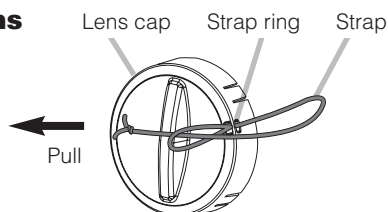

- 2** Put one piece of the strap into the groove on rivet, as the right drawing.

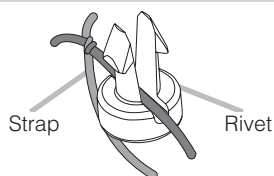

- 3** Push the rivet into the strap hole.

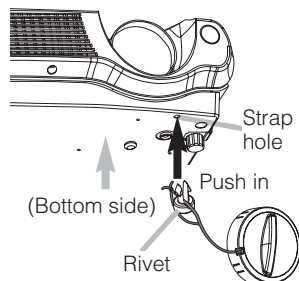

# Part Names (continued)

## The Projector (continued)

### INPUT button 15

toggles between the signal ports.

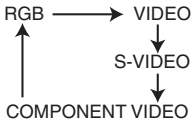

### STANDBY/ON button 14

prepares for turning the power on/off. Refer to the section "Power ON/OFF".

### POWER indicator 14

tells the state of power supply. Refer to the section "Power ON/OFF".

### 40 TEMP indicator

lights or blinks when any problem about internal temperature has happened.

### 40 LAMP indicator

lights or blinks when any problem about the lamp has happened.

### 22 MENU buttons

operate the menu function.

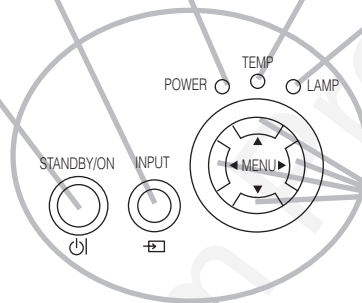

### AUDIO R port 10

### L port 10

(from a video equipment)

### S-VIDEO port 10

### AUDIO OUT port 10

### AUDIO IN port 10

(from a computer)

### VIDEO port 10

### COMPONENT VIDEO - Y 10

### COMPONENT VIDEO - Cb/Pb 10

### COMPONENT VIDEO - Cr/Pr 10

### 10 RGB OUT port

### 10 USB port

### 10 RGB IN port

### 14 Power switch

### 11 AC inlet

### 10 CONTROL port

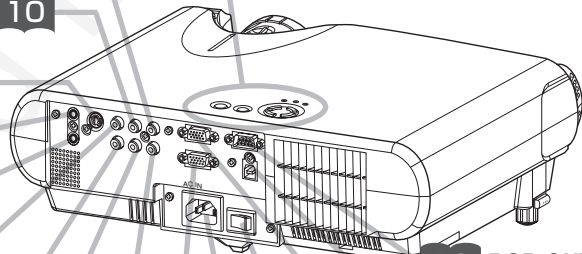

**Projector (Rear/Left)**

## Part Names (continued)

### The Remote Control

#### RGB button 15

selects the input signal of RGB port.

#### VIDEO button 15

toggles between the signal ports of VIDEO, S-VIDEO and COMPONENT VIDEO.

#### ASPECT button 21

toggles between the modes for aspect ratio.

#### MAGNIFY ON/OFF buttons 20

turns on/off the MAGNIFY mode.



In the MAGNIFY mode,  
**To move the magnified area,**

(1) Press the POSITION button.

(2) Use the cursor buttons to move the picture.

(3) Press the POSITION button again to finish.

**To shift the magnify level,**

use the cursor  /  buttons.

#### FREEZE button 20

freezes/reactivates the picture.

#### POSITION button 18

turns on/off the POSITION mode. (for RGB input)

In the POSITION mode,  
**To move the picture,**  
use the cursor buttons.

#### ESC button 22

returns to the previous display at the menu functions.

( Available for operating PC screen)

#### SEARCH button 21

searches for an input signal between the following signal ports of RGB, VIDEO, S-VIDEO and COMPONENT VIDEO.

#### 14 (STANDBY/ON) button

prepares for turning the power on/off.

#### 19 AUTO button



executes automatic adjustment.

#### 21 BLANK button

blanks the screen temporarily.

#### 17 VOLUME button

turns on/off the VOLUME mode.

In the VOLUME mode,  
**To adjust the volume,**  
use the cursor  /  buttons.

#### 32 KEYBOARD button

operate the PC screen.



#### 17 MUTE button

mutes/restores the sound.

#### 19 KEYSTONE button

turns on/off the KEYSTONE mode.

In the KEYSTONE mode,  
**To adjust the keystone,**

use the cursor  /  buttons.

#### 22 MENU button

opens/closes the menu.

#### 22 RESET button

cancels the adjustment in progress.

\* The adjustments of the volume etc. are not reset.

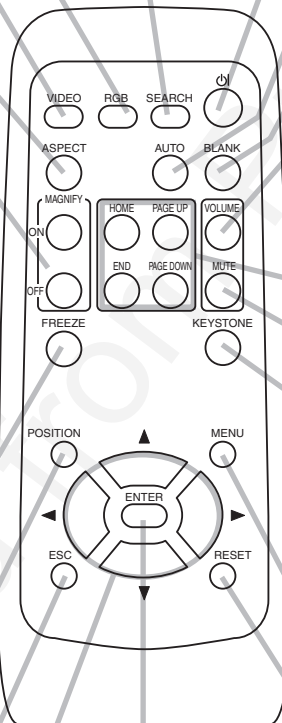

#### 22 ENTER button

proceeds to the next operation at the menu functions.

( Available for operating PC screen)

#### 22 , , , (Cursor) buttons

works for adjusting or menu controlling.

( Available for operating PC screen)

# Setting Up

## Arrangement

- ⚠ WARNING** • Install the projector in a suitable environment according to instructions of the “User’s Manual – Safety Guide” and this manual.
- The power outlet should be close to the projector and easily accessible.

Refer to the illustrations and tables below to determine the screen size and projection distance.

The values shown in the table are calculated for a full size screen:800×600

(a):Distance from the projector to the screen (±10%)

(b):Distance from the lens center to the bottom of the screen (±10%)

(c):Distance from the lens center to the top of the screen (±10%)

### Reference for the 4:3 aspect ratio

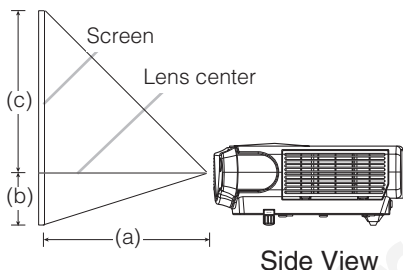

Screen Size [inch (m)]	(a) [inch (m)]		(b) [inch (cm)]	(c) [inch (cm)]
	Min.	Max.		
30 (0.8)	35(0.9)	42(1.1)	2(5)	16(41)
40 (1.0)	47(1.2)	56(1.4)	2(6)	22(55)
50 (1.3)	59(1.5)	71(1.8)	3(8)	27(69)
60 (1.5)	71(1.8)	85(2.2)	4(9)	32(82)
70 (1.8)	83(2.1)	99(2.5)	4(11)	38(96)
80 (2.0)	95(2.4)	114(2.9)	5(12)	43(110)
90 (2.3)	107(2.7)	128(3.3)	5(14)	49(123)
100 (2.5)	119(3.0)	143(3.6)	6(15)	54(137)
120 (3.0)	143(3.6)	171(4.4)	7(18)	65(165)
150 (3.8)	179(4.6)	215(5.5)	9(23)	81(206)
200 (5.0)	240(6.1)	287(7.3)	12(30)	108(274)
250 (6.3)	300(7.6)	359(9.1)	15(38)	135(343)
300 (7.5)	360(9.1)	431(10.9)	18(46)	162(411)

### Reference for the 16:9 aspect ratio

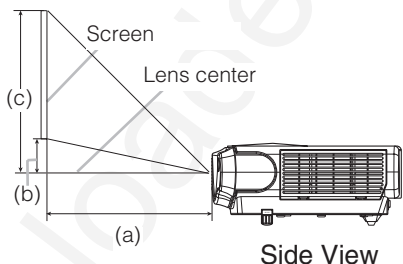

Screen Size [inch (m)]	(a) [inch (m)]		(b) [inch (cm)]	(c) [inch (cm)]
	Min.	Max.		
30 (0.8)	38(1.0)	46(1.2)	0(1)	15(39)
40 (1.0)	51(1.3)	61(1.6)	1(2)	20(51)
50 (1.3)	64(1.6)	77(2.0)	1(2)	25(64)
60 (1.5)	77(2.0)	93(2.4)	1(2)	30(77)
70 (1.8)	90(2.3)	108(2.8)	1(3)	35(90)
80 (2.0)	104(2.6)	124(3.2)	1(3)	41(103)
90 (2.3)	117(3.0)	140(3.6)	1(4)	46(116)
100 (2.5)	130(3.3)	155(3.9)	2(4)	51(129)
120 (3.0)	156(4.0)	187(4.7)	2(5)	61(154)
150 (3.8)	196(5.0)	234(5.9)	2(6)	76(193)
200 (5.0)	216(6.6)	312(7.9)	3(8)	101(257)
250 (6.3)	327(8.3)	391(9.9)	4(10)	127(322)
300 (7.5)	393(10.0)	469(11.9)	5(12)	152(386)



## Setting Up (continued)

### **Adjusting The Projector's Elevator**

**⚠ CAUTION** • If you press the elevator buttons without holding the projector, the projector might crash down, overturn, smash your fingers and possibly result in malfunction. To prevent damaging the projector and injuring yourself, **ALWAYS HOLD THE PROJECTOR** whenever using the elevator buttons to adjust the elevator feet.

You can use the elevator feet to make adjustments if the surface on which you need to set the projector is uneven or if you otherwise need to adjust the angle of projection. The adjustment range of the elevator feet is 0 to 9 degrees.

**1 Press and hold in the elevator buttons.**

**2 Raise or lower the projector to the desired height and then release the elevator buttons.**

When you release the elevator buttons, the elevator feet will lock into position.

**3 As necessary, you can also finely adjust the height of the projector by twisting the elevator feet by hand.**

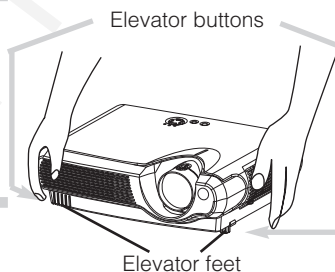

## Setting Up (continued)

### Connecting Your Devices

**⚠ WARNING** • Incorrect connecting could result in fire or electrical shock. Whenever attempting to connect other devices to the projector, please thoroughly read the "User's Manual - Safety Guide", this manual and the manual of each device to be connected.

**⚠ CAUTION** • TURN OFF ALL DEVICES prior to connecting them to the projector. Attempting to connect a live device to the projector may generate extremely loud noises or other abnormalities that may result in malfunction and/or damage to the device and/or projector.

**ATTENTION** • Make sure that you connect devices to the correct port. Incorrect connection may result in malfunction and/or damage to the device and/or projector. Refer to the section "TECHNICAL" of this manual for the pin assignment of connectors and RS-232C communication data.

- Some cables have to be used with core set. Use the accessory cable or a designated-type cable for the connection. For cables that have a core only at one end, connect the core to the projector.
- Secure the screws on the connectors and tighten.
- Whenever attempting to connect a laptop computer to the projector, be sure to activate the laptop's RGB external image output (set the laptop to CRT display or to simultaneous LCD and CRT display). For details on how this is done, please refer to the instruction manual of the corresponding laptop computer.

#### **NOTE** About Plug-and-Play Capability

- This projector is compatible with VESA DDC 1/2B. Plug-and-Play can be achieved by connecting this projector to computers that are VESA DDC (display data channel) compatible. Please take advantage of this function by connecting the accessory RGB cable to the RGB port (DDC 1/2B compatible). Plug-and-Play may not work properly if any other type of connection is attempted.
- Plug-and-Play is a system composed of the computer, its operating system and peripheral equipment (i.e. display devices).
- Please use the standard drivers in your computer as this projector is a Plug-and-Play monitor.

#### **NOTE** • Some computers may have multiple display screen modes. Use of some of these modes will not be possible with this projector.

- For some RGB input modes, the optional Mac adapter is necessary.
- When the image resolution is changed on a computer, depending on an input, automatic adjust function may take some time and may not be completed. In this case, you may not be able to see a check box to select "Yes/No" for the new resolution on Windows. Then the resolution will go back to the original. It might be recommended to use other CRT or TFT monitors to change the resolution.

## Setting Up (continued)

Please refer to the following for connecting your devices.  
See the rear of the projector. You can see the ports.

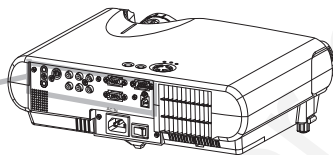

### Connecting to a computer

- RGB out ← RGB cable (D-sub 15 pin) → ①
- Audio out ← Audio cable (Stereo mini) → ②
- RS-232C port ← RS-232C cable → ③
- USB out ← USB cable → ④

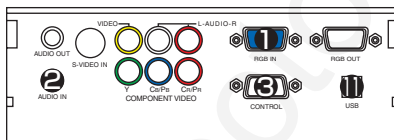

### Connecting to a DVD/VCR player

- Video out ← [ ] → ④
- Audio out (L) ← [ ] → ⑤
- Audio out (R) ← [ ] → ⑥

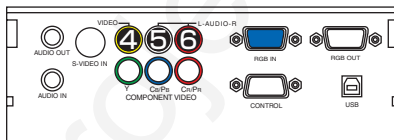

### If using a SCART RGB input,

- Video → [ ] → ④
- AUDIO-L → [ ] → ⑤
- AUDIO-R → [ ] → ⑥
- G → [ ] → ⑦
- B → [ ] → ⑧
- R → [ ] → ⑨

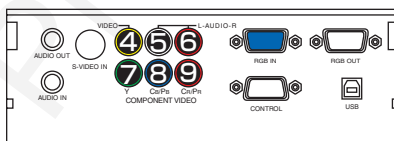

### If using a S-video input,

- S-video out port ← S-video cable → ⑩
- Audio out (L) ← [ ] → ⑤
- Audio out (R) ← [ ] → ⑥

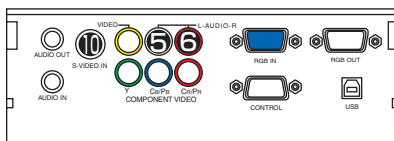

### If using a component input,

- Component (Y) out ← [ ] → ⑦
- Component (Cb/Pb) out ← [ ] → ⑧
- Component (Cr/Pr) out ← [ ] → ⑨
- Audio out (L) ← [ ] → ⑤
- Audio out (R) ← [ ] → ⑥

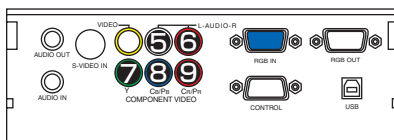

### If using a component input from RGB port,

- Component (Y) out ← [ ] → ①
- Component (Cb/Pb) out ← [ ] → ②
- Component (Cr/Pr) out ← [ ] (with D-sub 15 pin)
- Audio out ← Audio cable (Stereo mini) → ③

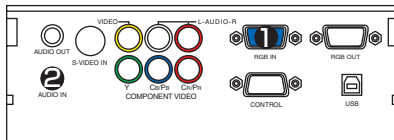

### If using a RGB output, a Audio output,

- RGB in ← RGB cable (D-sub 15 pin) → ⑫
- Audio in ← Audio cable (Stereo mini) → ⑬

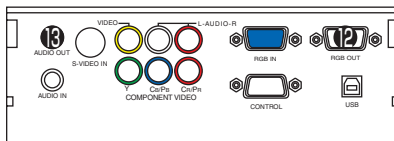

## Setting Up (continued)

### Connecting Power Supply

**⚠ WARNING** • Please use extra caution when connecting the power cord as incorrect or faulty connections may result in FIRE and/or ELECTRICAL SHOCK. Please adhere to the “User’s manual – Safety Guide” and the following.

- Only plug the power cord into outlets rated for use with the power cord’s specified voltage range.
- Only use the power cord that came with the projector. If it is damaged, contact your dealer to newly get correct one.
- Never modify the power cord. Never attempt to defeat the ground connection of the three-pronged plug.
- Make sure that you firmly connect the power cord to the projector and wall outlet.

**1** Connect the connector of the power cord to the AC inlet of the projector. ①

**2** Firmly plug the power cord’s plug into the outlet.

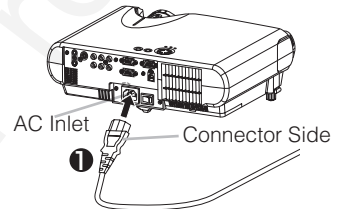

# Remote Control

## Putting Batteries

**⚠ CAUTION** Always handle the batteries with care and use them only as directed. Improper use may result in battery cracking or leakage, which could result in fire, injury and/or pollution of the surrounding environment.

- Keep the battery away from children and pets.
- Be sure to use only the batteries specified for use with the remote control. Do not mix new batteries with used ones.
- When inserting batteries, verify that the plus and minus terminals are aligned correctly (as indicated in the remote control).
- When you dispose the battery, you should obey the law in the relative area or country.

### 1 Remove the battery cover.

Slide back and remove the battery cover in the direction of the arrow.

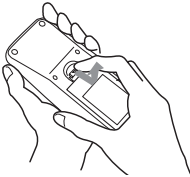

### 2 Insert the batteries.

Align and insert the two AA batteries according to their plus and minus terminals (as indicated in the remote control).

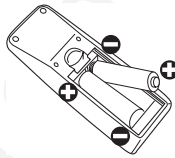

### 3 Close the battery cover.

Replace the battery cover in the direction of the arrow and snap it back into place.

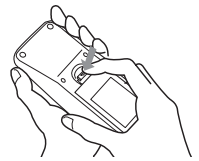

## Remote Control (continued)

### **Operating The Remote Control**

**ATTENTION** • Do not drop or otherwise expose the remote control to physical impact.

- Do not get the remote control wet or place it on wet objects. Doing so may result in malfunction.
- Remove the batteries from the remote control and store them in a safe place if you won't be using the remote control for an extended period.
- Replace the batteries whenever the remote control starts to malfunction.
- When strong lights, such as direct sunlight or light from an extremely close range (such as from an inverter fluorescent lamp), hit the projector's remote sensor, the remote control may cause to function. Adjust the direction of the projector to keep light from directly hitting the projector's remote sensor.

- The remote control works with the projector's remote sensor.
- The range of the remote sensor is 3 meters with a 60-degree range (30 degrees to the left and right of the remote sensor).  
Also a remote signal reflected in the screen etc. may be available. If it is difficult to send a remote signal to the sensor directly, please try.
- Since the remote control uses infrared light to send signals to the projector (Class1 LED), be sure to use the remote control in an area free from obstacles that could block the remote control's output signal to the projector.

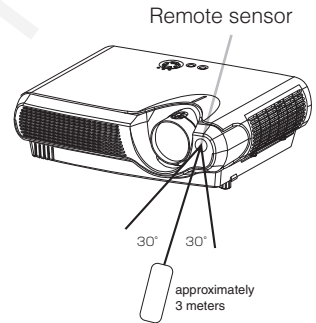

# Power ON/OFF

## Turning On The Power

**WARNING** • When the power is ON, a strong light is emitted. Do not look into the lens or vents of the projector.

**NOTE** • Turn the power on/off in right order. Please power on the projector before the connected devices. Power off the projector after the connected devices.

**1** Make sure that the power cord is firmly and correctly connected to the projector and outlet.

**2** When the lens cap is attached, remove the lens cap.

**3** Set the power switch to [ I ] (ON).



Power switch (ON position)

The POWER indicator will light orange.

**4** Press the **STANDBY/ON** button of the projector or the  button of the remote control.

The projector lamp will light up and the POWER indicator will begin blinking green.

According to a setup, the projector lamp may light up and the POWER indicator may begin blinking green, without pressing this button.

When the power is completely on, the indicator will stop blinking and light green.

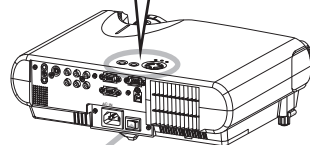
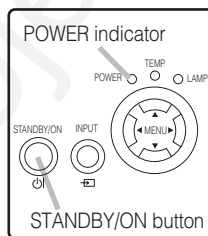

Power switch

 (STANDBY/ON) button

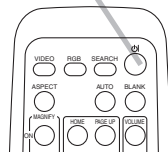

## Selecting An Input Signal

### 1 Using the projector's control button

#### Press the INPUT button.

As illustrated below, each time you press the INPUT button, the projector switches between its input signal ports. Select the signal you wish to project.

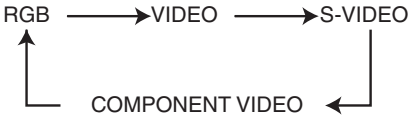

#### Selecting a RGB signal, using the remote control

#### Press the RGB button.

When this button is pressed, the projector switches to the RGB port.

#### Selecting a video signal, using the remote control

#### Press the VIDEO button.

As illustrated below, each time you press the VIDEO button, the projector switches between its input signal ports. Select the signal you wish to project.

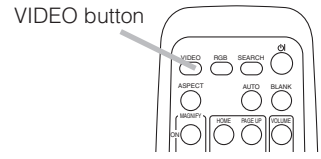
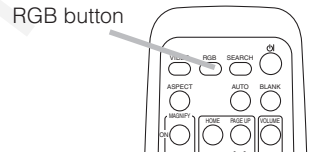
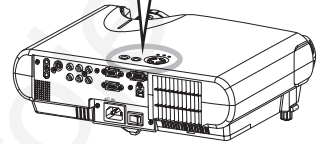
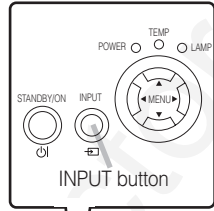
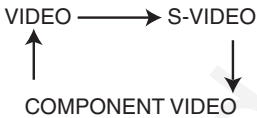

### 2 Use the zoom ring to adjust the screen size.

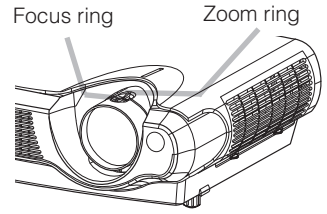

### 3 Use the focus ring to focus the picture.



## Power ON/OFF (continued)

### Turning Off The Power

**NOTE** • Turn the power on/off in right order. Please power on the projector before the connected devices. Power off the projector after the connected devices.

#### 1 Press the **STANDBY/ON** button of the projector or the button of the remote control.

The message “Power off?” will appear on the screen for approximately 5 seconds.

#### 2 Press the **STANDBY/ON** button again while “Power off?” the message is visible.

The projector lamp will go off, and the POWER indicator will begin blinking orange. Then the POWER indicator will stop blinking and light to solid orange when the lamp cooling is complete.

#### 3 Switch the power switch to **[O] (OFF)**.



Power switch (OFF position)

The POWER indicator will go off.

#### 4 Attached the lens cap.

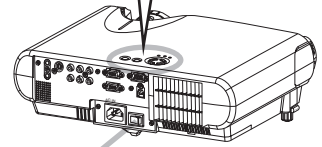
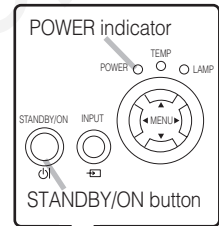

Power switch

 (STANDBY/ON) button

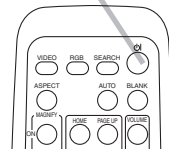

# Operating

## Adjusting The Volume

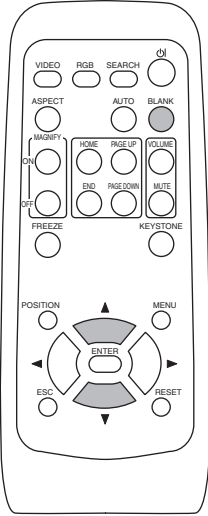

### 1 Press the **VOLUME** button.

As illustrated on the right, a dialog will appear on the screen to aid you in adjusting the volume.

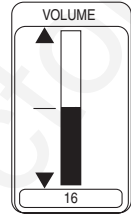

### 2 Use the **▲/▼** buttons to adjust the volume.

Press the VOLUME button again to close the dialog and complete this operation.

(Even if you don't do anything, the dialog will automatically disappear after a few seconds.)



- ▲ Press this to increase the volume
- ▼ Press this to decrease the volume

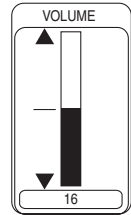

## Temporarily Muting The Sound

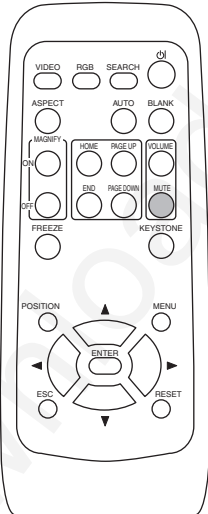

### 1 Press the **MUTE** button.

Press the MUTE button.

As illustrated on the right, a dialog will appear on the screen indicating that you have muted the sound.

(If you don't do anything, the dialog will automatically disappear after a few seconds.)

Press the MUTE or VOLUME button to restore the sound.

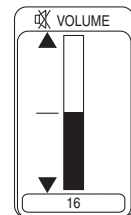

## Adjusting The Position

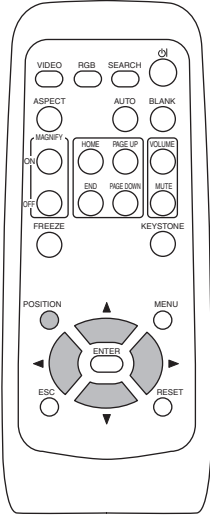

### 1 Press the **POSITION** button.

As illustrated on the right, a dialog will appear on the screen to aid you in adjusting the position.

POSITION



### 2 Use the **◀, ▶, ▲, ▼** buttons to adjust the position.

When you want to initialize the position, press the RESET button during adjustment.

Press the POSITION button again to close the dialog and complete this operation. (Even if you don't do anything, the dialog will automatically disappear after a few seconds.)

This function is only available for RGB input.

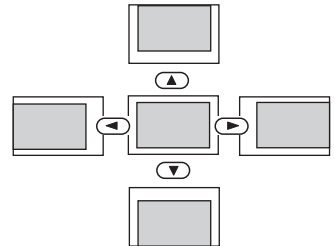

**NOTE** • When a menu is displayed, the operation of adjusting the position works for the position of not the picture but the menu.

## Operating (continued)

### Using The Automatic Adjustment Feature

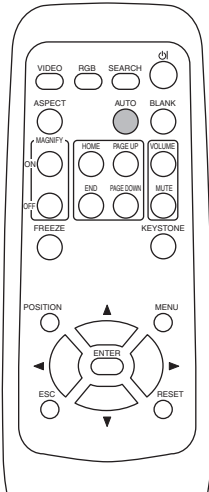

- 1 Press the **AUTO** button.



#### Automatic Adjustment for RGB Input

Horizontal position (H POSITION), vertical position (V POSITION), clock phase (H PHASE) and horizontal size (H SIZE) are automatically adjusted.

Make sure that the application window is set to its maximum size prior to attempting to use this feature. Dark pictures may still be incorrectly adjusted. Use a bright screen when adjusting.

#### Automatic Adjustment for Video Input

The signal type best suited for the respective input signal is selected automatically.

This feature is available only if VIDEO is set to AUTO in the INPUT menu.

**NOTE** • The automatic adjustment operation requires approximately 10 seconds. Also, please note that it may not function correctly with some input.

### Correcting Keystone Distortions

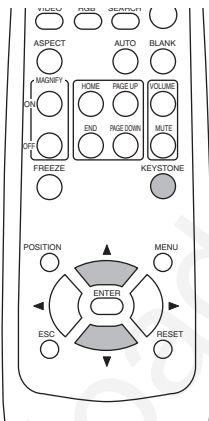

- 1 Press the **KEystone** button.

As illustrated on the right, a dialog will appear on the screen to aid you in correcting the distortion.

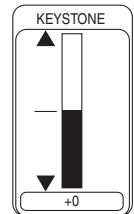

- 2 Use the **▲**, **▼** buttons to correct distortion.

Press the KEystone button again to close the dialog and complete this operation. (Even if you don't do anything, the dialog will automatically disappear after a few seconds.)



**NOTE** • When the WIDE is selected under the ASPECT item of the MAIN menu, this adjustment is ignored.

- The correcting keystone distortions function may not work well with some types of input signals.
- The adjustable range for correcting keystone distortions will vary with the type of input signal.

## Operating (continued)

### Using The Magnify Feature

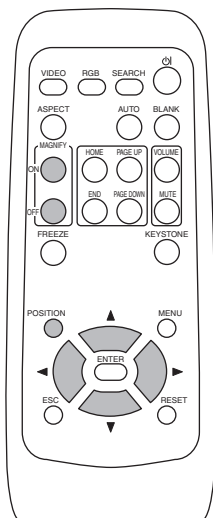

#### 1 Press the **MAGNIFY (ON)** button.

The projector enters MAGNIFY mode.



#### 2 Press the **POSITION** button, then use the **◀, ▶, ▲, ▼** buttons to select the area to zoom. Press the **POSITION** button again to finalize the zoom area.



#### 3 Use the **▲, ▼** buttons to adjust the zoom level.

Press the MAGNIFY (OFF) button to exit MAGNIFY mode and restore the screen to normal. (The projector will also automatically exit MAGNIFY mode if there is a change in the input signal's state.)



**NOTE** • The projector will automatically exit from MAGNIFY mode if either the SEARCH, RGB, AUTO, ASPECT or VIDEO feature is used, or, if there is a change in the input signal's state.

• The correcting keystone condition may vary when the magnify function is active. In this case, please make the magnify OFF, so the correcting keystone condition will be restored.

### Freezing The Screen

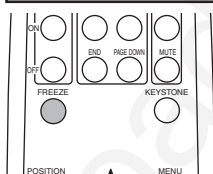

#### 1 Press the **FREEZE** button.

The [||] icon appears and the screen will freeze at the current image. Press the FREEZE button again and the [▶] appears as the projector exits FREEZE mode.



**NOTE** • The freezing function will automatically finish if either the STANDBY/ON, SEARCH, RGB, VIDEO, BLANK, AUTO, VOLUME, MUTE, POSITION or MENU button of remote control is pressed, or if a button of projector is pressed, or if there is a change in the input signal's state.

• If the projector continues projecting the same image for a long time (i.e. you forget to exit FREEZE mode), the image might possibly remain as an afterimage. Do not leave the projector in FREEZE mode for too long.

## Operating (continued)

### Signal Searching

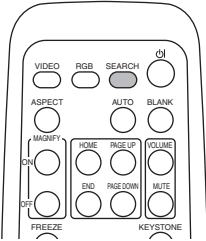

#### 1 Press the **SEARCH** button.

Cycle through input signals, displaying the images of retrieved signals. If no signal is found, returns to the signal that was selected before the search was begun.

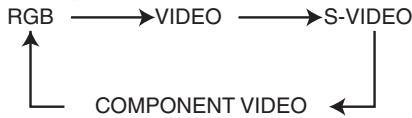

- NOTE**
- May not function properly with some input signals.
  - The signal searching function takes about 10 seconds to display an image.

### Selecting The Aspect Ratio

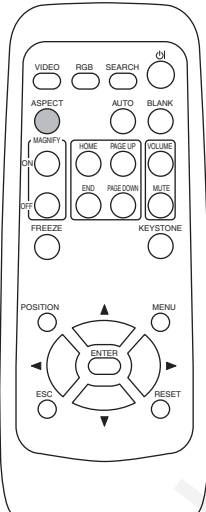

#### 1 Press the **ASPECT** button.

##### RGB input



- At a RGB input, selecting an aspect ratio may display the message "SYNC IS OUT OF RANGE". In this case, please select one of other aspect ratios.

##### VIDEO, S-VIDEO, COMPONENT VIDEO input

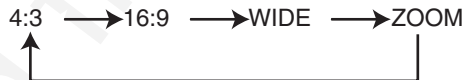

- At a COMPONENT VIDEO input of 16:9 Hi-Vision of 1125i (1035i/1080i)/750p, only 16:9 can be selected.
- When the 4:3 is selected under the SCREEN TYPE item of the OPTION menu. WIDE and ZOOM cannot be selected.

### Temporarily Blanking The Screen

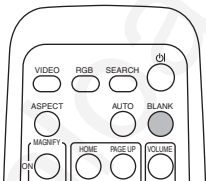

#### 1 Press the **BLANK** button.

The input signal screen is shut off, and a blank screen appears. You can set the blank screen using the menu (from the SCREEN menu, select BLANK).

Press the BLANK button again to remove the blank screen, and return to the input signal screen.



- NOTE**
- The temporarily blanking function will automatically finish if either the STANDBY/ON, SEARCH, RGB, VIDEO, FREEZE, AUTO, VOLUME, MUTE, POSITION or MENU button of remote control is pressed, or if a button of projector is pressed, or if there is a change in the input signal's state.

# Multifunctional Settings

## Using The Menu Functions

This projector has the following menus: MAIN, PICTURE-1, PICTURE-2, INPUT, AUTO, SCREEN, OPTION. Each of these menus is operated using the same methods. The basic operations of these menus are as follows.

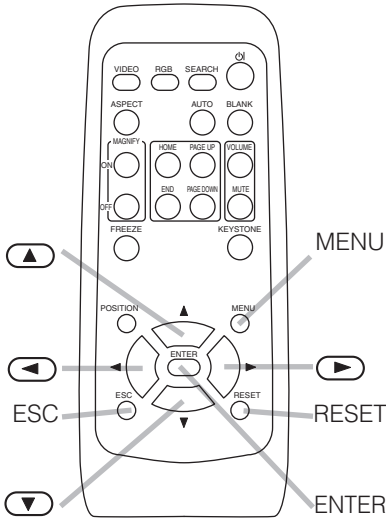

### 1 Press the MENU button.



The menu display appears on the screen.

### 2 Use the / buttons to select a menu, then press the or ENTER button.

The display of the selected menu appears.



#### [ex. Adjusting VOLUME]

1. Press the MENU button.

2. Use the / buttons to select the OPTION, then press the  or ENTER button.

### 3 Use the / buttons to select an item, then press the or ENTER button.



The operation display of the selected item appears.

3. Use the / buttons to select the VOLUME, then press the  or ENTER button.

### 4 Use the / buttons to operate the item.

When you want to reset the adjustment, press the RESET button during the operation. Note that the items whose functions are performed simultaneously with operating (ex. LANGUAGE, WHISPER, H PHASE etc.) are not reset.

When you want to return to the previous display, press the  or ESC button.

4. Use the / buttons to adjust the VOLUME.

### 5 Press the MENU button, or do not perform any operation for several seconds.

The menu display disappears and your operation finishes.

5. Press the MENU button.

# Multifunctional Settings (continued)

## MAIN Menu

With the MAIN menu, the items shown in the table below can be performed.

Perform each operation in accordance with the instructions in the table below.

MENU		▲
MAIN	KEystone	+0
PICTURE-1	BRIGHT	+0
PICTURE-2	CONTRAST	+0
INPUT	ASPECT	4:3
AUTO	WHISPER	NORMAL
SCREEN	MIRROR	NORMAL
OPTION	LANGUAGE	ENGLISH
	[Language]	
◀ SELECT ▶		▼

Item	Description
<b>KEystone</b>	<p><b>Adjust the Keystone (Vertical) Distortion:</b> Upper in the data (▲) ⇔ (▼) Lower in the data</p> <ul style="list-style-type: none"> <li>The adjustable range of this function will vary with the type of input signal. At some signals, this function may not work well.</li> <li>When the V:INVERT or the H&amp;V:INVERT is selected under the MIRROR item, if the projector screen is inclined or if the projector is angled downward, this function may not work correctly.</li> <li>When the WIDE is selected under the ASPECT item of the MAIN menu, this adjustment is ignored.</li> <li>When the zoom adjustment is set to the TELE side, this correction may be excessive. This function should be used with zoom set to WIDE whenever possible.</li> </ul>
<b>BRIGHT</b>	<b>Adjust Brightness:</b> Light (▲) ⇔ (▼) Dark
<b>CONTRAST</b>	<b>Adjust Contrast:</b> Strong (▲) ⇔ (▼) Weak
<b>ASPECT</b>	<p><b>Select an Aspect Ratio At a RGB input:</b> 4:3 (▲) ⇔ (▼) 16:9 (▲) ⇔ (▼) 15:9 (▲) ⇔ (▼) 32:15</p> <ul style="list-style-type: none"> <li>At a RGB input, selecting an aspect ratio may display the message "SYNC IS OUT OF RANGE". In this case, please select one of other aspect ratios.</li> </ul> <p><b>At a VIDEO input, a S-VIDEO input or a COMPONENT VIDEO input:</b> 4:3 (▲) ⇔ (▼) 16:9 (▲) ⇔ (▼) WIDE (▲) ⇔ (▼) ZOOM</p> <ul style="list-style-type: none"> <li>At a COMPONENT VIDEO input of 16:9 Hi-Vision of 1125i(1035i/1080i)/750p, only 16:9 can be selected.</li> <li>When the 4:3 is selected under the SCREEN TYPE item of the OPTION menu, WIDE and ZOOM cannot be selected.</li> </ul>
<b>WHISPER</b>	<p><b>Select the Whisper Mode:</b> NORMAL (▲) ⇔ (▼) WHISPER</p> <ul style="list-style-type: none"> <li>When the WHISPER is selected, acoustic noise and screen brightness are reduced.</li> </ul>
<b>MIRROR</b>	<p><b>Select a Mirror Status:</b> NORMAL (▲) ⇔ (▼) H:INVERT (▲) ⇔ (▼) V:INVERT (▲) ⇔ (▼) H&amp;V:INVERT</p>
<b>LANGUAGE</b>	<p><b>Select a Menu Language:</b> ENGLISH (▲) ⇔ (▼) FRANÇAIS (▲) ⇔ (▼) DEUTSCH (▲) ⇔ (▼) ESPAÑOL (▲) ⇔ (▼) ITALIANO (▲) ⇔ (▼) NORSK (▲) ⇔ (▼) NEDERLANDS (▲) ⇔ (▼) 日本語 (▲) ⇔ (▼) PORTUGUÊS (▲) ⇔ (▼) 中文 (▲) ⇔ (▼) 한글 (▲) ⇔ (▼) SVENSKA (▲) ⇔ (▼) РУССКИЙ (▲) ⇔ (▼) SUOMI (▲) ⇔ (▼) POLSKI</p>
<b>RESET</b>	<p><b>Reset the MAIN Menu Items:</b> Selecting the EXECUTE performs this function. EXECUTE (▲) ⇔ CANCEL</p> <ul style="list-style-type: none"> <li>The items of the MAIN menu are collectively returned to the initial setting. Note that the items WHISPER and LANGUAGE are not reset.</li> </ul>



# Multifunctional Settings (continued)

## PICTURE - 1 Menu

With the PICTURE - 1 menu, the items shown in the Table below can be performed.

















Perform each operation in accordance with the instructions in the table below.

MENU	▲	
MAIN	GAMMA	NORMAL
PICTURE-1	COLOR BAL R	+0
PICTURE-2	COLOR BAL G	+0
INPUT	COLOR BAL B	+0
AUTO	SHARPNESS	+0
SCREEN	COLOR	+0
OPTION	TINT	+0
	MY MEMORY	SAVE1
(2):SELECT	▼	

Item	Description
GAMMA	<p><b>Select a Gamma Mode:</b>            NORMAL (▲) ⇄ (▼) CINEMA (▲) ⇄ (▼) DYNAMIC (▲) ⇄ (▼) <u>CUSTOM</u></p> <ul style="list-style-type: none"> <li>Selecting the COSTOM and then pressing the (▶) or the ENTER button calls the CUSTOM menu.</li> </ul> <p><b>CUSTOM Menu</b>            Selecting one from the following and then pressing the (▶) or the ENTER button performs each function.</p> <p>GAMMA (▲) ⇄ (▼) COLOR TEMP (▲) ⇄ (▼) R (▲) ⇄ (▼) G (▲) ⇄ (▼) B</p> <ul style="list-style-type: none"> <li>The R, G and B can be selected only when the USER is selected under the COLOR TEMP.</li> </ul>
	<p><b>CUSTOM</b>  <b>GAMMA</b></p> <p><b>Adjust the Gamma Data:</b>            Up (▲) ⇄ (▼) Down</p>
	<p><b>CUSTOM</b>  <b>COLOR TEMP</b></p> <p><b>Select a Color Temperature Mode:</b>            HIGH (▲) ⇄ (▼) MIDDLE (▲) ⇄ (▼) LOW (▲) ⇄ (▼) USER</p>
	<p><b>CUSTOM</b>  <b>R</b></p> <p><b>Adjust the Red Color Level for the USER mode of the COLOR TEMP:</b>            Strong (▲) ⇄ (▼) Weak</p>
	<p><b>CUSTOM</b>  <b>G</b></p> <p><b>Adjust the Green Color Level for the USER mode of the COLOR TEMP:</b>            Strong (▲) ⇄ (▼) Weak</p>
	<p><b>CUSTOM</b>  <b>B</b></p> <p><b>Adjust the Blue Color Level for the USER mode of the COLOR TEMP:</b>            Strong (▲) ⇄ (▼) Weak</p>
COLOR BAL R	<b>Adjust the Red Color Balance:</b> Strong (▲) ⇄ (▼) Weak
COLOR BAL G	<b>Adjust the Green Color Balance:</b> Strong (▲) ⇄ (▼) Weak
COLOR BAL B	<b>Adjust the Blue Color Balance:</b> Strong (▲) ⇄ (▼) Weak
SHARPNESS	<p><b>Adjust the Whole Sharpness:</b> Clear (▲) ⇄ (▼) Soft</p> <ul style="list-style-type: none"> <li>This is a function for video inputs. This item can't be selected only at RGB inputs.</li> </ul>
COLOR	<p><b>Adjust COLOR :</b> Strong (▲) ⇄ (▼) Weak</p> <ul style="list-style-type: none"> <li>This is a function for video inputs. This item can't be selected only at RGB inputs including SCART RGB inputs.</li> <li>It is unavailable to deepen colors on SECAM signal input. (The adjustment bar position and value in menu box are changeable but no effect.)</li> </ul>
TINT	<p><b>Adjust the Tint:</b> Green (▲) ⇄ (▼) Red</p> <ul style="list-style-type: none"> <li>This is a function for video inputs. This item can't be selected only at RGB inputs including SCART RGB inputs.</li> </ul>

## Multifunctional Settings (continued)

### PICTURE - 1 Menu (continued)

Item	Description
<b>MY MEMORY</b>	<p><b>Load/Save a Setting:</b>            Selecting one from the following and then pressing the  or the ENTER button performs each function.</p> <p>LOAD1  ⇌  LOAD2  ⇌  LOAD3  ⇌  LOAD4  ⇌             ⇒  SAVE1  ⇌  SAVE2  ⇌  SAVE3  ⇌  SAVE4</p> <ul style="list-style-type: none"> <li>• This projector has 4 memories called M1, M2, M3 and M4 for settings. Performing the SAVE1, SAVE2, SAVE3 or SAVE4 puts the current setting data on the memory whose number corresponds. Performing the LOAD1, LOAD2, LOAD3 or LOAD4 calls the data of memory whose number corresponds, and adjusts the picture automatically depending on the data.</li> <li>• The LOAD1, LOAD2, LOAD3 or LOAD4 cannot be selected when there is no memory whose number corresponds.</li> <li>• At a different signal input from the signal that was being inputted when the setting was memorized, the picture may not be adjusted correctly.</li> </ul>
<b>RESET</b>	<p><b>Reset the PICTURE-1 Menu Items:</b>            Selecting the EXECUTE performs this function.</p> <p>EXECUTE  ⇌ CANCEL</p> <ul style="list-style-type: none"> <li>• The items of the PICTURE-1 menu are collectively returned to the initial setting. Note that the items MY MEMORY and CUSTOM - GAMMA are not reset.</li> </ul>

## Multifunctional Settings (continued)

### PICTURE - 2 Menu

With the PICTURE - 2 menu, the items shown in the table below can be performed.

Perform each operation in accordance with the instructions in the table below.

MENU		
MAIN	V POSITION	20
PICTURE-1	H POSITION	142
PICTURE-2	H PHASE	31
INPUT	H SIZE	1344
AUTO	OVER SCAN	95
SCREEN	RESET	
OPTION		
[OK]: SELECT		

Item	Description
<b>V POSITION</b>	<p><b>Adjust the Vertical Position:</b> Up  ⇌  Down</p> <ul style="list-style-type: none"> <li>This item can be selected only at a RGB input.</li> </ul>
<b>H POSITION</b>	<p><b>Adjust the Horizontal Position:</b> Left  ⇌  Right</p> <ul style="list-style-type: none"> <li>This item can be selected only at a RGB input.</li> </ul>
<b>H PHASE</b>	<p><b>Adjust the Horizontal Phase (to eliminate flicker) :</b> Right  ⇌  Left</p> <ul style="list-style-type: none"> <li>This item can be selected only at a RGB input or a COMPONENT VIDEO input.</li> </ul>
<b>H SIZE</b>	<p><b>Adjust the Horizontal Size:</b> Large  ⇌  Small</p> <ul style="list-style-type: none"> <li>When this adjustment is excessive, the picture may not be displayed correctly. In such a case, please press the RESET button during selection of this item to reset the H SIZE.</li> <li>This item can be selected only at a RGB input.</li> </ul>
<b>OVER SCAN</b>	<p><b>Adjust the Over-scan Ratio:</b> Large  ⇌  Small</p> <ul style="list-style-type: none"> <li>This item can be selected only at a VIDEO input, a S-VIDEO input or a COMPONENT VIDEO input.</li> <li>When this adjustment is too large, a certain degradation may appear at the frame area of the picture. In such a case, please adjust small.</li> </ul>
<b>RESET</b>	<p><b>Reset the PICTURE-2 Menu Items:</b> Selecting the EXECUTE performs this function. EXECUTE  ⇌ CANCEL</p> <ul style="list-style-type: none"> <li>The items of the PICTURE-2 menu are collectively returned to the initial setting. Note that the H PHASE item is not reset.</li> </ul>

# Multifunctional Settings (continued)

## INPUT Menu

With the INPUT menu, the items shown in the table below can be performed.

Perform each operation in accordance with the instructions in the table below.

MENU	▲	
MAIN	COLOR SPACE	AUTO
PICTURE-1	COMPONENT	COMPONENT
PICTURE-2	VIDEO	AUTO
INPUT	FRAME LOCK	TURN ON
AUTO	3D-YCS	NORMAL
SCREEN	VIDEO NR	LOW
OPTION	PROGRESSIVE	TURN OFF
	INFORMATION	
(C):SELECT	▼	

Item	Description
<b>COLOR SPACE</b>	<p><b>Select a Color Space Mode:</b>            AUTO (▲) ⇄ (▼) RGB (▲) ⇄ (▼) SMPTE240 (▲) ⇄ (▼) REC709 (▲) ⇄ (▼) REC601</p> <ul style="list-style-type: none"> <li>This item can be selected only at a RGB input or a COMPONENT VIDEO input.</li> <li>When the AUTO is selected, the optimum mode is automatically selected. However, it may not work well at some signals. In such a case, select the SMPTE240 or REC709 for HDTV signal.</li> </ul>
<b>COMPONENT</b>	<p><b>Select a Function of COMPONENT VIDEO Jacks:</b>            COMPONENT (▲) ⇄ (▼) SCART RGB</p> <ul style="list-style-type: none"> <li>When the SCART RGB is selected, the COMPONENT VIDEO jacks function as ports for a RGB input with a SCART cable. Refer to the section "Signal Connectors" of "TECHNICAL".</li> </ul>
<b>VIDEO</b>	<p><b>Select a Signal Type Mode:</b>            AUTO (▲) ⇄ (▼) NTSC (▲) ⇄ (▼) PAL (▲) ⇄ (▼) SECAM (▲) ⇄ (▼) NTSC 4.43 (▲) ⇄ (▼) M-PAL (▲) ⇄ (▼) N-PAL</p> <ul style="list-style-type: none"> <li>This item performs only at a VIDEO input or a S-VIDEO input. For a COMPONENT VIDEO input, although this item is ineffective, the signal type is identified automatically even if the AUTO is not selected.</li> <li>Selecting the AUTO automatically selects the optimum mode. However, it may not work well at a PAL60 signal and some other signals. If the picture becomes unstable (ex. a irregular picture, color lack), please select the mode depending on the input signal.</li> <li>The AUTO operation requires approximately 10 seconds.</li> </ul>
<b>FRAME LOCK</b>	<p><b>Select the Frame Lock Mode:</b>            TURN ON (▲) ⇄ (▼) TURN OFF</p> <ul style="list-style-type: none"> <li>This function performs only at a RGB input with vertical frequency of 48 to 72 Hz.</li> <li>When the TURN ON is selected, a moving picture is displayed more smoothly.</li> <li>This function may cause a certain degradation of the picture. In such a case, please select the TURN OFF.</li> </ul>
<b>3D-YCS</b>	<p><b>Select a 3D-YCS mode:</b>            STILL IMAGE (▲) ⇄ (▼) NORMAL (▲) ⇄ (▼) TURN OFF</p> <ul style="list-style-type: none"> <li>This function performs only at a VIDEO input of NTSC 3.58.</li> <li>NORMAL is the mode for images with a lot of motions like movies, and STILL IMAGE is the mode for images with few motions or completely still ones like slides.</li> <li>When this function performs, the VIDEO NR function is ineffective.</li> </ul>

## Multifunctional Settings (continued)

### INPUT Menu (continued)

Item	Description
VIDEO NR	<p><b>Select a Noise Reduction Mode:</b>            HIGH (▲) ⇄ (▼) MIDDLE (▲) ⇄ (▼) LOW</p> <ul style="list-style-type: none"> <li>• This function performs only at a VIDEO input or a S-VIDEO input. At a VIDEO input of NTSC 3.58, this function performs only when the TURN OFF is selected under the 3D-YCS.</li> <li>• When the HIGH, the MIDDLE or the LOW is selected, the noise on screen is reduced according to each mode.</li> <li>• When this function is excessive, it may cause a certain degradation of the picture.</li> </ul>
PROGRESSIVE	<p><b>Select the Progressive Mode:</b>            TV (▲) ⇄ (▼) FILM (▲) ⇄ (▼) TURN OFF</p> <ul style="list-style-type: none"> <li>• This function performs only at an interlaced signal of a VIDEO input, a S-VIDEO input or a COMPONENT VIDEO input of 525i or 625i signal. The FILM mode is adaptable to the 3-2 Pull-Down system to the conversion.</li> <li>• When the TV or FILM is selected, the screen image will be crisper. But it may cause a certain defect (for example, jagged line) of the picture at a quick moving object. In such a case, please select the TURN OFF, even though the screen image may lose the crisp.</li> <li>• This function may cause a certain degradation of the picture. In such a case, please select the TURN OFF.</li> </ul>
INFORMATION	<p><b>Display the Information:</b>            Pressing the (▶) or the ENTER button performs this function.</p> <ul style="list-style-type: none"> <li>• Use this function when you want the information about the current input (ex. the resolution and the vertical frequency at a RGB input, the signal type of a video input) and setting states of the COMPONENT, the VIDEO and the FLAME LOCK.</li> </ul>
S2-ASPECT	<p><b>Select the S2-ASPECT Mode:</b>            TURN ON (▲) ⇄ (▼) TURN OFF</p> <ul style="list-style-type: none"> <li>• This function performs only at a S-VIDEO input.</li> <li>• When the TURN ON is selected, an S2-Video signal can be identified and the optimum aspect ratio is automatically selected.</li> <li>• When the ASPECT button of the remote control is used or the ASPECT item of the MAIN menu is operated, the S2-ASPECT mode will be switched to the TURN OFF automatically.</li> </ul>
RESET	<p><b>Reset the INPUT Menu Items:</b>            Selecting the EXECUTE performs this function.            EXECUTE (▲) ⇄ CANCEL</p> <ul style="list-style-type: none"> <li>• The items of the INPUT menu are collectively returned to the initial setting. Note that the INFORMATION item is not reset.</li> </ul>

# Multifunctional Settings (continued)

## AUTO Menu

With the AUTO menu, the items shown in the table below can be performed.

Perform each operation in accordance with the instructions in the table below.

MENU	
MAIN	ADJUST
PICTURE-1	POWER OFF 0 min
PICTURE-2	SEARCH
INPUT	RESET
AUTO	
SCREEN	
OPTION	
[OK] SELECT	

Item	Description
ADJUST	<p><b>Automatically Adjust the Picture:</b> Pressing the  or the ENTER button performs this function.</p> <p><b>At a RGB input:</b></p> <ul style="list-style-type: none"> <li>• V POSITION, H POSITION, H PHASE and HSIZE are automatically adjusted. Please use this function with the maximum window size.</li> </ul> <p><b>At a VIDEO input or S-VIDEO input:</b></p> <ul style="list-style-type: none"> <li>• This function performs only when the AUTO is selected under the VIDEO item of the INPUT menu. For a COMPONENT VIDEO input, although this function is ineffective, the signal type is identified automatically even if the AUTO is not selected.</li> <li>• This function automatically selects the optimum mode for the input signal. However, it may not work well at a PAL60 signal and some other signals. If the picture becomes unstable (ex. irregular picture, color lack), please use the function of VIDEO of the INPUT menu.</li> <li>• The operation of this function requires approximately 10 seconds. Also, please note that it may not function correctly with some input.</li> </ul>
POWER OFF	<p><b>Set the Automatically Power Off Timer:</b> Long (Max. 99 minutes.)  ⇄  Short (Min. 0 minute =DISABLE)</p> <ul style="list-style-type: none"> <li>• This function performs only when the time is set to 1 to 99.</li> <li>• When the set time passes without a valid signal (there is no signal, or the signal is out of specifications), the projector lamp automatically goes off, and the POWER indicator begins blinking. Please refer to the section "Turning Off The Power" of "Power ON/OFF" about the turning off.</li> </ul>
SEARCH	<p><b>Automatically Signal Search:</b> TURN ON  ⇄  TURN OFF</p> <ul style="list-style-type: none"> <li>• If the TURN ON is selected under this item when no signal input is detected, the projector begins searching for an input signal. When an input signal is detected the projector will cease searching and the picture will appear.</li> <li>• The priority of a search is as follows: RGB → VIDEO → S-VIDEO → COMPONENT VIDEO </li> <li>• If the projector is unstable to find an input signal at any of its ports, it will return to the state it was in prior to the search.</li> </ul>
RESET	<p><b>Reset the AUTO Menu Items:</b> Selecting the EXECUTE performs this function. EXECUTE  ⇄ CANCEL</p> <ul style="list-style-type: none"> <li>• The items of the AUTO menu are collectively returned to the initial setting. Note that the item ADJUST is not reset.</li> </ul>

## Multifunctional Settings (continued)

### SCREEN Menu

With the SCREEN menu, the items shown in the table below can be performed.

Perform each operation in accordance with the instructions in the table below.

MENU		
MAIN	BLANK	BLACK
PICTURE-1	START UP	TURN ON
PICTURE-2	MENU POSITION	TURN ON
INPUT	MESSAGE	TURN ON
AUTO	RESET	
SCREEN		
OPTION		
[SELECT]		

Item	Description
<b>BLANK</b>	<p><b>Select a Blank Screen Color:</b>            BLUE (▲) ⇄ (▼) WHITE (▲) ⇄ (▼) BLACK</p> <ul style="list-style-type: none"> <li>The blank screen of selected color is displayed by pressing the BLANK button. Please refer to the section "Temporarily Blanking The Screen" of "Operating" about the screen blanking.</li> </ul>
<b>START UP</b>	<p><b>Select the Start Up Screen:</b>            TURN ON (▲) ⇄ (▼) TURN OFF</p> <ul style="list-style-type: none"> <li>If the TURN ON is selected when there is no signal or the detected signal is out of specifications, the blank screen is displayed.</li> </ul>
<b>MENU POSITION</b>	<p><b>Adjust a Menu Position:</b>            Pressing the (▶) or ENTER button start adjusting,</p> <div style="text-align: center;">             Up              (▲)              ↑              Left (◀) ↔ (▶) Right              ↓              (▼)              Down           </div> <ul style="list-style-type: none"> <li>The (◀) button does not finish this item. When you want to return to the previous display, please press the ESC button.</li> </ul>
<b>MESSAGE</b>	<p><b>Select the Message Mode:</b>            TURN ON (▲) ⇄ (▼) TURN OFF</p> <ul style="list-style-type: none"> <li>When the TURN OFF is selected, the following message functions are disabled:              The message of "AUTO IN PROGRESS"              The message of "NO INPUT IS DETECTED"              The message of "SYNC IS OUT OF RANGE"              The message while being searched for an input signal, "Searching ....."              The message when an input signal is detected, "Detecting ....."              The indication of the input signal by input change.</li> </ul>
<b>RESET</b>	<p><b>Reset the SCREEN Menu Items:</b>            Selecting the EXECUTE performs this function.            EXECUTE (▲) ⇄ CANCEL</p> <ul style="list-style-type: none"> <li>The items of the SCREEN menu are collectively returned to the initial setting.</li> </ul>

# Multifunctional Settings (continued)

## OPTION Menu

With the OPTION menu, the items shown in the table below can be performed. Perform each operation in accordance with the instructions in the table below.

MENU	
MAIN	VOLUME 16
PICTURE-1	SCREEN TYPE 4:3 <input type="checkbox"/>
PICTURE-2	LAMP TIME 1234h
INPUT	FILTER TIME 21h
AUTO	RESET
SCREEN	
OPTION	
[3] SELECT	

Item	Description
<b>VOLUME</b>	<b>Adjust Volume:</b> High  ⇌  Low
<b>SCREEN TYPE</b>	<p><b>Select the Screen Type:</b>            4:3   ⇌  16:9   ⇌  16:9   ⇌  16-9 </p> <ul style="list-style-type: none"> <li>Please select the screen type used and the picture position in case of 16:9. This selection is used as basic information for a suitable display. This function should be performed before other picture adjustment.</li> </ul>
<b>LAMP TIME</b>	<p>To begin the operation of this item, please press the  button of the projector or the RESET button of the remote control for 3 seconds.</p> <p><b>Reset the Lamp Timer:</b>            Selecting the RESET performs this function.            RESET  ⇌ CANCEL</p> <ul style="list-style-type: none"> <li>The numerical value of four digits shown on this menu is the projector use time since the last RESET operation of this item. The value is reset to 0 at the same time the RESET is selected.</li> <li>The value of this function is used to display the message of "CHANGE THE LAMP". So this function must be performed only immediately after replacing the lamp.</li> </ul> <p>Do not perform this function unless you have replaced the lamp. Perform this function every time the lamp is replaced. Incorrect performing of this function causes incorrect operation of the message function.</p> <ul style="list-style-type: none"> <li>Please see to the section "Lamp" about replacing the lamp.</li> </ul>
<b>FILTER TIME</b>	<p>To begin the operation of this item, please press the  button of the projector or the RESET button of the remote control for 3 seconds.</p> <p><b>Reset the Filter Timer:</b>            Selecting the RESET performs this function.            RESET  ⇌ CANCEL</p> <ul style="list-style-type: none"> <li>The numerical value of four digits shown on this menu is the projector use time since the last RESET operation of this item. The value is reset to 0 at the same time the RESET is selected.</li> <li>The value of this function is used to display the message of "CLEAN THE AIR FILTER". So this function must be performed only immediately after cleaning or replacing the air filter.</li> </ul> <p>Do not perform this function unless you have cleaned or replaced the air filter. Perform this function every time the air filter is cleaned or replaced. Incorrect performing of this function causes incorrect operation of the message function.</p> <ul style="list-style-type: none"> <li>Please see to the section "Air Filter" about cleaning and replacing the air filter.</li> </ul>
<b>RESET</b>	<p><b>Reset the OPTION Menu Items:</b>            Selecting the EXECUTE performs this function.            EXECUTE  ⇌ CANCEL</p> <ul style="list-style-type: none"> <li>The SCREEN TYPE item is returned to the initial setting. Note that the items VOLUME, LAMP TIME and FILTER TIME are not reset.</li> </ul>



# Operating The PC Screen

You can use the remote control as a simplified mouse or keyboard.

**CAUTION** Mistaken use of the mouse/keyboard control could damage your equipment.

- Only connect to a PC.
- Before connecting, read the manuals of the device you will connect.
- Do not unplug the connector cables while the computer is operating.

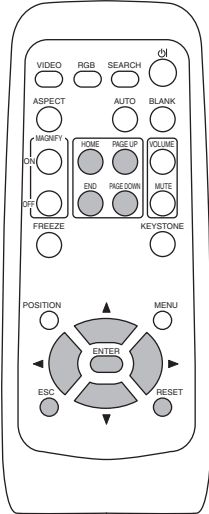

## USB Mouse/Keyboard Control

1. Connect the projector's USB terminal to the computer using a USB cable. The functions in the table below can be controlled.

Available Functions	Remote Control Operation
Move Pointer	Use     buttons
Left click with mouse	Press ENTER button
Right click with mouse	Press RESET button
Press keyboard's HOME key	Press HOME button
Press keyboard's END key	Press END button
Press keyboard's PAGE UP key	Press PAGE UP button
Press keyboard's PAGE DOWN key	Press PAGE DOWN button
Press keyboard's ESC key	Press ESC button

## NOTES

- It may not be possible to control notebook PCs, and other computers with built-in pointing devices (e.g. track balls), using this remote control. In this case, before connecting go into BIOS (system setup) and select external mouse, and disable the pointing devices. In addition, the mouse may not function if the computer does not have the needed utility program. See your computer's hardware manual for details.
- The USB control can be used with Windows 95 OSR 2.1 or higher. It may not be possible to use the remote control, depending on the computer's configurations and mouse drivers.
- The USB control can only be used for the functions listed above. You cannot do things like press two buttons at once (for instance, pressing two buttons at the same time to move the mouse pointer diagonally).
- This function is not available while the lamp is warming up (the POWER indicator flashes green), while adjusting the volume and display, correcting for trapezoidal distortion, zooming in on the screen, using the BLANK function, or displaying the menu screen.

# Lamp



## WARNING



HIGH VOLTAGE



HIGH TEMPERATURE



HIGH PRESSURE

The projector uses a high-pressure mercury glass lamp. The lamp can **break with a loud bang, or burn out**, if jolted or scratched, handled while hot, or worn over time. Note that each lamp has a different lifetime, and some may burst or burn out soon after you start using them. In addition, when the bulb bursts, it is possible for **shards of glass** to fly into the lamp housing, and for **gas containing mercury** to escape from the projector's vent holes.

**About disposal of a lamp** • This product contains a mercury lamp; do not put in trash. Dispose of in accord with environmental laws.

For lamp recycling, go to [www.lamprecycle.org](http://www.lamprecycle.org). (in USA)

For product disposal, contact your local government agency or [www.eiae.org](http://www.eiae.org) (in the US) or [www.epsc.ca](http://www.epsc.ca) (in Canada).

For more information, call your dealer.



Disconnect the plug from the power outlet

- If the lamp should break (it will make a loud bang when it does), unplug the power cord from the outlet, and make sure to request a replacement lamp from your local dealer. Note that shards of glass could damage the projector's internals, or cause injury during handling, so please do not try to clean the projector or replace the lamp yourself.
- If the lamp should break (it will make a loud bang when it does), ventilate the room well, and make sure not to breathe the gas that comes out of the projector vents, or get it in your eyes or mouth.
- Before replacing the lamp, make sure the power switch is off and the power cable is not plugged in, then wait at least 45 minutes for the lamp to cool sufficiently. Handling the lamp while hot can cause burns, as well as damaging the lamp.



- Do not open the lamp cover while the projector is suspended from above. This is dangerous, since if the lamp's bulb has broken, the shards will fall out when the cover is opened. In addition, working in high places is dangerous, so ask your local dealer to have the lamp replaced even if the bulb is not broken.
- Do not use the projector with the lamp cover removed. At the lamp replacing, make sure that the screws are screwed in firmly. Loose screws could result in damage or injury.



- Use only the lamp of the specified type **DT00621**.
- If the lamp breaks soon after the first time it is used, it is possible that there are electrical problems elsewhere besides the lamp. If this happens, contact your local dealer or a service representative.
- Handle with care: jolting or scratching could cause the lamp bulb to burst during use.
- If the indicators or a message prompts you to replace the lamp (see the section "Related Messages" and "Regarding the indicator Lamps"), replace the lamp as soon as possible. Using the lamp for long periods of time, or past the replacement date, could cause it to burst. Do not use old (used) lamps; this is a cause of breakage.

## Lamp (continued)

### Replacing The Lamp

- ⚠ **WARNING** • Please carefully read the “User’s Manual - Safety Guide”.
- ⚠ **CAUTION** • Do not reset the lamp timer without replacing the lamp.
  - When you replace the lamp, please replace also the air filter. The air filter may be attached when you buy a replacement lamp for this projector. Please ask your dealer.

If the indicators or a message prompts you to replace the lamp, replace the lamp as soon as possible. Using the lamp for long periods of time, or past the replacement date, could cause it to burst. If the projector is mounted on the ceiling, or if the lamp has broken, do not try to clean the projector or replace the lamp yourself.

- 1 Turn off the projector, and unplug the power cord. Allow the lamp bulb to cool for at least 45 minutes.**
- 2 Contact your local dealer to prepare a new lamp. Tell the dealer your lamp type number. If the projector is mounted on the ceiling, or if the lamp has broken, also ask the dealer to replace the lamp.**

In the case of replacement by yourself,

- 3 After making sure that the projector has cooled adequately, slowly flip over the projector, so that the bottom is facing up.**
- 4 Hold the release button while sliding and taking up the lamp cover.**
- 5 Unscrew the 2 screws, and slowly pick up the lamp by the handles.**
- 6 Insert the new lamp, and tighten the 2 screws firmly to lock it in place.**

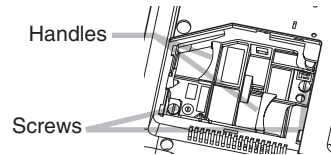
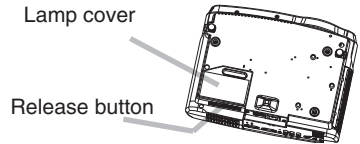

- 7 Slide the lamp cover into place until it locks into position.**
- 8 Slowly turn the projector so that the top is facing up.**
- 9 Turn on the projector, and reset the lamp timer. When the lamp has been replaced after the message of “THE POWER WILL TURN OFF AFTER 0hr.” is displayed, complete the following operation within 10 minutes of switching power on.**

- (1) While the projector running, press the MENU button to open the menu.
- (2) Choose the “OPTION” on the menu using the / button, then press the button or ENTER button.
- (3) Choose the “LAMP TIME” using the / button, then press and hold the button of projector or the RESET button of remote control for 3 seconds.
- (4) Choose the “RESET” using the button.

## Air Filter

### **⚠ WARNING** • Please carefully read the “User’s Manual - Safety Guide”.

• Before replacing the air filter, make sure the power switch is off and the power cable is not plugged in.

• Use the air filter of the specified type only. **Type number: NJ08292** (sold separately)

• Do not use the projector with the air filter and filter cover removed. The use without the air filter could result in damage.

### **⚠ CAUTION** • Do not reset the filter timer without cleaning or replacing the air filter.

• If the air filter becomes clogged by dust or the like, internal temperature rises and could cause malfunction. The power is automatically turned off in order to prevent the projector from overheating internally.

• When you replace the lamp, please replace also the air filter. The air filter may be attached when you buy a replacement lamp for this projector. Please ask your dealer.

## **Caring For The Air Filter**

The air filter should be cleaned about every 100 hours. If the indicators or a message prompts you to clean the air filter (see the section “Related Messages” and “Regarding The Indicator Lamps”), clean the air filter as soon as possible. If the air filter becomes clogged by dust or the like, internal temperature rises and could cause malfunction.

### **1 Turn off the projector, and unplug the power cord.**

### **2 Apply a vacuum cleaner to the top of the filter cover to clean the air filter.**

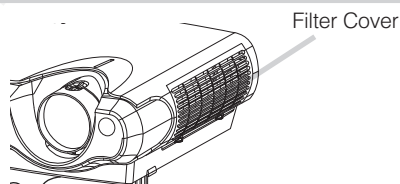

### **3 Reset the filter timer.**

(1) Turn on the projector. While the projector running, press the MENU button to open the menu.

(2) Choose the “OPTION” on the menu using the / button, then press the button or ENTER button.

(3) Choose the “FILTER TIME” using the / button, then press and hold the button of projector or the RESET button of remote control for 3 seconds.

(4) Choose the “RESET” using the button.

## Air Filter (continued)

### Replacing The Air Filter

If the soiling will not come off the air filter, or it becomes damaged, then it needs to be replaced. Please replace the air filter as soon as possible.

**1 Turn off the projector, and unplug the power cord.**

**2 Contact your local dealer to prepare a new air filter. Tell the dealer your air filter type number.**

**3 After making sure that the projector has cooled adequately, remove the filter cover. Hold the release buttons of the filter cover, while pulling up it.**

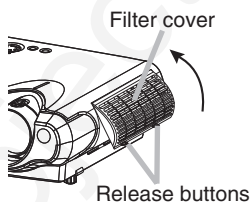



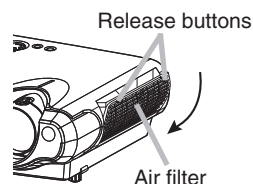



**4 Hold the release buttons of the air filter, while pulling down it.**



**5 Insert a new air filter, and replace the filter cover.**

**6 Reset the filter timer.**

- (1) Turn on the projector. While the projector running, press the MENU button to open the menu.
- (2) Choose the "OPTION" on the menu using the  /  button, then press the  button or ENTER button.
- (3) Choose the "FILTER TIME" using the  /  button, then press and hold the  button of projector or the RESET button of remote control for 3 seconds.
- (4) Choose the "RESET" using the  button.

## Other Care

**⚠ WARNING** • Please carefully read the “User’s Manual - Safety Guide”.

- Before replacing the air filter, make sure the power switch is off and the power cable is not plugged in.

**⚠ ATTENTION** • Do not use cleaners or chemicals other than those listed below, including benzene and paint thinner.

- Do not use aerosols or sprays.
- Do not polish or wipe with hard objects.

### **Caring For The Inside Of The Projector**

In order to ensure the safe use of your projector, please have it cleaned and inspected by your local dealer about once every 2 years. Never try to care for the inside of the unit yourself. Doing so is dangerous.

### **Caring For The Lens**

**1 Turn off the projector, and unplug the power cord.**

**2 Lightly wipe the lens with a commercially available lens-cleaning wipe. Do not touch the lens directly with your hand.**

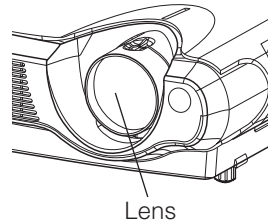

### **Caring For The Cabinet And Remote Control**

**1 Turn off the projector, and unplug the power cord.**

**2 Wipe lightly with gauze or a soft cloth.**

If soiling is severe, dip soft cloth in water or a neutral cleaner dilute in water, and wipe lightly after wringing well. Then, wipe lightly with a soft, dry cloth.

## Troubleshooting

### Related Messages

When the unit's power is ON, messages such as those shown below may be displayed. When any such message is displayed on the screen, please respond as described below. If the same message is displayed after the treatment, or if a message other than the following appears, please contact your dealer or service company.

Message	Description
<b>CHANGE THE LAMP AFTER REPLACING LAMP, RESET THE LAMP TIMER.</b> (*1)	Lamp usage time is approaching 2000 hours. (*2) Preparation of a new lamp, and an early lamp change is recommended. After you have changed the lamp, please be sure to reset the lamp timer.
<b>CHANGE THE LAMP AFTER REPLACING LAMP, RESET THE LAMP TIMER. THE POWER WILL TURN OFF AFTER ** hr.</b> (*1)	Lamp usage time is approaching 2000 hours. (*2) A lamp change within ** hours is recommended. When lamp usage reaches 2000 hours, the power will automatically be turned OFF. Please change the lamp by referring to the "Lamp" section of this manual. After you have changed the lamp, please be sure to reset the lamp timer.
<b>CHANGE THE LAMP AFTER REPLACING LAMP, RESET THE LAMP TIMER. THE POWER WILL TURN OFF AFTER 0 hr.</b>	As lamp use has reached 2000 hours (*2), the power will soon be automatically turned OFF. Please immediately turn the power off, and change the lamp by referring to the "Lamp" section of this manual. After you have changed the lamp, please be sure to reset the lamp timer.
<b>NO INPUT IS DETECTED ON ***</b>	There is no input signal. Please confirm the signal input connection, and the status of the signal source.
<b>SYNC IS OUT OF RANGE ON *** fH *****kHz fV *****Hz</b>	The horizontal or vertical wavelength of the inputted signal is outside of the response parameters of this unit. Please confirm the specs for this unit or the signal source specs.
<b>CHECK THE AIR FLOW</b>	The internal portion temperature is rising. Please turn the power OFF, and allow the unit to cool down at least 20 minutes. After having confirmed the following items, please turn the power ON again. <ul style="list-style-type: none"> <li>• Is there blockage of the air passage aperture?</li> <li>• Is the air filter dirty?</li> <li>• Does the peripheral temperature exceed 35°C?</li> </ul>

**NOTE** (\*1) • Although this message will be automatically disappeared after around 3 minutes, it will be reappeared every time the power is turned ON.

(\*2) • Lamps have a finite product life. Lamps are characterized by the fact that, after long hours of usage, a lamp will no longer light up, or the lamp will break or burst, etc. This unit is equipped with an automatic shut-down function, such that the power will automatically be turned OFF when lamp usage time has reached 2,000 hours. Please be aware, however, that among lamp types, there are major differences in product lifetimes; a lamp may thus fail to light even prior to the functioning of the automatic shut-down function of this unit.

## Troubleshooting (continued)

### Related Messages (continued)

Message	Description
<b>CLEAN THE AIR FILTER POWER OFF FIRST, THEN CLEAN THE AIR FILTER. AFTER CLEANING THE AIR FILTER, RESET THE FILTER TIMER.</b>	A note of precaution when cleaning the air filter. Please immediately turn the power OFF, and clean or change the air filter by referring to the "Air Filter" section of this manual. After you have cleaned or changed the air filter, please be sure to reset the filter timer. If the same message is displayed after the treatment, please clean the transparent area of filter cover and the dust-detecting window, according to the following.

**ATTENTION** • The transparent area of filter cover and the dust-detecting window should be cleaned for normal operation of the optical dust detecting system. Please pay attention not to remain fiber or fragment of cloth inside the duct.

**1 Turn off the projector, and unplug the power cord.**

**2 After making sure that the projector has cooled adequately, remove the filter cover.**

Hold the release buttons of the filter cover, while pulling up it.

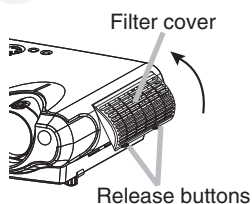

**3 Wipe the transparent area of the filter cover by using a swab or a soft cloth.**

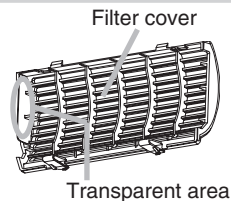

**4 Remove the air filter.**

Hold the release buttons of the air filter, while pulling down it.

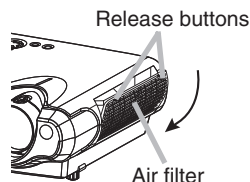

**5 Wipe the dust-detecting window by using a soft cloth.**

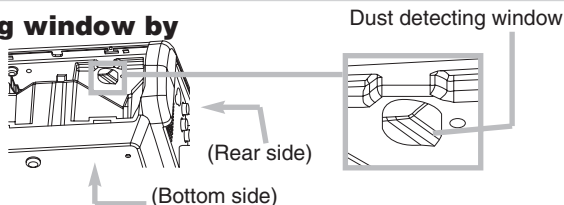

**6 Replace the air filter and filter cover.**



## Troubleshooting (continued)

### Regarding The Indicator Lamps

**ATTENTION** • When the interior portion has become overheated, for safety purposes, the power source is automatically turned off, and the indicator lamps may also be turned off. In such a case, press the “○” (power OFF) side of the main power switch, and wait at least 45 minutes. After the unit has sufficiently cooled down, please make confirmation of the attachment state of the lamp and lamp cover, and then turn the power on again.

Lighting and flashing of the POWER indicator, the LAMP indicator, and the TEMP indicator have the meanings as described in the table below. Please respond in accordance with the instructions within the table. If the same indication is displayed after the treatment, or if an indication other than the following is displayed, please contact your dealer or service company.

POWER indicator	LAMP indicator	TEMP indicator	Description
Lighting in orange	Turned off	Turned off	The unit is in a standby state. Please refer to the “Power ON/OFF” section of this manual.
Flashing in green	Turned off	Turned off	The unit is warming up. Please wait.
Lighting in green	Turned off	Turned off	The unit is in an ON state. Ordinary operations may be performed.
Flashing in orange	Turned off	Turned off	The unit is cooling down. Please wait.
Blinking in red	-	-	The unit is cooling down. A certain error has been detected. Wait until the POWER indicator has finished flashing, and then perform the proper response measure using the item descriptions below as reference.
Lighting or blinking in red	Lighting in red	Turned off	The projector lamp has not been properly fixed (attached), the projector lamp does not light, and/or there is a possibility that the interior portion has become heated. Turn the power OFF and wait at least 20 minutes. After the unit has sufficiently cooled down, please make confirmation of the following items, and then turn the power ON again. If the same indication is displayed, please change the lamp. <ul style="list-style-type: none"><li>• Is there blockage of the air passage aperture?</li><li>• Is the air filter is dirty?</li><li>• Does the peripheral temperature exceed 35°C?</li></ul>
Lighting or blinking in red	Blinking in red	Turned off	The lamp cover has not been properly fixed (attached). Turn the power OFF and wait at least 45 minutes. After the unit has sufficiently cooled down, please make confirmation of the attachment state of the lamp and lamp cover, and then turn the power ON again.

## Troubleshooting (continued)

### Regarding The Indicator Lamps (continued)

POWER indicator	LAMP indicator	TEMP indicator	Description
Lighting or blinking in red	Turned off	Blinking in red	The cooling fan is not operating. Turn the power OFF and wait at least 20 minutes. After the unit has sufficiently cooled down, please make confirmation of the following item, and then resent the power to ON. <ul style="list-style-type: none"> <li>• Is there no foreign matter caught in the cooling fan?</li> </ul>
Lighting or blinking in red	Turned off	Lighting in red	There is a possibility that the interior portion has become heated. Turn the power OFF and wait at least 20 minutes. After the unit has sufficiently cooled down, please make confirmation of the following item, and then resent the power to ON. <ul style="list-style-type: none"> <li>• Is there blockage of the air passage aperture?</li> <li>• Is the air filter is dirty?</li> <li>• Does the peripheral temperature exceed 35°C?</li> </ul>
Lighting in green	Alternative blinking in the red		There is a possibility that the interior portion has become overcooled. Please use the unit within the usage temperature parameters (0°C to 35°C). After the treatment, resent the power to ON.
Lighting in green	Simultaneous blinking in red		It is time to clean the air filter, or there is no air filter. Please immediately turn the power OFF, and clean or change the air filter by referring to the "Air Filter" section of this manual. After you have cleaned or changed the air filter, please be sure to reset the filter timer. After the treatment, resent the power to ON.

## Troubleshooting (continued)

### Phenomena That May Easily Be Mistaken For Machine Defects

**⚠ WARNING** • Please carefully read the “User’s Manual - Safety Guide”.

Never use the projector if abnormal operations such as smoke, strange odor, excessive sound, damaged casing or elements or cables, penetration of liquids or foreign matter, etc. should occur.

**NOTE** • Although bright spots or dark spots may appear on the screen, this is a unique characteristic of liquid crystal displays, and such do not constitute or imply a machine defect.

Before requesting repair, please check in accordance with the following chart. If the situation cannot be corrected, then contact your dealer.

Phenomenon	Cases not involving a machine defect, and Items to be confirmed	Reference pages
Power does not come ON.	<b>The main power source is not ON.</b> Turn on the main power.	11, 14
	<b>The electrical power cord is not plugged in.</b> Correctly connect the power cord.	
	<b>The main power source has been interrupted during operation, such as by a power outage (blackout), etc.</b> Be sure to press the “O” (power OFF) side of the main power switch, and leave this OFF for at least 20 minutes. After the unit has sufficiently cooled down, turn ON the power source.	14
Neither sounds nor pictures are outputted.	<b>The input changeover settings are mismatched.</b> Select the input signal, and correct the settings.	15
	<b>No signal is being inputted.</b> Correctly connect the connection cables.	10
Pictures are displayed, but no sounds are heard.	<b>The electrical wiring to this unit is not correctly connected.</b> Correctly connect the connection cables.	10
	<b>The volume setting has been set at (or adjusted to) an extremely low level.</b> Adjust the VOLUME setting to a higher level.	17
	<b>The MUTE mode is the current setting.</b> Press the MUTE button to release (change) the MUTE mode setting.	17
Sounds are heard, but no pictures are displayed.	<b>The electrical wiring to this unit is not correctly connected.</b> Correctly connect the connection cables.	10
	<b>The brightness setting has been set at (or adjusted to) an extremely low level.</b> Adjust the BRIGHT setting to a brighter level.	23
	<b>The lens cap has not been removed.</b> Remove the lens cap.	4, 14
Colors have a faded- out appearance, or Color tone is poor.	<b>Color settings are not correctly adjusted.</b> Perform picture adjustments by changing the COLOR BAL R, COLOR BAL G, COLOR BAL B, COLOR, and/or the TINT settings, etc.	24

## Troubleshooting (continued)

### Phenomena That May Easily Be Mistaken For Machine Defects (continued)

Phenomenon	Cases not involving a machine defect, and Items to be confirmed	Reference pages
Pictures appear dark.	<b>The brightness setting and/or contrast setting has not been properly adjusted.</b> Perform picture adjustments by changing the BRIGHT and/or CONTRAST settings, etc.	23
	<b>The WHISPER mode is the current setting.</b> Change (by releasing) from the WHISPER mode.	
	<b>Lamp is approaching the end of its product lifetime.</b> Exchange the old lamp with a new lamp.	32,33
Pictures appear blurry.	<b>Either the FOCUS setting or the H PHASE is not properly adjusted.</b> Adjust the focus and the H PHASE setting.	15,26
	<b>The lens is dirty or misty.</b> Clean the lens.	36

### Warranty And After-Service

If a problem occurs with the equipment, first refer to the "Troubleshooting" section of this manual, and run through the suggested checks. If this does not resolve the problem contact your dealer or service company. They will tell you what warranty condition is applied.

# Specifications

Item		Specification
Product name		Liquid crystal projector
Liquid crystal panel	Panel size	1.4 cm (0.55 type)
	Drive system	TFT active matrix
	Pixels	480,000 pixels (800 horizontal x 600 vertical)
Lens		Zoom lens F=1.6 ~ 1.8 f=16.8 ~ 20.1 mm
Lamp		160W UHB
Speaker		1.0W
Power supply		AC100 ~ 120V, 2.6A / AC220 ~ 240V, 1.4A
Power consumption		240W
Temperature range		0 ~ 35°C (Operating)
Size		332 (W) x 92 (H) x 254 (D) mm (Not including protruding parts)
Weight (mass)		3.0 kg
Ports	<b>RGB Input Port</b> RGB IN .....1 <b>RGB Output Port</b> RGB OUT.....1 <b>VIDEO Input Ports</b> VIDEO .....1 S-VIDEO .....1 COMPONENT VIDEO (CR/Pr, Cb/Pb, Y) .....1 <b>AUDIO Input Ports</b> AUDIO IN.....1 AUDIO R, L.....1 <b>AUDIO Output Port</b> AUDIO OUT.....1 <b>CONTROL Port</b> CONTROL .....1 <b>USB Port</b> USB .....1	
Optional Parts		Lamp: DT00621 Air Filter: NJ08292 For others, consult your dealer.

**NOTE** • This specifications are subject to change without notice.

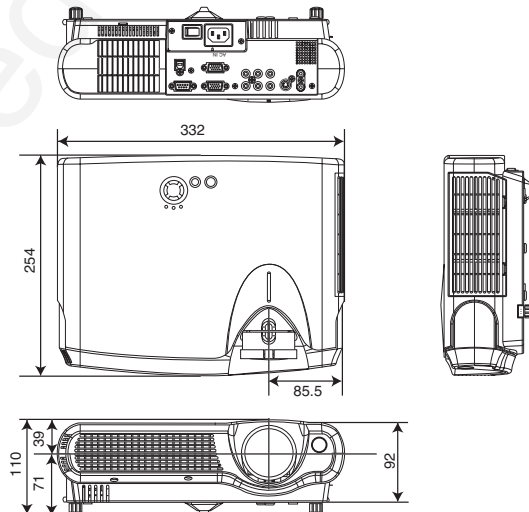

## **PLEASE READ**

This manual is provided as a free service by Projector.com.

We are in no way responsible for the contents of the manual. We do not guarantee its accuracy and we do not make any claim of copyright. The copyright remains the property of their respective owners.

## **ABOUT PROJECTOR.COM**

Projector.com (<http://www.projector.com>) is your review and buying guide resource for DLP and LCD video projectors.

Visit the site to read the latest projector news and reviews, read and comment on projector specifications, download user manuals and much more.