

**NEC**

***Portable Projector***

# **VT660K/VT560/VT465**

***User's Manual***

---





# Important Information

## Safety Cautions

### Precautions

Please read this manual carefully before using your NEC VT660K/VT560/VT465 Projector and keep the manual handy for future reference. Your serial number is located on the bottom of your projector. Record it here:

	<p><b>CAUTION</b> To turn off main power, be sure to remove the plug from power outlet. The power outlet socket should be installed as near to the equipment as possible, and should be easily accessible.</p>
---	--

	<p><b>CAUTION</b> TO PREVENT SHOCK, DO NOT OPEN THE CABINET. NO USER-SERVICEABLE PARTS INSIDE. REFER SERVICING TO QUALIFIED NEC SERVICE PERSONNEL.</p>
---	--

 This symbol warns the user that uninsulated voltage within the unit may be sufficient to cause electrical shock. Therefore, it is dangerous to make any kind of contact with any part inside of the unit.

 This symbol alerts the user that important information concerning the operation and maintenance of this unit has been provided.  
The information should be read carefully to avoid problems.

<p><b>WARNING</b> TO PREVENT FIRE OR SHOCK, DO NOT EXPOSE THIS UNIT TO RAIN OR MOISTURE. DO NOT USE THIS UNIT'S PLUG WITH AN EXTENSION CORD OR IN AN OUTLET UNLESS ALL TWO PRONGS CAN BE FULLY INSERTED. DO NOT OPEN THE CABINET. THERE ARE HIGH-VOLTAGE COMPONENTS INSIDE. ALL SERVICING MUST BE DONE BY QUALIFIED NEC SERVICE PERSONNEL.</p>
--

### DOC Compliance Notice

This Class B digital apparatus meets all requirements of the Canadian Interference-Causing Equipment Regulations.

### Acoustic Noise Information Ordinance-3. GSGV:

The sound pressure level is less than 70 dB (A) according to ISO 3744 or ISO 7779.

	<p><b>CAUTION</b></p> <ul style="list-style-type: none"><li>Avoid displaying stationary images for a prolonged period of time. Doing so can result in these images being temporarily sustained on the surface of the LCD panel. If this should happen, continue to use your projector. The static background from previous images will disappear.</li><li>Do not put the projector on its side when the lamp is turned on. Doing so may cause damage to the projector.</li></ul>
---	--

## RF Interference

<p><b>WARNING</b> The Federal Communications Commission does not allow any modifications or changes to the unit EXCEPT those specified by NEC Solutions (America), Inc. in this manual. Failure to comply with this government regulation could void your right to operate this equipment. This equipment has been tested and found to comply with the limits for a Class B digital device, pursuant to Part 15 of the FCC Rules. These limits are designed to provide reasonable protection against harmful interference in a residential installation. This equipment generates, uses, and can radiate radio frequency energy and, if not installed and used in accordance with the instructions, may cause harmful interference to radio communications. However, there is no guarantee that interference will not occur in a particular installation. If this equipment does cause harmful interference to radio or television reception, which can be determined by turning the equipment off and on, the user is encouraged to try to correct the interference by one or more of the following measures:</p> <ul style="list-style-type: none"><li>Reorient or relocate the receiving antenna.</li><li>Increase the separation between the equipment and receiver.</li><li>Connect the equipment into an outlet on a circuit different from that to which the receiver is connected.</li><li>Consult the dealer or an experienced radio / TV technician for help.</li></ul>
---

In UK, a BS approved power cable with moulded plug has a Black (five Amps) fuse installed for use with this equipment. If a power cable is not supplied with this equipment please contact your supplier.

### Important Safeguards

These safety instructions are to ensure the long life of your projector and to prevent fire and shock. Please read them carefully and heed all warnings.

### Installation

- For best results, use your projector in a darkened room.
- Place the projector on a flat, level surface in a dry area away from dust and moisture.
- Do not place your projector in direct sunlight, near heaters or heat radiating appliances.
- Exposure to direct sunlight, smoke or steam can harm internal components.
- Handle your projector carefully. Dropping or jarring can damage internal components.
- Do not place heavy objects on top of the projector.
- If you wish to have the projector installed on the ceiling:
  - Do not attempt to install the projector yourself.
  - The projector must be installed by qualified technicians in order to ensure proper operation and reduce the risk of bodily injury.
  - In addition, the ceiling must be strong enough to support the projector and the installation must be in accordance with any local building codes.
  - Please consult your dealer for more information.

## Fire and Shock Precautions

1. Ensure that there is sufficient ventilation and that vents are unobstructed to prevent the build-up of heat inside your projector. Allow at least 3 inches (10 cm) of space between your projector and a wall.
2. Prevent foreign objects such as paper clips and bits of paper from falling into your projector.  
Do not attempt to retrieve any objects that might fall into your projector. Do not insert any metal objects such as a wire or screwdriver into your projector. If something should fall into your projector, disconnect it immediately and have the object removed by a qualified NEC service personnel.
3. Do not place any liquids on top of your projector.
4. Do not look into the lens while the projector is on. Serious damage to your eyes could result.
5. Keep any items such as magnifying glass out of the light path of the projector. The light being projected from the lens is extensive, therefore any kind of abnormal objects that can redirect light coming out of the lens, can cause unpredictable outcome such as fire or injury to the eyes.
6. Do not cover the lens with the supplied lens cap or equivalent while the projector is on. Doing so can lead to melting of the cap and possibly burning your hands due to the heat emitted from the light output.
7. The projector is designed to operate on a power supply of 100-120 or 200-240 V 50/60 Hz AC. Ensure that your power supply fits this requirement before attempting to use your projector.
8. Handle the power cable carefully and avoid excessive bending. A damaged cord can cause electric shock or fire.
9. If the projector is not to be used for an extended period of time, disconnect the plug from the power outlet.
10. Do not touch the power plug during a thunderstorm. Doing so can cause electrical shock or fire.

## CAUTION

1. Do not try to touch the ventilation outlet on the left side (when seen from the front) as it can become heated while the projector is turned on.
2. Do not use the tilt-foot for purposes other than originally intended. Misuses such as gripping the tilt-foot or hanging on the wall can cause damage to the projector.
3. When carrying the projector by the carrying handle, make sure the two screws that attach the carrying handle to the projector cabinet are tight.  
Insufficient tightening of the two screws could result in the projector falling and causing injury.
4. Do not send the soft carrying case by parcel delivery service or cargo shipment. The projector inside the soft carrying case could be damaged. (However, it is possible to use it as a carryercase on board.)
5. Enable High-Speed Fan mode if you continue to use the projector for consecutive days. (From the menu, select [Advanced] → [High Speed Fan Mode].)
6. Do not unplug the power cable from the wall outlet under any one of the following circumstances.  
Doing so can cause damage to the projector:
  - \* While the Hour Glass icon appears.
  - \* While the cooling fans are running. (The cooling fans continue to work for 60 seconds after the projector is turned off).

## Lamp Replacement

- To replace the lamp, follow all instructions provided on page E-30.
- Be sure to replace the lamp when the message "The lamp has reached the end of its usable life. Please replace the lamp." appears. If you continue to use the lamp after the lamp has reached the end of its usable life, the lamp bulb may shatter, and pieces of glass may be scattered in the lamp case. Do not touch them as the pieces of glass may cause injury.  
If this happens, contact your NEC dealer for lamp replacement.

- Allow a minimum of 60 seconds to elapse after turning off the projector. Then turn off the main power switch, disconnect the power cable and allow 60 minutes to cool the projector before replacing the lamp.

## What's in the Box?

Make sure your box contains everything listed. If any pieces are missing, contact your dealer.  
Please save the original box and packing materials if you ever need to ship your VT660K/VT560/VT465 Projector.

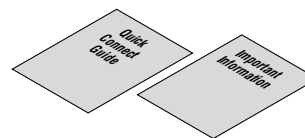
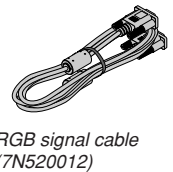
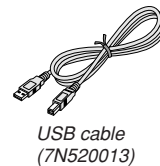
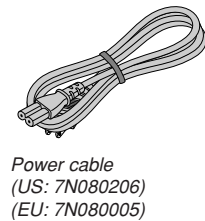
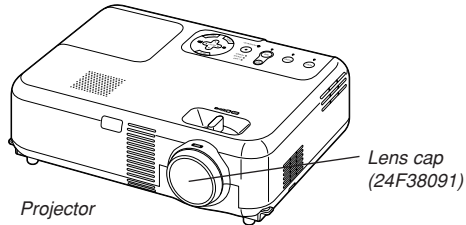

**For North America only**  
Registration card  
Limited warranty

**For Europe only**  
Guarantee policy

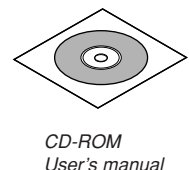

# TABLE OF CONTENTS

<b>Important Information</b> .....	<b>E-2</b>	<b>MAINTENANCE</b> .....	<b>E-30</b>
Safety Cautions .....	E-2	Replacing the Lamp .....	E-30
What's in the Box? .....	E-3	Cleaning .....	E-31
		Cleaning or Replacing the Filter .....	E-31
		Cleaning the Cabinet and the Lens .....	E-31
<b>INTRODUCTION</b> .....	<b>E-5</b>	<b>TROUBLESHOOTING</b> .....	<b>E-32</b>
Introduction to the Projector .....	E-5	Power Indicator .....	E-32
Part Names of the Projector .....	E-6	Status Indicator .....	E-32
Attaching the supplied carrying handle .....	E-6	Lamp Indicator .....	E-32
Top Features .....	E-7	Common Problems & Solutions .....	E-33
Terminal Panel Features .....	E-8		
Part Names of the Remote Control .....	E-9		
Battery Installation .....	E-10		
Remote Control Precautions .....	E-10		
Operating Range for Wireless Remote Control .....	E-10		
<b>INSTALLATION AND CONNECTIONS</b> .....	<b>E-11</b>	<b>SPECIFICATIONS</b> .....	<b>E-34</b>
Setting Up the Screen and the Projector .....	E-11	<b>APPENDIX</b> .....	<b>E-35</b>
Selecting a Location .....	E-11	Cabinet Dimensions .....	E-35
Throw Distance and Screen Size .....	E-12	Pin Assignments of D-Sub RGB Input Connector .....	E-35
Making Connections .....	E-13	Compatible Input Signal List .....	E-36
Connecting Your PC or Macintosh Computer .....	E-13	PC Control Codes .....	E-37
To connect SCART output (RGB) .....	E-14	Cable Connection .....	E-37
Connecting an External Monitor .....	E-14	TravelCare Guide .....	E-38
Connecting Your DVD Player .....	E-15		
Connecting Your VCR or Laser Disc Player .....	E-16		
Connecting the Supplied Power Cable .....	E-16		
<b>PROJECTING AN IMAGE (BASIC OPERATION)</b> .....	<b>E-17</b>		
Turning on the Projector .....	E-17		
Selecting a Source .....	E-18		
Adjusting the Picture Size and Position .....	E-18		
Correcting the Vertical Keystone Distortion .....	E-19		
Optimizing RGB Picture Automatically .....	E-20		
Turning Up or Down Volume .....	E-20		
Turning off the Projector .....	E-20		
<b>CONVENIENT FEATURES</b> .....	<b>E-21</b>		
Using the Remote Mouse Function .....	E-21		
Connecting to your computer for the remote mouse function .....	E-21		
When using the USB Port .....	E-21		
Switching operation mode between computer and projector .....	E-21		
Turning off the Image and Sound .....	E-22		
Freezing a Picture .....	E-22		
Enlarging and Moving a Picture .....	E-22		
Getting the Information .....	E-22		
<b>USING ON-SCREEN MENU</b> .....	<b>E-23</b>		
Basic Menu Operation .....	E-23		
Using the Menus .....	E-23		
List of Menu Items .....	E-24		
Menu Elements .....	E-25		
Menu Descriptions & Functions .....	E-26		
Picture .....	E-26		
Brightness/Contrast/Sharpness/Color/Hue .....	E-26		
Picture Management .....	E-26		
Image .....	E-26		
Enabling Auto Keystone [Auto Keystone] .....	E-26		
Correcting Vertical Keystone Distortion Manually [Keystone] .....	E-26		
Saving Vertical Keystone Correction [Keystone Save] .....	E-26		
Selecting Aspect Ratio [Aspect Ratio] .....	E-27		
Adjusting the Vertical Position of Image [Cinema Position](for Cinema only) .....	E-27		
Setup .....	E-27		
Selecting Lamp Mode [Lamp Mode] .....	E-27		
Selecting Menu Language [Language] .....	E-27		
Selecting Menu Color [Menu Color Select] .....	E-27		
Selecting Menu Display Time [Menu Display Time] .....	E-27		
Selecting a Color or Logo for Background [Background] .....	E-27		
Selecting Projector Orientation [Orientation] .....	E-27		
Advanced .....	E-27		
Security .....	E-27		
Disabling the Cabinet Buttons [Control Panel Key Lock] .....	E-28		
Enabling High Speed Fan Mode [High Speed Fan Mode] .....	E-28		
Selecting Signal Format [Signal Select] .....	E-28		
Page2 .....	E-28		
Enabling Power Management [Power Management] .....	E-28		
Selecting Noise Reduction Level [Noise Reduction] .....	E-28		
Enabling Auto Adjust [Auto Adjust] .....	E-29		
Adjusting Position/Clock (when Auto Adjust is off) .....	E-29		
Selecting Communication Speed [Communication Speed] .....	E-29		
Information .....	E-29		
Default .....	E-29		
Returning to Factory Default [Factory Default] .....	E-29		
Resetting the Filter Usage Hours [Clear Filter Usage] .....	E-29		
Clearing Lamp Hour Meter [Clear Lamp Hour Meter] .....	E-29		

# INTRODUCTION

## Introduction to the Projector

This section introduces you to your new VT660K/VT560/VT465 Projector and describes the features and controls.

## Congratulations on Your Purchase of The VT660K/VT560/VT465 Projector

The VT660K/VT560/VT465 is one of the very best projectors available today. The VT660K/VT560/VT465 enables you to project precise images up to 300 inches across (measured diagonally) from your PC or Macintosh computer (desktop or notebook), VCR, DVD player, document camera, or a laser disc player.

You can use the projector on a tabletop or cart, you can use the projector to project images from behind the screen, and the projector can be permanently mounted on a ceiling\*<sup>1</sup>. The remote control can be used wirelessly.

\*<sup>1</sup> Do not attempt to mount the projector on a ceiling yourself.

The projector must be installed by qualified technicians in order to ensure proper operation and reduce the risk of bodily injury.

In addition, the ceiling must be strong enough to support the projector and the installation must be in accordance with any local building codes. Please consult your dealer for more information.

## Features you'll enjoy:

- Auto vertical keystone correction up to +/- 30 degrees
- Low level operation noise
- Short focal length lens
- 205W lamp (164W Eco mode) : VT660K/VT465  
200W lamp (160W Eco mode) : VT560
- Direct keys for source selection
- New Color Management system
- New menu design improves operation
- Safety protect by Security function  
Security feature prevents the projector from being used by unauthorized individuals.  
Keyword prevents unauthorized individuals from changing projector settings or adjustments.
- NEC's exclusive Advanced AccuBlend intelligent pixel blending technology - an extremely accurate image compression technology - offers a crisp image with UXGA (1600 × 1200) resolution\*<sup>2</sup>.
- Supports most IBM VGA, SVGA, XGA, SXGA/UXGA(with Advanced AccuBlend)\*<sup>2</sup>, Macintosh, component signal (YCbCr/ YPbPr) or any other RGB signals within a horizontal frequency range of 24 to 100 kHz and a vertical frequency range of 50 to 120 Hz. This includes NTSC, PAL, PAL-N, PAL-M, PAL60, SECAM and NTSC4.43 standard video signals.

\*<sup>2</sup> A UXGA (1600 × 1200) and SXGA image (1280 × 1024) are displayed with NEC's Advanced AccuBlend on VT660K and VT560.

A UXGA (1600 × 1200), SXGA (1280 × 1024) and XGA (1024 × 768) image are displayed with NEC's Advanced AccuBlend on VT465.

---

**NOTE:** Composite video standards are as follows:

**NTSC:** U.S. TV standard for video in U.S. and Canada.

**PAL:** TV standard used in Western Europe.

**PAL-N:** TV standard used in Argentina, Paraguay and Uruguay.

**PAL-M:** TV standard used in Brazil.

**PAL60:** TV standard used for NTSC playback on PAL TVs.

**SECAM:** TV standard used in France and Eastern Europe.

**NTSC4.43:** TV standard used in Middle East countries.

---

- The supplied remote control can be used without a cable, and you can even use the remote control to operate your PC's mouse wirelessly from across the room with the built-in remote mouse function.
- You can control the projector with a PC using the PC Control port.
- The contemporary cabinet design is light, compact, easy to carry, and complements any office, boardroom or auditorium.

## About this user's manual

The fastest way to get started is to take your time and do everything right the first time. Take a few minutes now to review the user's manual. This may save you time later on. At the beginning of each section of the manual you'll find an overview. If the section doesn't apply, you can skip it.

- IBM is a trademark or registered trademark of International Business Machines Corporation.
- Mac and PowerBook are trademarks of Apple Computer, Inc., registered in the U.S. and other countries.
- Windows, Windows 98, Windows Me, Windows XP or Windows 2000 are trademarks or registered trademarks of Microsoft Corporation.
- Other product and company names mentioned in this user's manual may be the trademarks or registered trademarks of their respective holders.

## Part Names of the Projector

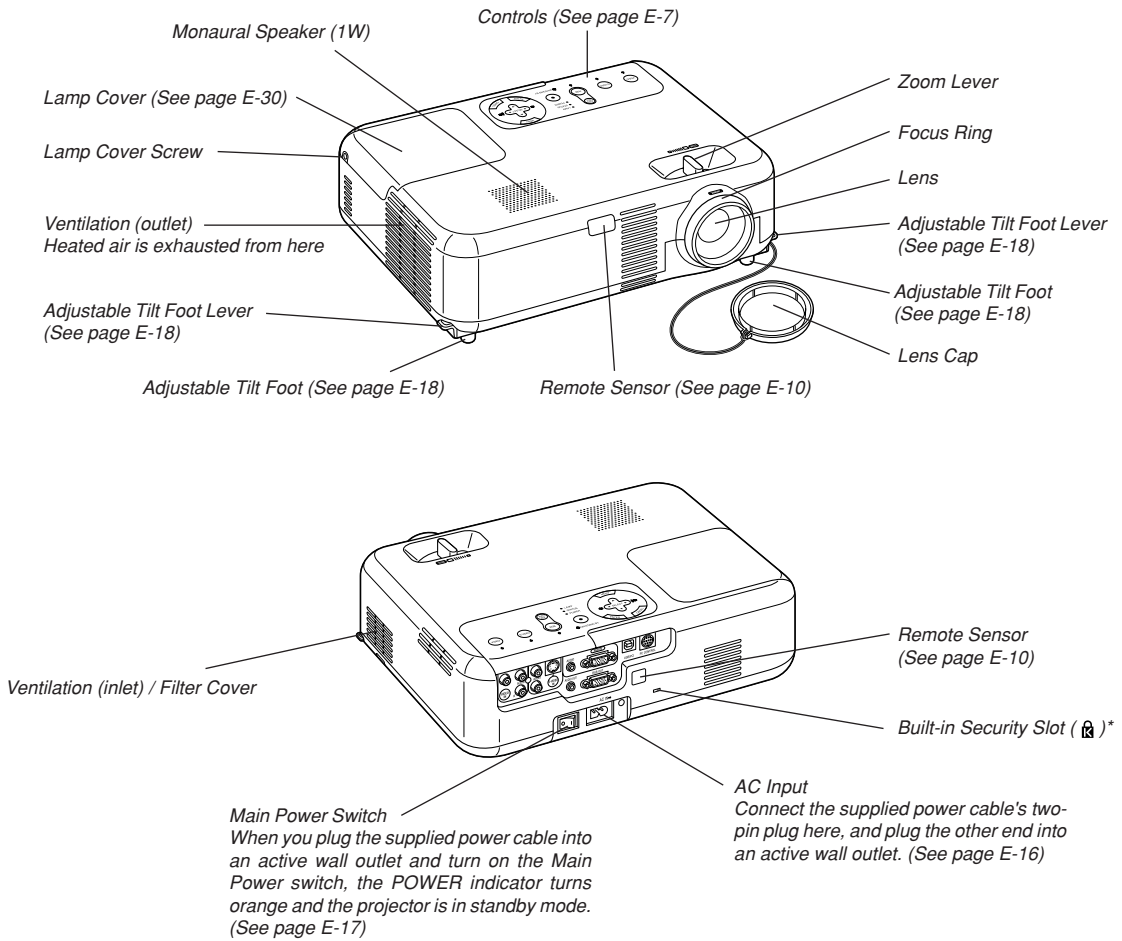

\* This security slot supports the MicroSaver® Security System. MicroSaver® is a registered trademark of Kensington Microware Inc. The logo is trademarked and owned by Kensington Microware Inc.

### Attaching the supplied carrying handle

You can carry the projector by attaching the supplied carrying handle securely to the projector.

To attach the supplied carrying handle, use the supplied flathead screwdriver and two screws.

Place a soft cloth on the working surface before turning the projector over to prevent scratching the top cover. Make sure that the carrying handle is attached with correct orientation as shown below.

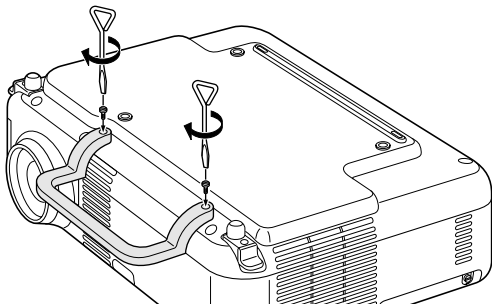

#### CAUTION

When carrying the projector by the carrying handle, make sure the two screws that attach the carrying handle to the projector cabinet are tight.

## Top Features

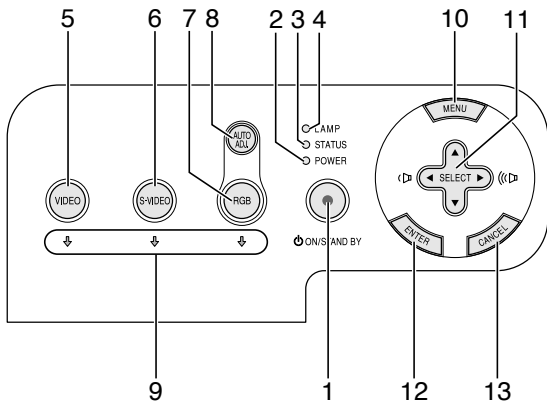

1. **POWER Button (ON / STAND BY)** ( )  
Use this button to turn the power on and off when the main power is supplied and the projector is in standby mode.  
To turn on the projector, press and hold this button for a minimum of two seconds. To turn off the projector, press this button twice.
2. **POWER Indicator**  
When this indicator is green, the projector is on; when this indicator is orange, it is in standby mode. See the Power Indicator section on page E-32 for more details.
3. **STATUS Indicator**  
If this light blinks red rapidly, it indicates that an error has occurred, the lamp cover is not attached properly or the projector has overheated. If this light remains orange, it indicates that you have pressed a cabinet key while the Control Panel Key Lock is enabled. See the Status Indicator section on page E-32 for more details.
4. **LAMP Indicator**  
If this light blinks red rapidly, it's warning you that the lamp has reached the end of its usable life. After this light appears, replace the lamp as soon as possible (See page E-30). If this is lit green continually, it indicates that the lamp mode is set to Eco. See the Lamp Indicator section on page E-32 for more details.
5. **VIDEO Button**  
Press this button to select a video source from a VCR, DVD player, laser disc player or document camera.
6. **S-VIDEO Button**  
Press this button to select an S-Video source from a VCR, DVD player, laser disc player or document camera.
7. **RGB Button**  
Press this button to select an RGB source from computer or component equipment connected to your RGB port.
8. **AUTO ADJ. Button**  
Use this button to adjust Position-H/V and Pixel Clock/Phase for an optimal picture (See page E-20).
9. **Source Indicators**  
When one of the RGB, VIDEO or S-VIDEO input is selected, the corresponding source indicator lights.
10. **MENU Button**  
Displays the menu.

11. **SELECT**  / Volume Buttons  
  - : Use these buttons to select the menu of the item you wish to adjust.
  - : Use these buttons to change the level of a selected menu item. A press of the button executes the selection. When no menus appear, these buttons work as a volume control.

When an image is magnified, the SELECT button moves the image.
12. **ENTER Button**  
Executes your menu selection and activates items selected from the menu.
13. **CANCEL Button**  
Pressing this button will return to the previous menu.  
While you are in the main menu, pressing this button will close the menu.

## Terminal Panel Features

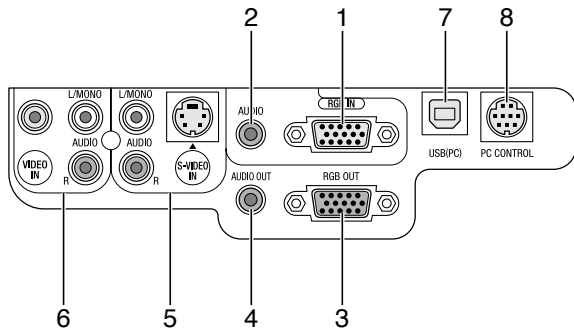

- 1. RGB IN / Component Input Connector (Mini D-Sub 15 Pin)**  
Connect your computer or other analog RGB equipment such as IBM compatible or Macintosh computers. Use the supplied RGB cable to connect to your computer. This also serves as a component input connector that allows you to connect a component video output of component equipment such as a DVD player. This connector also supports SCART output signal. See page E-14 for more details.
- 2. RGB AUDIO Input Mini Jack (Stereo Mini)**  
This is where you connect the audio output from your computer or DVD player when connected to the RGB input. A commercially available audio cable is required.
- 3. RGB OUT Connector (Mini D-Sub 15 Pin)**  
You can use this connector to loop your computer image to an external monitor from the RGB input source.  
This connector outputs RGB signal in standby mode.
- 4. AUDIO OUT Mini Jack (Stereo Mini)**  
You can use this jack to output sound from the currently selected source (RGB, VIDEO or S-VIDEO). Output sound level can be adjusted in accordance with the sound level of the internal speaker.  
Note that this cannot be used as a headphone jack.  
(When audio equipment is connected, the projector speaker is disabled.)  
When a cable mini-plug is inserted into this jack, both the right and left audio signals are not mixed, but separate.  
For example, when a cable mini-plug is inserted into the left AUDIO IN jack only, only left sound is output.
- 5. S-VIDEO IN Connector (Mini DIN 4 Pin)**  
Here is where you connect the S-Video input from an external source like a VCR.  
**NOTE:** *S-Video provides more vivid color and higher resolution than the traditional composite video format.*  
**S-VIDEO AUDIO Input Jacks R/L (RCA)**  
These are your left and right channel audio inputs for stereo sound from an S-Video source.
- 6. VIDEO IN Connector (RCA)**  
Connect a VCR, DVD player, laser disc player, or document camera here to project video.  
**VIDEO AUDIO Input Jacks R/L (RCA)**  
These are your left and right channel audio inputs for stereo sound from a Video source.
- 7. USB (PC) Port (Type B)**  
Connect this port to the USB port (type A) of your PC using the supplied USB cable. You can operate your computer's mouse functions from the remote control.
- 8. PC CONTROL Port (DIN 8 Pin)**  
Use this port to connect your PC to control your projector. This enables you to use your PC and serial communication protocol to control the projector. If you are writing your own program, typical PC control codes are on page E-37.



## Part Names of the Remote Control

**NOTE:** If you are using a Macintosh computer, you can click either the CANCEL (right-click) or ENTER (left-click) button to activate the mouse.

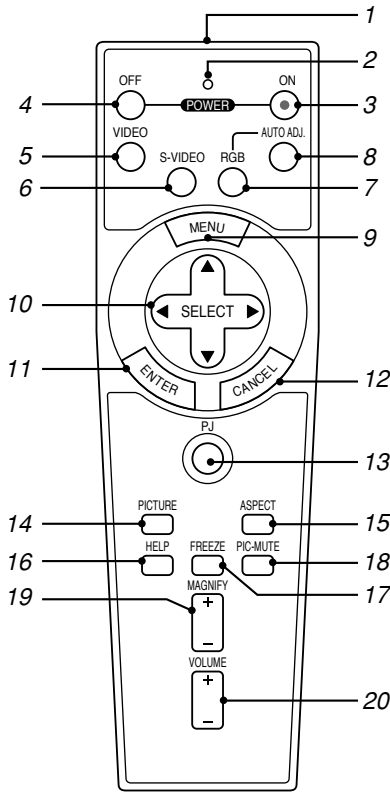

1. Infrared Transmitter  
Direct the remote control toward the remote sensor on the projector cabinet.
2. LED  
Flashes when any button is pressed.
3. POWER ON Button  
When the main power is on, you can use this button to turn your projector on.  
**NOTE:** To turn on the projector, press and hold the POWER ON button for a minimum of two seconds.
4. POWER OFF Button  
You can use this button to turn your projector off.  
**NOTE:** To turn off the projector, press the POWER OFF button twice.
5. VIDEO Button  
Press this button to select a video source from a VCR, DVD player, laser disc player or document camera.
6. S-VIDEO Button  
Press this button to select an S-Video source from a VCR.
7. RGB Button  
Press this button to select RGB input.
8. AUTO ADJ. Button  
Use this button to adjust an RGB source for an optimal picture. See page E-20.

9. MENU Button  
Displays the menu for various settings and adjustments.
10. SELECT ▲▼◀▶ (Mouse) Button  
When you are in the Computer mode, these buttons work as a computer mouse.  
When you are in the Projector mode, which is indicated by lighting the PJ button. See page E-21.  
▲▼ : Use these buttons to select the menu of the item you wish to adjust.  
◀▶ : Use these buttons to change the level of a selected menu item. A press of the ▶ button executes the selection. When no menu appear, these buttons work as a volume control.  
When an image is magnified, the SELECT ▲▼◀▶ button moves the image.
11. ENTER (Left Click) Button  
When you are in the Computer mode, this button works as the mouse left button. When this button is pressed and held for a minimum of 2 seconds, the drag mode is set. When you are in the Projector mode, which is indicated by lighting the PJ button: Use this button to enter your menu selection. It works the same way as the ENTER button on the cabinet. See page E-7.
12. CANCEL (Right Click) Button  
When you are in the Computer mode, this button works as the mouse right button. When you are in the Projector mode, which is indicated by lighting the PJ button: Use this button to enter your menu selection. It works the same way as the CANCEL button on the cabinet. See page E-7.
13. PJ Button  
Press this button to switch the SELECT, CANCEL, and ENTER buttons between the Projector mode (lit red) and the Computer mode. Press this button or any one of the POWER ON/OFF, MENU, ASPECT, HELP, MAGNIFY, buttons to switch to the Projector mode and the PJ button lights red. To switch back to the Computer mode, press the PJ button again. See page E-21.
14. PICTURE Button  
Press this button to display the Picture adjustment screen such as Brightness, Contrast, Sharpness, Color and Hue. See page E-26.
15. ASPECT Button  
Press this button to display the Aspect Ratio select screen. See page E-27.
16. HELP Button  
Provides the set information.
17. FREEZE Button  
This button will freeze a picture. Press again to resume motion.
18. PIC-MUTE Button  
This button turns off the image and sound for a short period of time. Press again to restore the image and sound.
19. MAGNIFY (+)(-) Button  
Use this button to adjust the image size up to 400%. The image is magnified about the center of the screen. See page E-22.
20. VOLUME (+)(-) Button  
Press (+) to increase the volume and (-) to decrease it.

**NOTE:** The default is the Computer mode, which allows you to use the SELECT, CANCEL, and ENTER buttons as your computer mouse. When the POWER ON/OFF, MENU, ASPECT, HELP, or MAGNIFY button is pressed, the PJ button lights red to indicate that you are in the Projector mode. If no buttons are pressed within 60 seconds, the light goes out and the Projector mode is canceled.

## Battery Installation

1. Press firmly and slide the battery cover off.

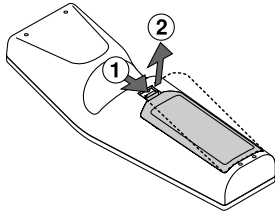

2. Remove both old batteries and install new ones (AA). Ensure that you have the batteries' polarity (+/-) aligned correctly.

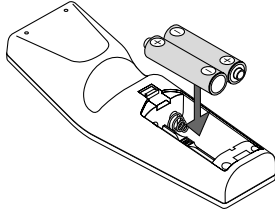

3. Slip the cover back over the batteries until it snaps into place. Do not mix different types of batteries or new and old batteries.

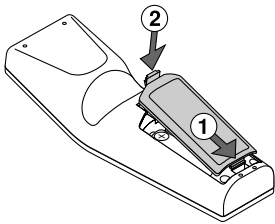

### Note on Remote Control Operation:

If you press and hold the SELECT  $\blacktriangle\blacktriangledown\blacktriangleleft\blacktriangleright$  button while installing new batteries, the remote control may fail to work properly. Should this happen, remove the batteries and then install them again without touching the SELECT button.

## Remote Control Precautions

- Handle the remote control carefully.
- If the remote control gets wet, wipe it dry immediately.
- Avoid excessive heat and humidity.
- If you will not be using the remote control for a long time, remove the batteries.
- Do not place the batteries upside down.
- Do not use new and old batteries together, or use different types of batteries together.

## Operating Range for Wireless Remote Control

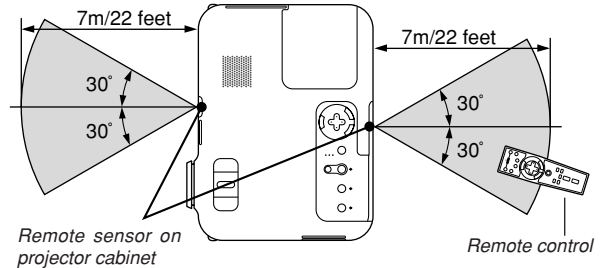

- The infrared signal operates by line-of-sight up to a distance of about 22 feet/7 m and within a 60-degree angle of the remote sensor on the projector cabinet.
- The projector will not respond if there are objects between the remote control and the sensor, or if strong light falls on the sensor. Weak batteries will also prevent the remote control from properly operating the projector.

# INSTALLATION AND CONNECTIONS

This section describes how to set up your projector and how to connect video and audio sources.

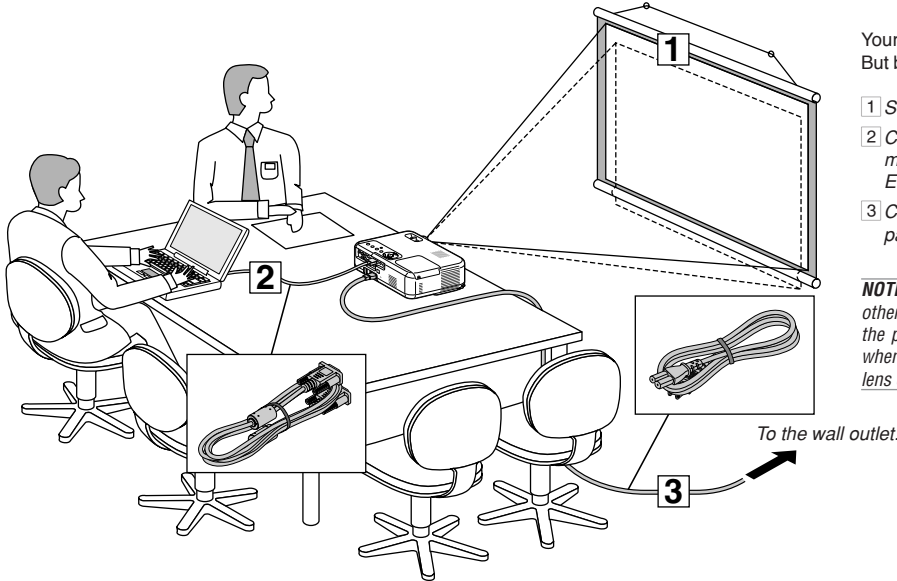

Your projector is simple to set up and use. But before you get started, you must first:

- 1 Set up a screen and the projector.
- 2 Connect your computer or video equipment to the projector. See page E-13 – 16.
- 3 Connect the supplied power cable. See page E-16.

**NOTE:** Ensure that the power cable and any other cables are disconnected before moving the projector. When moving the projector or when it is not in use, cover the lens with the lens cap.

## Setting Up the Screen and the Projector

### Selecting a Location

The further your projector is from the screen or wall, the larger the image. The minimum size the image can be is approximately 21" (0.53 m) measured diagonally when the projector is roughly 27.6 inches (0.7 m) from the wall or screen. The largest the image can be is 300" (7.6 m) when the projector is about 393.7 inches (10 m) from the wall or screen. Use the drawing below as a guide.

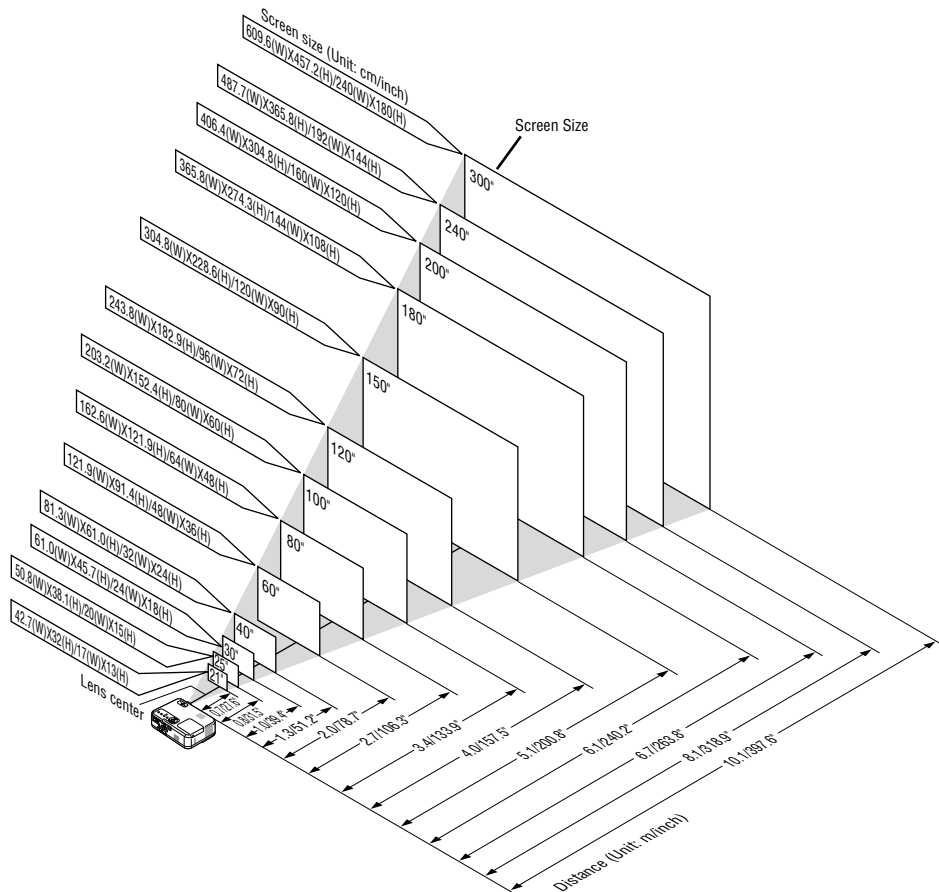

## Throw Distance and Screen Size

The following shows the proper relative positions of the projector and screen. Refer to the table to determine the position of installation.

### Distance Chart

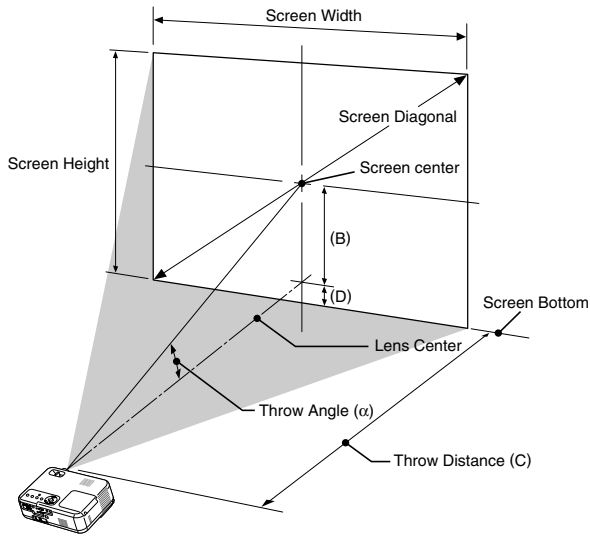

B = Vertical distance between lens center and screen center  
 C = Throw distance  
 D = Vertical distance between lens center and top of screen (bottom of screen for desktop)  
 $\alpha$  = Throw angle

**NOTE:** Distances may vary +/-5%.

Screen Size			B inch	C		D inch	$\alpha$	
Diagonal inch	Width inch	Height inch		Wide - Tele inch	Tele - Wide inch		Wide - Tele degree	Tele - Wide degree
21	17	13	5	— - 29	1	— - 10.0	— - 10.0	
25	20	15	6	29 - 35	1	11.8 - 9.9	11.8 - 9.9	
30	24	18	7	35 - 42	2	11.7 - 9.8	11.7 - 9.8	
40	32	24	10	47 - 57	2	11.6 - 9.7	11.6 - 9.7	
60	48	36	15	71 - 86	3	11.5 - 9.6	11.5 - 9.6	
72	58	43	17	86 - 103	4	11.4 - 9.6	11.4 - 9.6	
80	64	48	19	96 - 115	5	11.4 - 9.6	11.4 - 9.6	
84	67	50	20	101 - 121	5	11.4 - 9.6	11.4 - 9.6	
90	72	54	22	108 - 129	5	11.4 - 9.5	11.4 - 9.5	
100	80	60	24	120 - 144	6	11.4 - 9.5	11.4 - 9.5	
120	96	72	29	144 - 173	7	11.4 - 9.5	11.4 - 9.5	
150	120	90	36	181 - 217	9	11.4 - 9.5	11.4 - 9.5	
180	144	108	44	217 - 260	10	11.3 - 9.5	11.3 - 9.5	
200	160	120	48	241 - 290	12	11.3 - 9.5	11.3 - 9.5	
210	168	126	51	253 - 304	12	11.3 - 9.5	11.3 - 9.5	
240	192	144	58	290 - 348	14	11.3 - 9.5	11.3 - 9.5	
270	216	162	65	326 - 391	16	11.3 - 9.5	11.3 - 9.5	
300	240	180	73	363 - 400	17	11.3 - 9.5	11.3 - 9.5	

Screen Size			B mm	C		D mm	$\alpha$	
Diagonal mm	Width mm	Height mm		Wide - Tele mm	Tele - Wide mm		Wide - Tele degree	Tele - Wide degree
533	427	320	130	— - 740	30	— - 10.0	— - 10.0	
635	508	381	150	740 - 880	40	11.8 - 9.9	11.8 - 9.9	
762	610	457	180	890 - 1070	40	11.7 - 9.8	11.7 - 9.8	
1016	813	610	250	1200 - 1440	60	11.6 - 9.7	11.6 - 9.7	
1524	1219	914	370	1810 - 2180	90	11.5 - 9.6	11.5 - 9.6	
1829	1463	1097	440	2180 - 2620	110	11.4 - 9.6	11.4 - 9.6	
2032	1626	1219	490	2430 - 2920	120	11.4 - 9.6	11.4 - 9.6	
2134	1707	1280	520	2550 - 3060	120	11.4 - 9.6	11.4 - 9.6	
2286	1829	1372	550	2740 - 3290	130	11.4 - 9.5	11.4 - 9.5	
2540	2032	1524	610	3050 - 3660	150	11.4 - 9.5	11.4 - 9.5	
3048	2438	1829	740	3660 - 4400	180	11.4 - 9.5	11.4 - 9.5	
3810	3048	2286	920	4590 - 5510	220	11.4 - 9.5	11.4 - 9.5	
4572	3658	2743	1110	5510 - 6610	270	11.3 - 9.5	11.3 - 9.5	
5080	4064	3048	1230	6130 - 7350	300	11.3 - 9.5	11.3 - 9.5	
5334	4267	3200	1290	6440 - 7720	310	11.3 - 9.5	11.3 - 9.5	
6096	4877	3658	1470	7360 - 8830	350	11.3 - 9.5	11.3 - 9.5	
6858	5486	4115	1660	8290 - 9940	400	11.3 - 9.5	11.3 - 9.5	
7620	6096	4572	1840	9210 - 11050	440	11.3 - 9.5	11.3 - 9.5	

### WARNING

- \* **Installing your projector on the ceiling must be done by a qualified technician. Contact your NEC dealer for more information.**
- \* **Do not attempt to install the projector yourself.**
- Only use your projector on a solid, level surface. If the projector falls to the ground, you can be injured and the projector severely damaged.
- Do not use the projector where temperatures vary greatly. The projector must be used at temperatures between 32°F (0°C) and 95°F (35°C).
- Do not expose the projector to moisture, dust, or smoke. This will harm the screen image.
- Ensure that you have adequate ventilation around your projector so heat can dissipate. Do not cover the vents on the side or the front of the projector.

### Reflecting the Image

Using a mirror to reflect your projector's image enables you to enjoy a much larger image. Contact your NEC dealer if you need a mirror. If you're using a mirror and your image is inverted, use the MENU and SELECT buttons on your projector cabinet or your remote control to correct the orientation. (See page E-27.)

## Making Connections

**NOTE:** When using with a notebook PC, be sure to connect between the projector and the notebook PC before turning on the power to the notebook PC. In most cases signal cannot be output from RGB output unless the notebook PC is turned on after connecting with the projector.

\* If the screen goes blank while using your remote control, it may be the result of the computer's screen-saver or power management software.

\* If you accidentally hit the POWER button on the remote control, wait 60 seconds and then press the POWER button again to resume.

### Connecting Your PC or Macintosh Computer

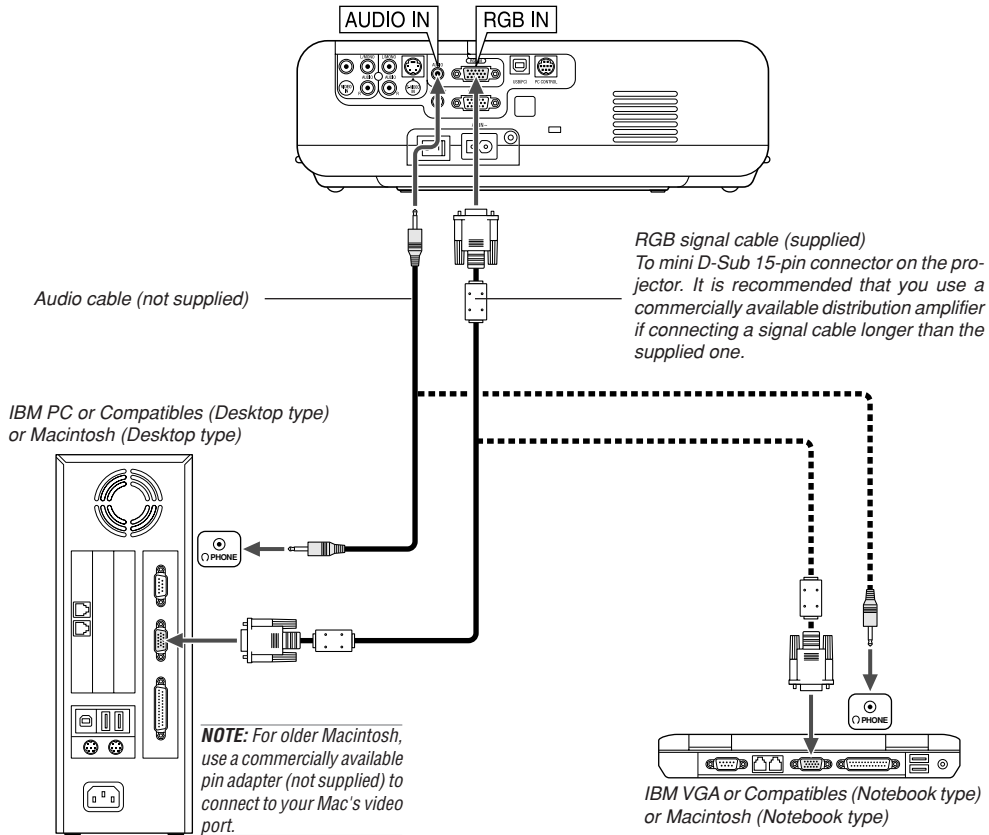

Connecting your PC or Macintosh computer to your projector will enable you to project your computer's screen image for an impressive presentation.

To connect to a PC or Macintosh, simply:

1. Turn off the power to your projector and computer.
2. Use the supplied signal cable to connect your PC or Macintosh to the projector.
3. Turn on the projector and the computer.
4. If the projector goes blank after a period of inactivity, it may be caused by a screen saver installed on the computer you've connected to the projector.

### To connect SCART output (RGB)

Before connections: An exclusive SCART adapter (ADP-SC1) and a commercially available SCART cable are required for this connection.

**NOTE:** Audio signal is not available for this connection.

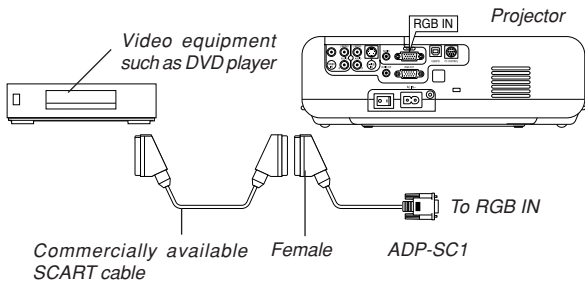

1. Turn off the power to the projector and your video equipment.
2. Use the NEC ADP-SC1 SCART adapter and a commercially available SCART cable to connect the RGB input of your projector and a SCART output (RGB) of your video equipment.
3. Turn on the power to the projector and your video equipment.
4. Use the RGB button on the remote control to select the RGB input.
5. Press the MENU button on the remote control to display the menu.
6. From the menu, select [Advanced] → [Signal Select RGB] → [Scart]. SCART is a standard European audio-visual connector for TVs, VCRs and DVD players. It is also referred to as Euro-connector.

**NOTE:** The ADP-SC1 SCART adapter is obtainable from your NEC dealer in Europe. Contact your NEC dealer in Europe for more information.

### Connecting an External Monitor

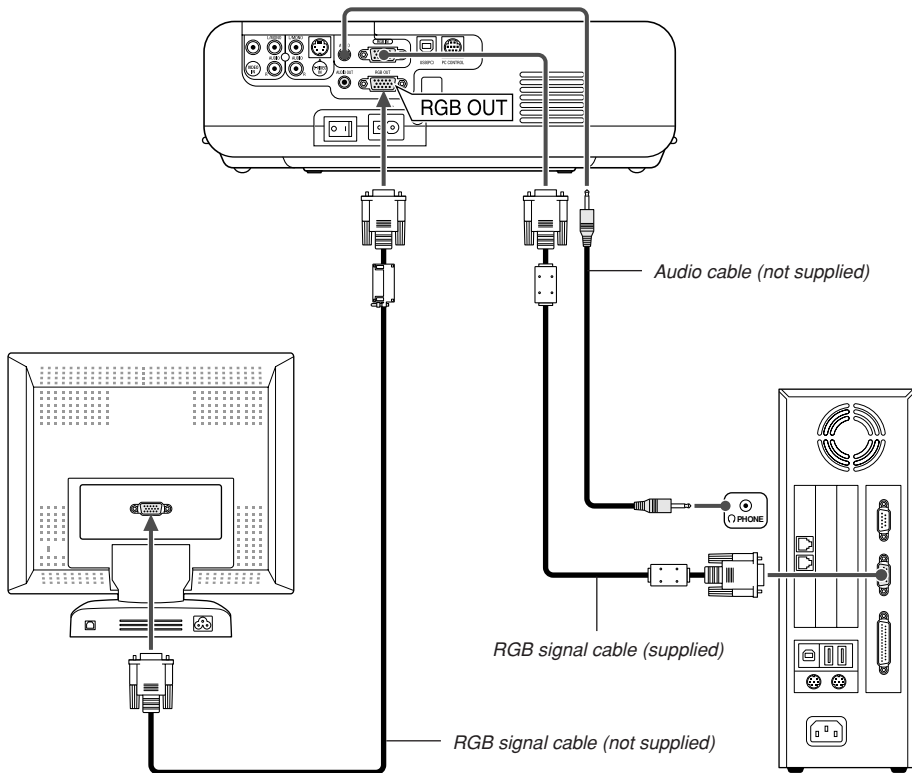

You can connect a separate, external monitor to your projector to simultaneously view on a monitor the RGB analog image you're projecting. To do so:

1. Turn off the power to your projector, monitor and computer.
2. Use a 15-pin cable to connect your monitor to the RGB OUT (Mini D-Sub 15 pin) connector on your projector.
3. Turn on the projector, monitor and the computer.

**NOTE:**

- The RGB OUT connector outputs RGB signal during standby mode. When the projector goes into standby mode, the image on an external monitor disappears for a moment.
- When the projector is in the standby mode, the image may not be correctly displayed while the cooling fans are running immediately after turning on or off the power.
- Daisy chain connection is not possible.

## Connecting Your DVD Player

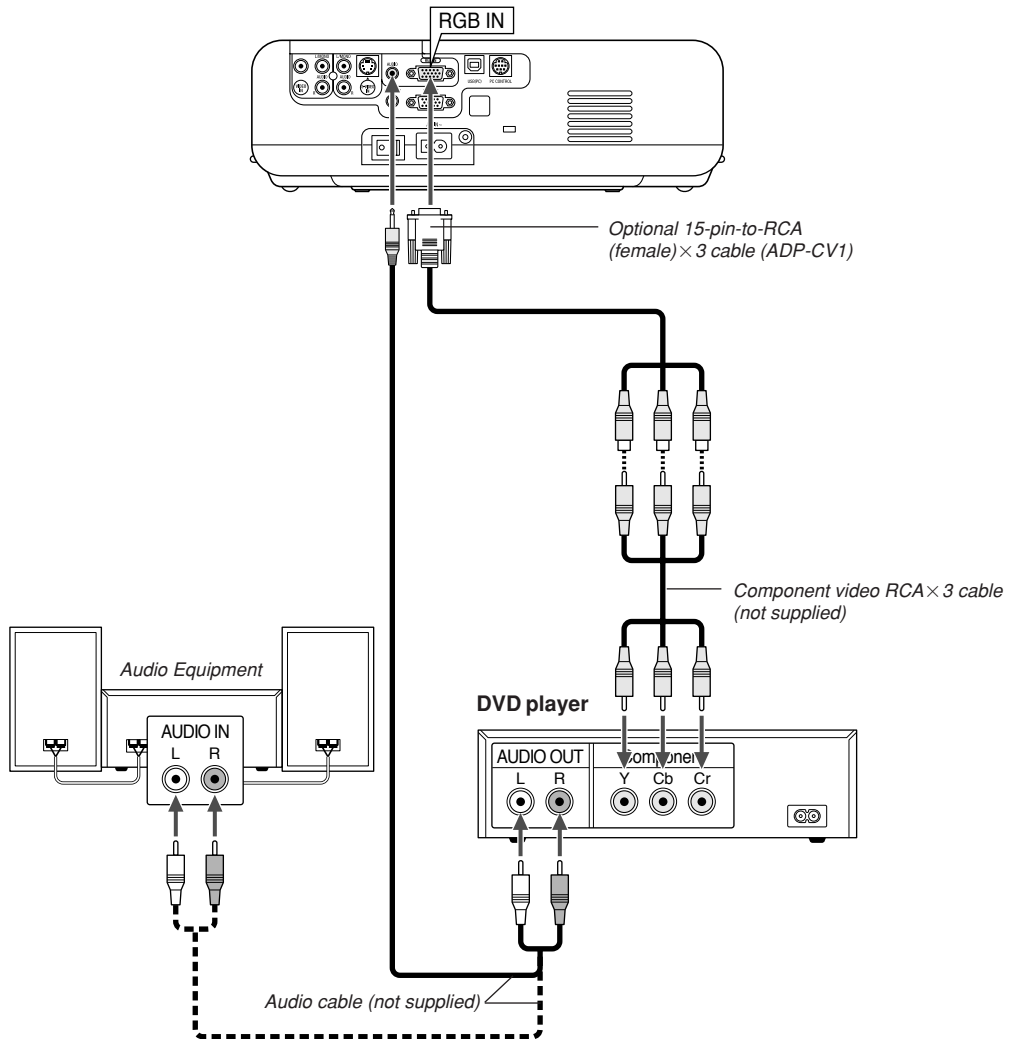

You can connect your projector to a DVD player with component output or Video output. To do so, simply:

1. Turn off the power to your projector and DVD player.
2. If your DVD player has the component video (Y,Cb,Cr) output, use a commercially available component video cable (RCA x 3) and the optional 15-pin-to-RCA (female) x 3 cable to connect your DVD player to the RGB IN connector on the projector.

For a DVD player without component video (Y,Cb,Cr) output, use common RCA cables (not provided) to connect a composite VIDEO output of the DVD player to the Video Input of the projector.

3. Turn on the projector and DVD player.

**NOTE:** Refer to your DVD player's owner's manual for more information about your DVD player's video output requirements.

## Connecting Your VCR or Laser Disc Player

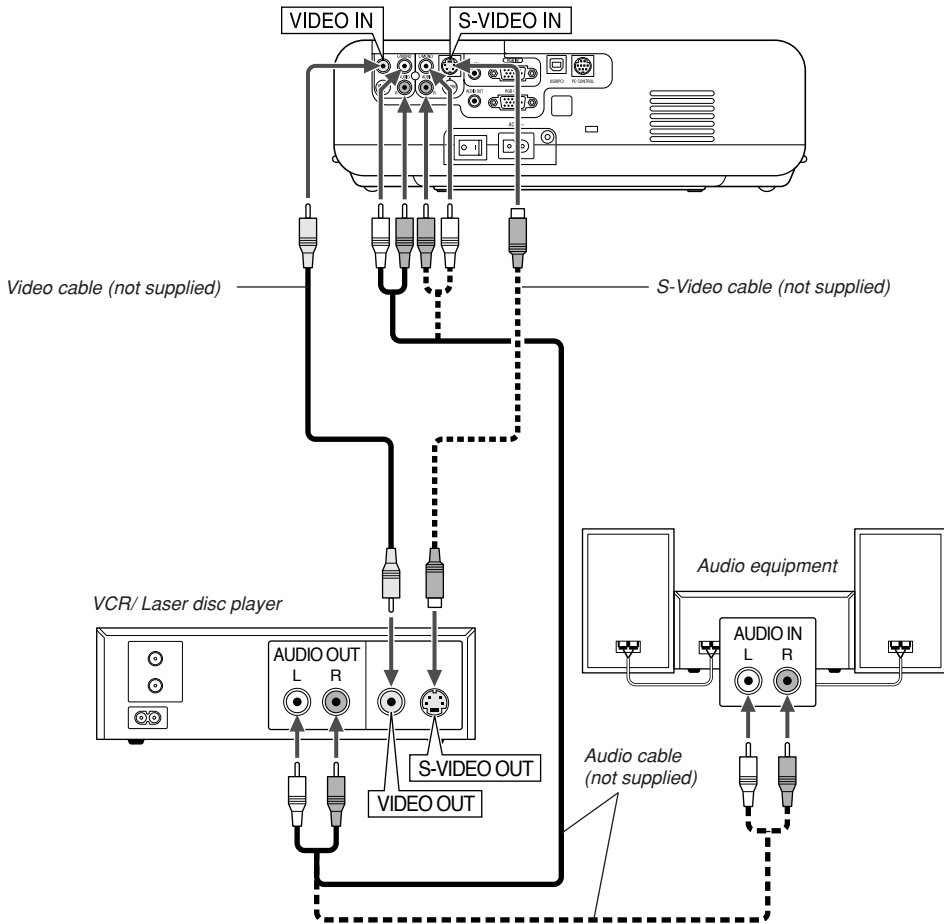

Use common RCA cables (not provided) to connect your VCR, laser disc player or document camera to your projector.

To make these connections, simply:

1. Turn off the power to the projector and VCR, laser disc player or document camera.
2. Connect one end of your RCA cable to the video output connector on the back of your VCR or laser disc player, connect the other end to the Video input on your projector. Use an audio cable (not supplied) to connect the audio from your VCR or laser disc player to your audio equipment (if your VCR or laser disc player has this capability). Be careful to keep your right and left channel connections correct for stereo sound.
3. Turn on the projector and the VCR or laser disc player.

**NOTE:** Refer to your VCR or laser disc player owner's manual for more information about your equipment's video output requirements.

**NOTE:** An image may not be displayed correctly when a Video or S-Video source is played back in fast-forward or fast-rewind via a scan converter.

## Connecting the Supplied Power Cable

Connect the supplied power cable to the projector. First connect the supplied power cable's two-pin plug to the AC IN of the projector, and then connect the other plug of the supplied power cable in the wall outlet.

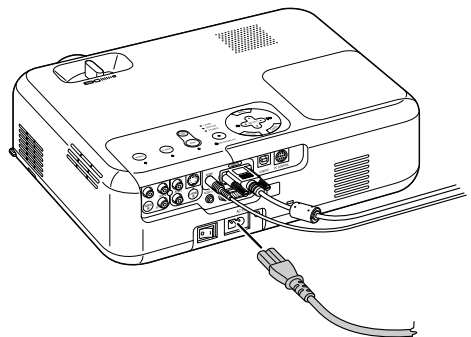



# PROJECTING AN IMAGE (BASIC OPERATION)

This section describes how to turn on the projector and to project a picture onto the screen.

## Turning on the Projector

### NOTE:

- The projector has two power switches: main power switch and POWER (ON/STAND BY) button (POWER ON and OFF on the remote control).
- When plugging in or unplugging the supplied power cable, make sure that the main power switch is pushed to the off (O) position. Failure to do so may cause damage to the projector.

To turn on the main power to the projector, press the Main Power switch to the on position ( I ).

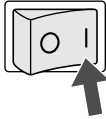

Before you turn on your projector, ensure that the computer or video source is turned on and that your lens cap is removed.

Only after you press the POWER (ON/STAND BY) button on the projector cabinet or POWER ON button on the remote control for a minimum of 2 seconds will the power indicator turn to green and the projector become ready to use.

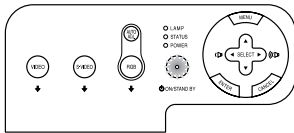

### Note on Startup screen (Menu Language Select screen)

When you first turn on the projector, you will get the Startup screen. This screen gives you the opportunity to select one of the 21 menu languages. To select a menu language, follow these steps:

1. Use the SELECT ▲ or ▼ button to select one of the 21 languages for the menu.

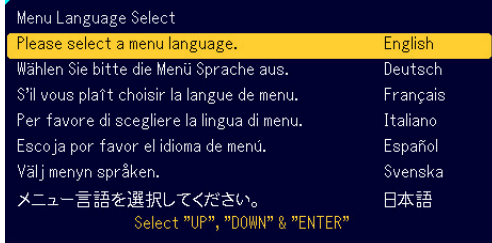
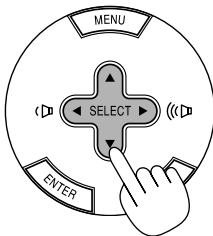

2. Press the ENTER button to execute the selection.

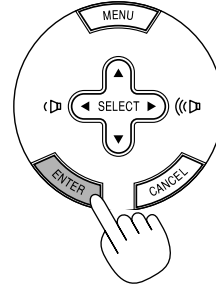

After this has been done, you can proceed to the menu operation. If you want, you can select the menu language later. See "Language" on page E-27.

**NOTE:** Immediately after turning on the projector, screen flicker may occur. This is not a fault. Wait 3 to 5 minutes until the lamp lighting is stabilized.

When the Lamp mode is set to Eco, the Lamp indicator will light green. If one of the following things happens, the projector will not turn on.

- \* If the internal temperature of the projector is too high, the projector detects abnormal high temperature. In this condition the projector will not turn on to protect the internal system. If this happens, wait for the projector's internal components to cool down.
- \* When the lamp reaches its end of usable life, the projector will not turn on. If this happens, replace the lamp.
- \* If the lamp fails to light, and if the STATUS indicator flashes on and off in a cycle of six times, wait a full minute and then turn on the power.

## Selecting a Source

### Selecting the computer or video source

Using the Remote Control

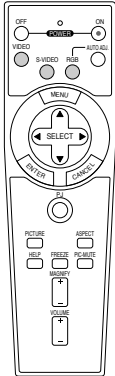

Press any one of the RGB, VIDEO or S-VIDEO buttons.

Using the cabinet buttons

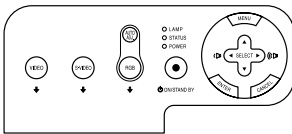

Press any one of the RGB, VIDEO or S-VIDEO buttons.

**NOTE:** If no input signal is available, the projector will display a blue background (factory preset).

## Adjusting the Picture Size and Position

Place your projector on a flat level surface and ensure that the projector is square to the screen.

Lift the front edge of the projector to center the image vertically.

\* If the projected image does not appear square to the screen then use the Keystone feature for proper adjustment. See page E-19.

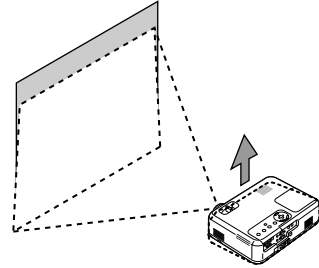

Move the projector left to center the image horizontally on the screen.

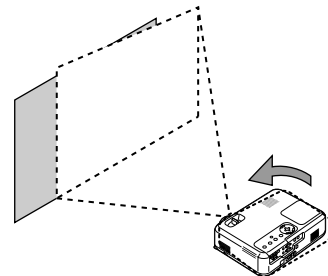

### Adjust the Tilt Foot

1. Lift the front edge of the projector.

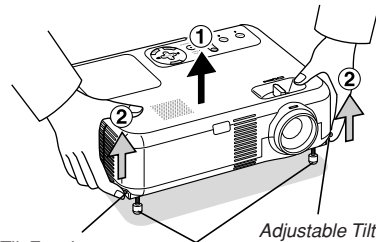

Adjustable Tilt Foot Lever

Adjustable Tilt Foot

2. Push up the Adjustable Tilt Foot Levers on the right and left sides of the projector to extend the adjustable tilt feet (maximum height).

3. Push down the Adjustable Tilt Foot Levers.

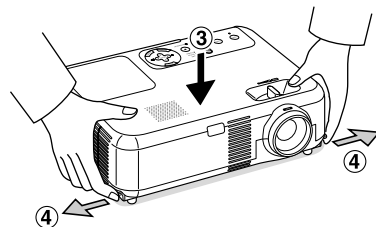

4. Lower the front of the projector to the desired height (max. 40mm/ 1.6") and release the Adjustable Tilt Foot Lever to lock the Adjustable tilt foot. There is approximately 10 degrees of up and down adjustment for the front of the projector.

### CAUTION

Do not use the tilt-foot for purposes other than originally intended. Misuses such as gripping the tilt-foot or hanging on the wall can cause damage to the projector.

### Zoom

Use the ZOOM lever to finely adjust the image size on the screen.

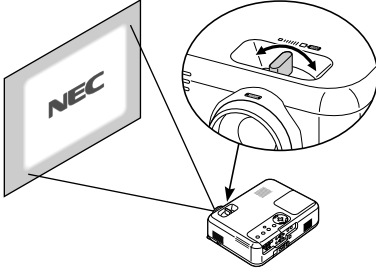

You can use the ZOOM lever to enlarge or reduce an image size.

### Focus

Use the FOCUS ring to obtain the best focus.

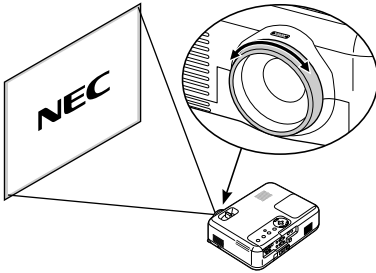

## Correcting the Vertical Keystone Distortion

### Auto Keystone Correction

The Auto Keystone correction feature will correct the vertical distortion of a projected image on the screen. No special operation required. Just put the projector on a flat surface.

Note that the vertical keystone angle can be corrected between 30 degrees upward and 30 degrees downward of projector tilt from level.



**NOTE:** Keystone correction angle could be less than 30 degrees for some signals that have a high resolution or frequency such as UXGA.

### Manual Keystone Correction

You can also correct the vertical keystone distortion manually. To do so:

1. Press the MENU button.  
The menu will be displayed.

2. Turn off the Auto Keystone function.

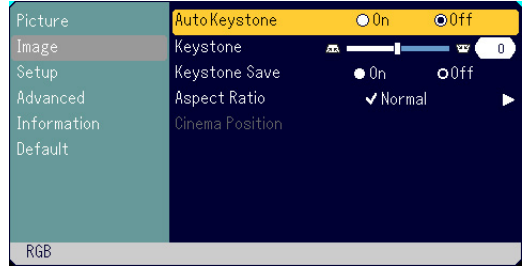

Use the SELECT ▼ button to select "Image" and then press the SELECT ► button. The "Auto Keystone" will be displayed. Press the SELECT ► to select "Off".

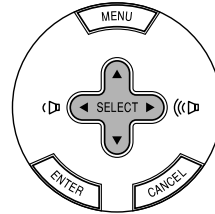

3. Select the Keystone function.

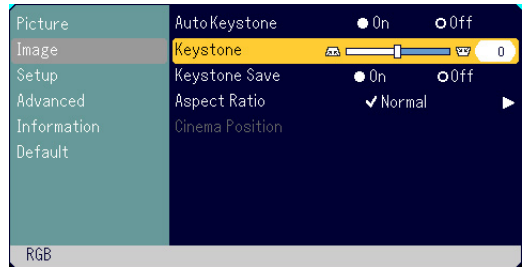

Use the SELECT ▼ button to select "Keystone".

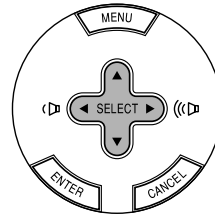

4. Correct the vertical distortion.

Use the SELECT ◀ or ▶ button to correct the vertical keystone distortion.

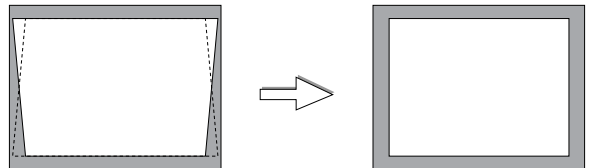

5. Press the MENU button to close the menu.

**NOTE:** You can save the changes using the Keystone Save feature when you turn off the projector.

## Optimizing RGB Picture Automatically

### Adjusting the Image Using Auto Adjust

Optimizing RGB image automatically

Press the Auto Adjust button to optimize an RGB image automatically.

[Poor picture]

AUTO ADJ.

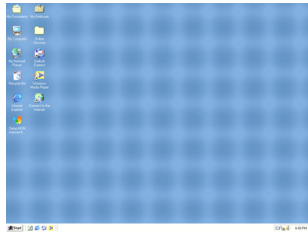

[Normal picture]

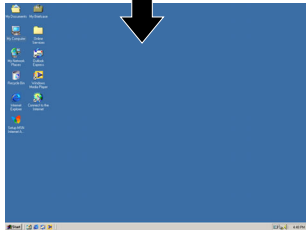

Press the Auto Adjust button to fine-tune the computer image or to remove any vertical banding that might appear and to reduce video noise, dot interference or cross talk (this is evident when part of your image appears to be shimmering). This function adjusts the clock frequencies that eliminate the horizontal banding in the image. This function also adjusts the clock phase to reduce video noise, dot interference or cross talk. (This is evident when part of your image appears to be shimmering.)

This adjustment may be necessary when you connect your computer for the first time.

#### NOTE:

- Some signals may not be displayed correctly or take time.
- The Auto Adjust function does not work for component and video signal.
- If the Auto Adjust operation cannot optimize the RGB signal, try to adjust Clock and Phase manually. See page E-29.

## Turning Up or Down Volume

Sound level from the speaker and the AUDIO OUT jack (Stereo mini) on the projector can be adjusted.

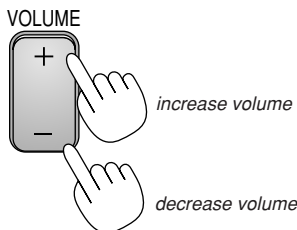

## Turning off the Projector

### To turn off the projector:

First, press the POWER (ON/STAND BY) button on the projector cabinet or the POWER OFF button on the remote control. The "Power Off / Are you sure?" message will appear.

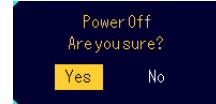
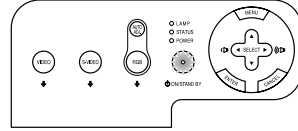

Secondly, press the ENTER button or press the POWER (ON/STAND BY) or the POWER OFF button again.

The power indicator will glow orange. After the projector turns off, the cooling fans keep operating for 60 seconds (Cooling-off time).

Lastly, turn off the Main Power switch. The power indicator will go out. Last unplug the power cable.

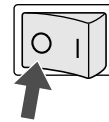

#### CAUTION

Do not unplug the power cable from the wall outlet or do not turn off the main power under any one of the following circumstances. Doing so can cause damage to the projector:

- While the Hour Glass icon appears.
- While the cooling fans are running. (The cooling fans continue to work for 60 seconds after the projector is turned off).

# CONVENIENT FEATURES

## Using the Remote Mouse Function

The built-in remote mouse function enables you to operate your computer's mouse functions from the remote control (Computer mode). It is a great convenience for clicking through your computer-generated presentations. To return to the projector operation mode (Projector mode), press the PJ button (lit red).

### Connecting to your computer for the remote mouse function

If you wish to use the remote mouse function, use the supplied USB cable to connect the USB port (PC) of the projector and the USB port (type A) of your computer.

**NOTE:** Depending on the type of connection or OS installed on your computer, you may have to restart your computer or change your computer settings.

## When using the USB Port

The remote mouse function can only be used with a Windows 98, Windows Me, Windows XP, Windows 2000 or Mac OS operating system.

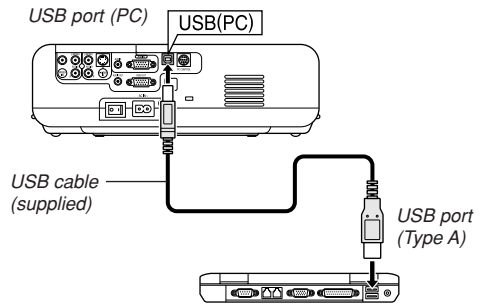

**NOTE:** Wait at least 5 seconds after disconnecting the USB cable before reconnecting it and vice versa. The computer may not identify the built-in mouse receiver if it is repeatedly connected and disconnected in rapid intervals.

## Switching operation mode between computer and projector

The three shaded buttons shown on the drawing as a computer mouse in the Computer mode. In the Computer mode the PJ button is not lit.

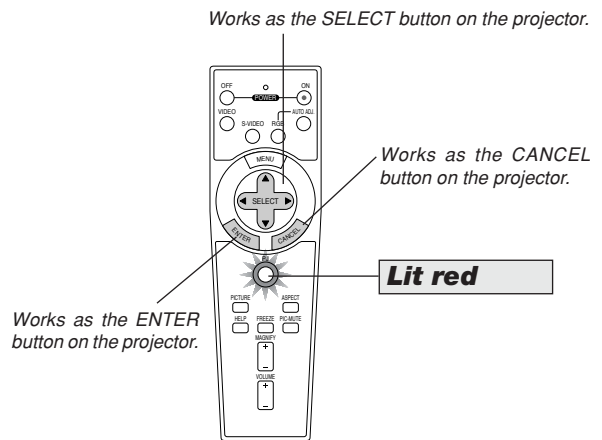
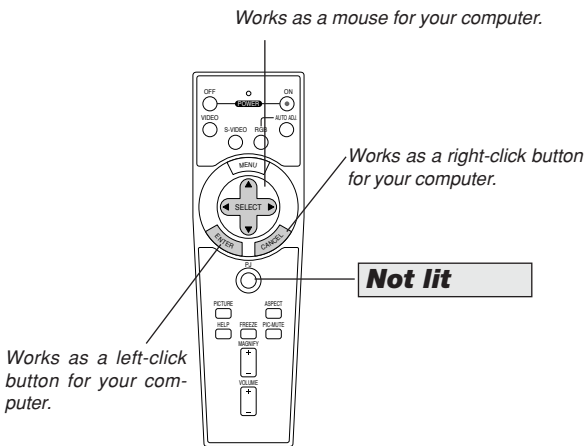

- When the MENU button is pressed, the PJ button lights red to indicate that you are in the Projector mode, which allows the projector menu operation using the three buttons.
- If no buttons are pressed within 60 seconds, the PJ button's light goes out to indicate that you are in the Computer mode. To enable the projector menu operation again, press the PJ button to light red.
- When the PJ button is lit, if you want to use the mouse function immediately, press the PJ button to return to the Computer mode (not lit).

### During Computer mode:

In Computer mode, by pressing the ENTER button for 2 seconds or more then releasing, the drag mode is set and the drag operation can be performed simply by pressing the SELECT ▲▼◀▶ (mouse) button. To drop the item, press the ENTER (left click) button again or press the CANCEL (right click) button.

## Turning off the Image and Sound

Press the PIC-MUTE button to turn off the image and sound for a short period of time. Press again to restore the image and sound.

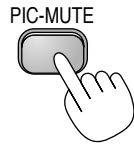

## Freezing a Picture

Press the FREEZE button to freeze a picture. Press again to resume motion.



## Enlarging and Moving a Picture

You can enlarge the picture up to 400 percent.  
To do so:

1. Press the MAGNIFY (+) button to magnify the picture.  
To move the magnified image, use the SELECT button.

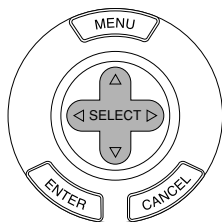
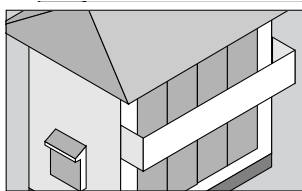
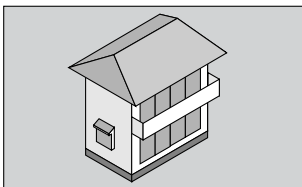

2. Return the image to the original size.

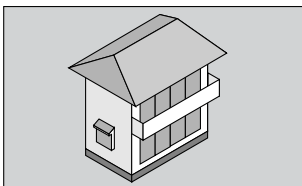

## Getting the Information

You get the information about the signal and projector settings.



Display Information

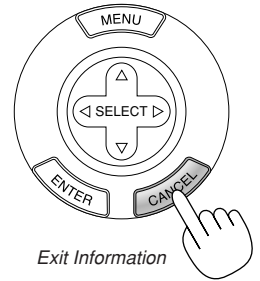

Exit Information

# USING ON-SCREEN MENU

## Basic Menu Operation

### Using the Menus

**NOTE:** The on-screen menu may not be displayed correctly while interlaced motion video image is projected.

1. Press the MENU button on the remote control or projector cabinet to display the Menu.

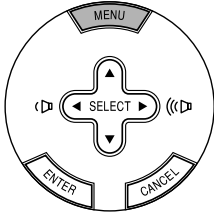

2. Press the SELECT ▲▼ buttons on the remote control or the projector cabinet to highlight the menu for the item you want to adjust or set.

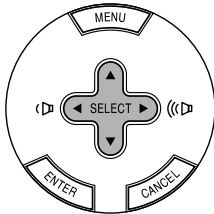

3. Press the SELECT ► button or the ENTER button on the remote control or the projector cabinet to select a submenu or item.

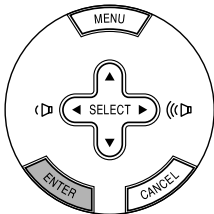

4. Adjust the level or turn the selected item on or off by using SELECT ◀ or ▶ buttons on the remote control or the projector cabinet.

The on-screen slide bar will show you the amount of increase or decrease.

5. Changes are stored until you adjust it again.

CANCEL ..... Return to the previous screen.

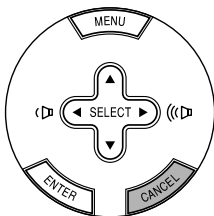

6. Repeat steps 2-5 to adjust an additional item, or press the MENU button to close the menu.

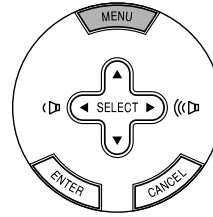

## List of Menu Items

<b>Picture</b>	
Brightness	
Contrast	
Sharpness	
Color	
Hue	
Picture Management	Presentation, Video, Movie, Graphic, sRGB
	User
	Base Setting                      Presentation, Video, Movie, Graphic, sRGB
	White Balance                    Brightness R,G,B Contrast R,G,B
	Gamma Correction                Dynamic, Black Detail, Natural
<b>Image</b>	
Auto Keystone	On, Off
Keystone	
Keystone Save	On, Off
Aspect Ratio	Normal, Wide Zoom, Cinema, Native
Cinema Position	
<b>Setup</b>	
Lamp Mode	Normal, Eco
Language	Language-1 English, Deutsch, Français, Italiano, Español, Português, Nederlands
	Language-2 Svenska, Norsk, Suomi, Český, Magyar, Polski, Türkçe
	Language-3 Русский, Ελληνικά, 日本語, 中文, 한국어, العربية, Dansk
Menu Color Select	Color, Monochrome
Menu Display Time	Manual, Auto 5 sec, Auto 15sec, Auto 45 sec
Background	Blue, Black, Logo
Orientation	Desktop Front, Ceiling Rear, Desktop Rear, Ceiling Front
<b>Advanced</b>	
Security	On, Off
Control Panel Key Lock	Enable, Disable
High Speed Fan Mode	On, Off
Signal Select RGB	RGB/Component, RGB, Component, Scart
Video	Auto, NTSC3.58, NTSC4.43, PAL, PAL-M, PAL-N, PAL60, SECAM
S-Video	Auto, NTSC3.58, NTSC4.43, PAL, PAL-M, PAL-N, PAL60, SECAM
Page2	Power Management    On, Off
	Noise reduction        Off, Low, High
	Auto Adjust            On, Off
	Horizontal
	Vertical
	Clock
	Phase
	Communication Speed 4800, 9600, 19200
<b>Information</b>	
Page1	Source Index, Horizontal Frequency, Vertical Frequency, Sync Polarity
Page2	Signal Type, Video Type, Sync Type, Interlace
Page3	Remaining Lamp Time, Lamp Hour Meter, Filter Usage, Projector Usage
<b>Default</b>	
Factory Default	Current Signal
	All Data
Clear Filter Usage	
Clear Lamp Hour Meter	

**NOTE:** Some menu items are not available depending on the input source.



## Menu Elements

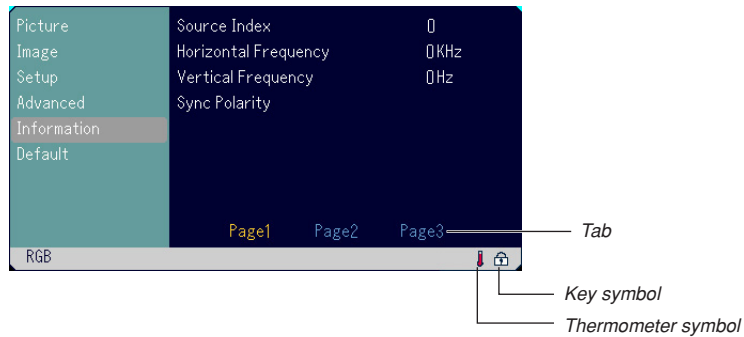
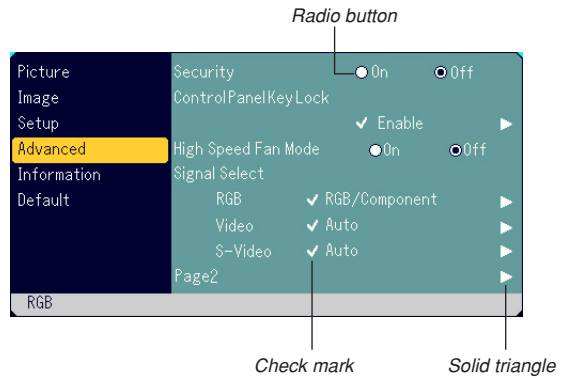
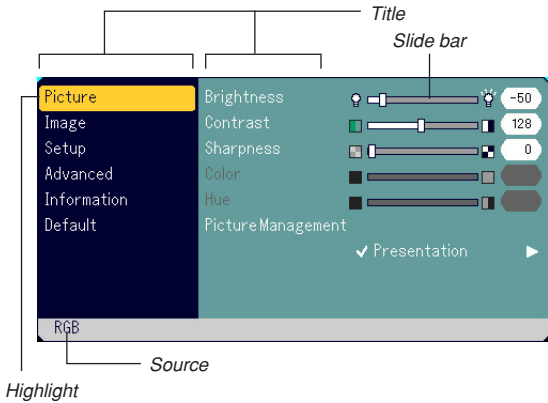

Menu windows or dialog boxes typically have the following elements:

- Title ..... Indicates the menu title.
- Highlight ..... Indicates the selected menu or item.
- Source ..... Indicates the currently selected source.
- Solid triangle ..... Indicates further choices are available. A highlighted triangle indicates the item is active.
- Tab ..... Indicates a group of features in a dialog box. Selecting on any tab brings its page to the front.
- Radio button ..... Use this round button to select an option in a dialog box.
- Check mark ..... Indicates the item is selected.
- Slide bar ..... Indicates settings or the direction of adjustment.
- Key symbol ..... Indicates the Control Panel Key Lock is enabled.
- Thermometer symbol ... Indicates the lamp mode is forcibly set to Eco mode because the internal temperature is too high.

## Menu Descriptions & Functions

### Picture

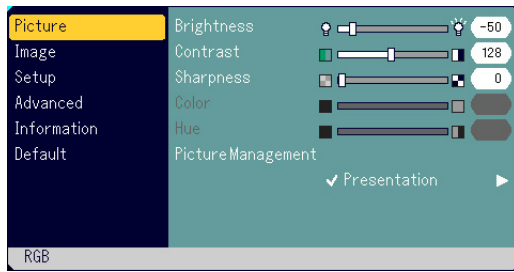

Adjusting Brightness, Contrast, Sharpness, Color, Hue and Picture Management.

- Brightness ..... Adjusts the brightness level or the back raster intensity.
- Contrast ..... Adjusts the intensity of the image according to the incoming signal.
- Sharpness ..... Controls the detail of the image for Video.
- Color ..... Increases or decreases the color saturation level (not valid for RGB).
- Hue ..... Varies the color level from +/- green to +/-blue. The red level is used as reference. This adjustment is only valid for Video and Component inputs (not valid for RGB).

### Picture Management

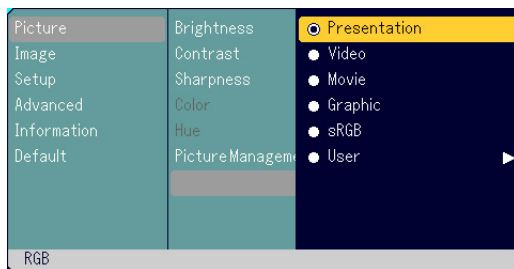

This option allows you to adjust neutral tint for yellow, cyan or magenta. There are 5 factory presets optimized for various types of images, or you can set user adjustable settings.

- Presentation .. Recommended for making a presentation using a PowerPoint file
- Video ..... Recommended for regular picture such as TV program
- Movie ..... Recommended for movie
- Graphic ..... Recommended for graphics
- sRGB ..... Standard color values
- User ..... User adjustable

**NOTE:** When "sRGB", "Graphic", "Video" or "Movie" is selected, the brightness decreases slightly when compared to "Presentation". This is not a malfunction.

### User Adjust (when using User )

When selecting user adjustable presetting (User), the submenu will be displayed.

You can customize each gamma or color. To do so, first select "User" and press the ENTER button, and then proceed the following steps.

### Selecting Base Setting <Base Setting>

This feature allows you to use white balance or gamma values as reference data to optimize for various types of images. You can select one of the following five settings.

- Presentation
- Video
- Movie
- Graphic
- sRGB

### Adjusting White Balance <White Balance>

This allows you to adjust the white balance. Brightness for each color (RGB) is used to adjust the black level of the screen; Contrast for each color (RGB) to adjust the white level of the screen.

### Selecting Gamma Correction Mode <Gamma Correction>

Each mode is recommended for :

Dynamic ..... For true color reproduction of natural tones

Black Detail .... For dark portions of a picture

Natural ..... Normal settings

### Image

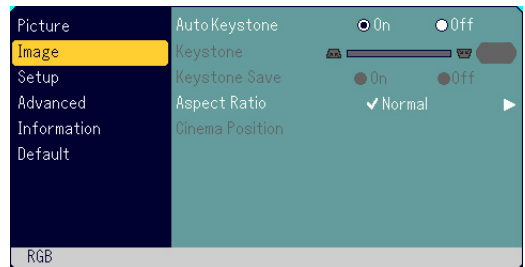

### Enabling Auto Keystone [Auto Keystone]

This feature allows the projector to detect its tilt and correct vertical distortion automatically.

To turn on the Auto Keystone feature, select "On".

### Correcting Vertical Keystone Distortion Manually [Keystone]

You can correct vertical distortion manually from the menu.

You can save the changes using the Keystone Save feature when you turn off the projector.

### Saving Vertical Keystone Correction [Keystone Save]

This option enables you to save your current keystone settings.

Saving your change once affects all sources. The changes are saved when the projector is off.

### Selecting Aspect Ratio [Aspect Ratio]

Aspect Ratio allows you to select the best Aspect mode to display your source image. You can also display the Aspect Ratio window by pressing the "ASPECT" button on the remote control. (See page E-9). When 4:3 is selected from the source (i.e. DVD player), the following selections will display:

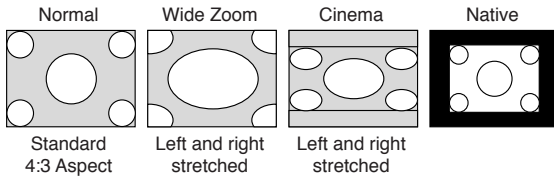

When 16:9 is selected from the source (i.e. DVD player), the following selections will display:

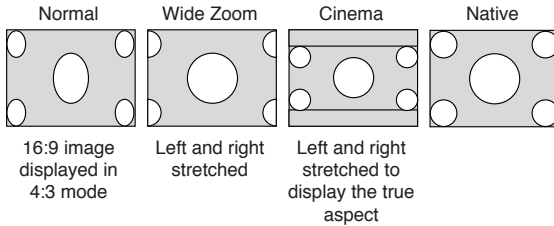

Native (RGB only): Turns off the Advanced AccuBlend feature. The projector displays the current image in its true resolution.

#### NOTE:

\* While you are displaying an image with higher resolution than the projector's native resolution, "Native" is not available.

\* You can adjust image positions for Cinema. See "Cinema Position" for setting image positions.

#### Copyright

Please note that using this projector for the purpose of commercial gain or the attraction of public attention in a venue such as a coffee shop or hotel and employing compression or expansion of the screen image with a "Aspect Ratio" setting may raise concern about the infringement of copyrights which are protected by copyright law.

### Adjusting the Vertical Position of Image [Cinema Position] (for Cinema only)

This feature adjusts the vertical position of the image when viewing video with an aspect ratio selected.

When "Cinema" is selected in "Aspect Ratio", the image is displayed with black borders on the top and bottom.

You can adjust the vertical position between top and bottom.

**NOTE:** This option is available only when "Cinema" is selected in Aspect Ratio.

### Setup

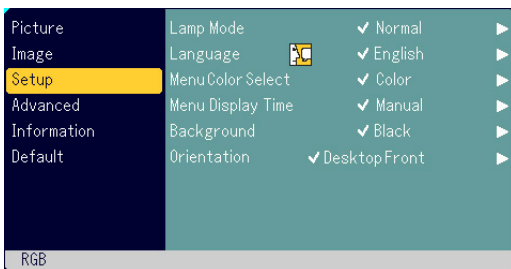

### Selecting Lamp Mode [Lamp Mode]

This feature enables you to select two brightness modes of the lamp: Normal and Eco modes. The lamp life can be extended by using the Eco mode.

Normal Mode ... This is the default setting (100% Brightness).

Eco Mode ..... Select this mode to increase the lamp life (80% Brightness).

**NOTE:** Thermometer symbol  indicates the lamp mode is forcibly set to Eco mode because the internal temperature is too high.

### Selecting Menu Language [Language]

You can choose one of 21 languages for on-screen instructions.

### Selecting Menu Color [Menu Color Select]

You can choose between two color modes for menu color: color and monochrome.

### Selecting Menu Display Time [Menu Display Time]

This option allows you to select how long the projector waits after the last touch of a button to turn off the menu.

The preset choices are "Manual", "Auto 5 sec", "Auto 15 sec", and "Auto 45 sec". The "Auto 45 sec" is the factory preset.

### Selecting a Color or Logo for Background [Background]

Use this feature to display a black/ blue screen or logo when no signal is available.

### Selecting Projector Orientation [Orientation]

This sets your image for your type of projection. The options are: desktop front projection, ceiling rear projection, desktop rear projection, and ceiling front projection.

### Advanced

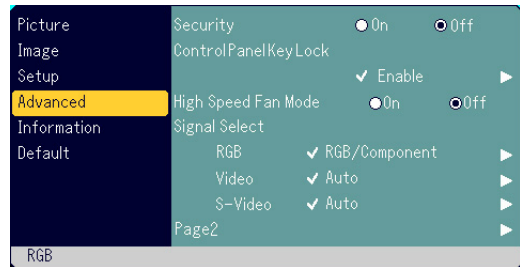

### Security

A keyword can be set for your projector to avoid operation by an unauthorized user using the Menu. When a keyword is set, turning on the projector will display the Keyword input screen. Unless the correct keyword is entered, the projector cannot project an image.

### To enable the Security function:

1. Select [Advanced] → [Security] and press the ◀ button to select "On".

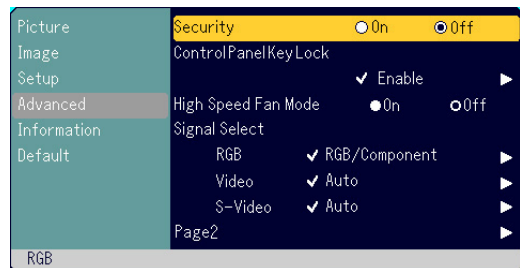

The [Keyword] screen will be displayed.

- Type in a combination of the four SELECT buttons ( ▲▼◀▶ ) and press the ENTER button.

**NOTE:** A keyword must be four to 10 digits in length.

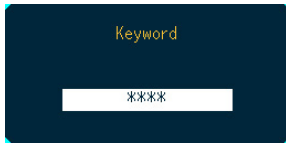

The [Confirm Keyword] screen will be displayed.



- Type in the same combination of SELECT buttons ( ▲▼◀▶ ) and press the ENTER button. The confirmation screen will be displayed.

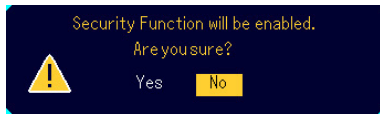

- Select "Yes" and press the ENTER button. The Security function has been enabled.

**To disable the Security function:**

- Select [Advanced] → [Security] and press the ► button to select "Off".

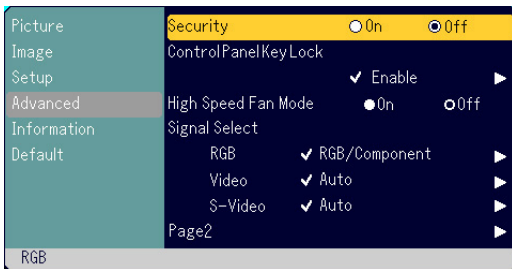

The Keyword confirmation screen will be displayed.

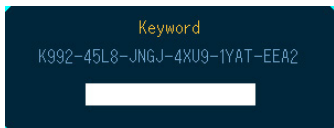

- Type in your keyword and press the ENTER button. When the correct keyword is entered, the Security function will be disabled.

**When the Security function is enabled and the projector is turned on, the projector will display a blue background.**

To display an image at this time, press the MENU button to display the Keyword input screen.

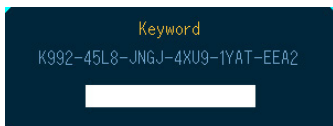

Type in the correct keyword. The projector will display an image.

**NOTE:**

- \* The security disable mode is maintained until the main power is turned off (by setting the main power switch to "0" or unplugging the power cable).
- \* If you forget your keyword, contact your dealer. Your dealer will provide you with your keyword in exchange for your request code. Your request code is displayed in the Keyword Confirmation screen. In this example "K992-45L8-JNGJ-4XU9-1YAT-EEA2" is a request code.

**Disabling the Cabinet Buttons [Control Panel Key Lock]**

This option turns on or off the Control Panel Key Lock function.

**NOTE:**

- \* This Control Panel Key Lock does not affect the remote control and the PC Control functions.
- \* When the cabinet buttons are disabled, pressing and holding the CANCEL button for about 10 seconds will change the setting to enable.
- \* Key symbol  indicates the Control Panel Key Lock is enabled.

**Enabling High Speed Fan Mode [High Speed Fan Mode]**

This option allows you to select two modes for fan speed: high-speed mode and normal speed mode.

When you wish to cool down the temperature inside the projector quickly, select "On".

**NOTE:** Enable High Speed Fan mode if you continue to use the projector for consecutive days.

**Selecting Signal Format [Signal Select]**

<RGB>

Allows you to choose "RGB" for an RGB source such as a computer, or "Component" for a component video source such as a DVD player. Normally select "RGB/Component" and the projector automatically detects a component signal. However there may be some component signals that the projector is unable to detect. If this is the case, select "Component". Select "Scart" for the European Scart.

<Video & S-Video System Select>

This feature enables you to select composite video standards manually. Normally select "Auto". When you select the video standard for Video and S-Video, select the video standard from the pull-down menu. This must be done for Video and S-Video respectively.

**Page2**

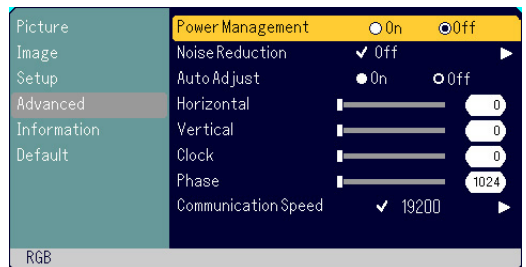

**Enabling Power Management [Power Management]**

When this option is on and there is no input for five minutes or more, the projector will automatically turn itself off.

**Selecting Noise Reduction Level [Noise Reduction]**

Select one of the three levels for reducing video noise: Off, Low, or High.

**NOTE:** The lower the Noise Reduction level, the better the image quality by way of higher video bandwidth.

**Enabling Auto Adjust [Auto Adjust]**

When "Auto Adjust" is set to "On", the projector automatically determines the best resolution for the current RGB input signal to project an image using NEC's Advanced AccuBlend Intelligent Pixel Blending Technology.

The image can be automatically adjusted for position and stability; "Horizontal Position", "Vertical Position", "Clock" and "Phase".

On ..... Automatically adjusts image "Horizontal Position", "Vertical Position", "Clock" and "Phase".

Off ..... User can adjust the image display functions ("Horizontal Position", "Vertical Position", "Clock" and "Phase") manually.

**Adjusting Position/Clock (when Auto Adjust is off)**

This allows you to manually adjust the image horizontally and vertically, and adjust Clock and Phase.

<Horizontal/Vertical>

Adjusts the image location horizontally and vertically.

This adjustment is made automatically when the Auto Adjust is turned on.

<Clock>

Use this item with the "Auto Adjust off" to fine tune the computer image or to remove any vertical banding that might appear. This function adjusts the clock frequencies that eliminate the horizontal banding in the image. This adjustment may be necessary when you connect your computer for the first time. This adjustment is made automatically when the Auto Adjust is turned on.

<Phase>

Use this item to adjust the clock phase or to reduce video noise, dot interference or cross talk. (This is evident when part of your image appears to be shimmering.)

Use "Phase" only after the "Clock" is complete.

This adjustment is made automatically when the Auto Adjust is turned on.

**Selecting Communication Speed [Communication Speed]**

This feature sets the baud rate of the PC Control port (DIN 8 Pin). It supports data rates from 4800 to 19200 bps.

The default is 19200 bps.

Select the appropriate baud rate for your equipment to be connected (depending on the equipment, a lower baud rate may be recommended for long cable runs).

**Information**

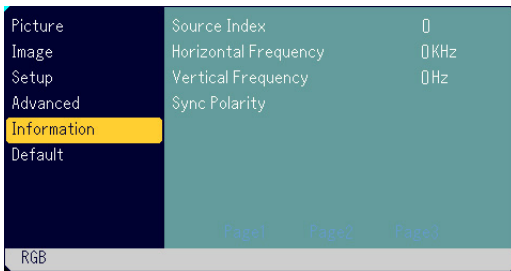

Displays the status of the current signal and lamp usage. This item has three pages. The information included is as follows:

[Page 1]  
Source Index  
Horizontal Frequency  
Vertical Frequency  
Sync Polarity

[Page 2]  
Signal Type  
Video Type  
Sync Type  
Interface

[Page 3]  
Remaining Lamp Time (%)\*  
Lamp Hour Meter (H)  
Filter Usage  
Projector Usage

\* The progress indicator shows the percentage of remaining bulb life. The value informs you of the amount of lamp usage. When the remaining lamp time reaches 0, the Remaining Lamp Time bar indicator changes from 0% to 100 Hours and starts counting down. If the remaining lamp time reaches 0 hours, the projector will not turn on regardless of whether the lamp mode is set to Normal or Eco.

**Default**

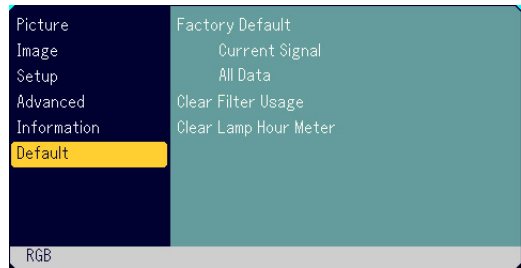

**Returning to Factory Default [Factory Default]**

The Factory Default feature allows you to change adjustments and setting to the factory preset for source except the following:

<Current Signal>

Resets the adjustments for the current signal to the factory preset levels.

The items that can be reset are: Brightness, Contrast, Color, Hue, Sharpness, Aspect Ratio, Horizontal Position, Vertical Position, Clock, Phase and Picture Management.

<All Data>

Reset all the adjustments and settings for all the signals to the factory preset.

The items can be reset except Language, Security, Communication Speed, Remaining Lamp Time, Lamp Hour Meter, Filter Usage and Projector Usage. To reset the lamp usage time, see "Clear Lamp Hour Meter" and "Clear Filter Usage".

**Resetting the Filter Usage Hours [Clear Filter Usage]**

Resets the filter usage back to zero. Selecting this option displays submenu for a confirmation.

**Clearing Lamp Hour Meter [Clear Lamp Hour Meter]**

Resets the lamp clock back to zero. Selecting this option displays submenu for a confirmation.

**NOTE:** The projector will turn off and go into standby mode after 2100 hours (up to 3100 hours in Eco mode) of service. If this happens, press the "Help" button on the remote control for ten seconds to reset the lamp clock back to zero. Do this only after replacing the lamp.

# MAINTENANCE

This section describes the simple maintenance procedures you should follow to replace the lamp and clean the filter.

## Replacing the Lamp

After your lamp has been operating for 2000 hours (up to 3000 hours in Eco mode) or longer, the LAMP indicator in the cabinet will blink red and the message will appear. Even though the lamp may still be working, replace it at 2000 (up to 3000 hours in Eco mode) hours to maintain optimal projector performance.

### CAUTION

- **DO NOT TOUCH THE LAMP** immediately after it has been used. It will be extremely hot. Turn the projector off, wait 60 seconds, turn off the main power switch and then disconnect the power cable. Allow at least one hour for the lamp to cool before handling.
- **DO NOT REMOVE ANY SCREWS** except the lamp cover screw and two lamp case screws. You could receive an electric shock.
- The projector will turn off and go into stand by mode after 2100 (up to 3100 hours in Eco mode) hours of service. If this happens, be sure to replace the lamp. If you continue to use the lamp after 2000 hours (up to 3000 hours in Eco mode) of use, the lamp bulb may shatter, and pieces of glass may be scattered in the lamp case. Do not touch them as the pieces of glass may cause injury. If this happens, contact your NEC dealer for lamp replacement.

### To replace the lamp:

1. Loosen the lamp cover screw until the screwdriver goes into a free-wheeling condition and remove the lamp cover. The lamp cover screw is not removable.

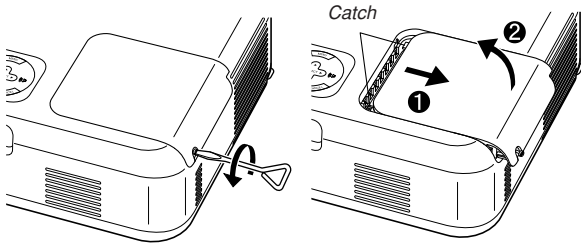

2. Loosen the two screws securing the lamp housing until the screwdriver goes into a freewheeling condition. The two screws are not removable.

Remove the lamp housing by holding it.

**NOTE:** There is an interlock on this case to prevent the risk of electrical shock. Do not attempt to circumvent this interlock.

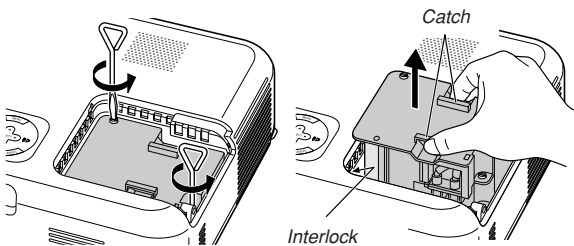

3. Insert a new lamp housing until the lamp housing is plugged into the socket.

### CAUTION

Do not use a lamp other than the NEC replacement lamp (VT60LP). Order this from your NEC dealer.

Secure it in place with the two screws.  
Be sure to tighten the screws.

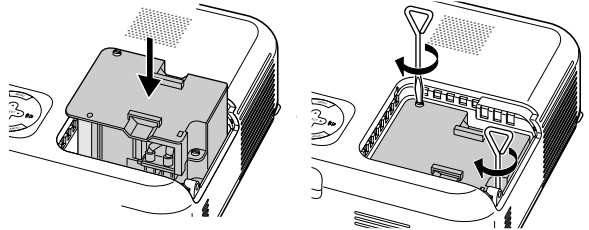

4. Reattach the lamp cover.

Tighten the lamp cover screw.  
Be sure to tighten the screw.

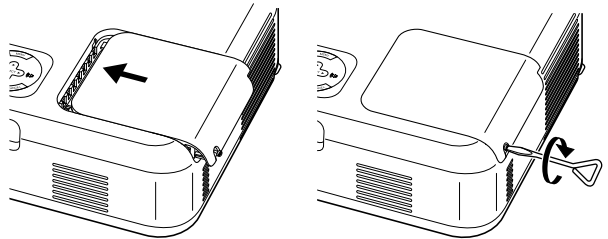

5. After you install a new lamp, select the menu → [Default] → [Clear Lamp Hour Meter] to reset the lamp usage hours.

**NOTE:** When the lamp exceeds 2100 hours (up to 3100 hours in Eco mode) of service, the projector cannot turn on and the menu is not displayed. If this happens, press the Help button on the remote control for a minimum of 10 seconds while in standby mode. When the lamp time clock is reset to zero, the LAMP indicator goes out.

## Cleaning

### Cleaning or Replacing the Filter

The air-filter sponge keeps the inside of the projector from dust or dirt and should be cleaned after every 100 hours of operation (more often in dusty conditions). If the filter is dirty or clogged, your projector may over-heat.

#### CAUTION

- Turn off the projector, turn off the main power switch and unplug the projector before replacing the filter.
- Only clean the outside of the filter cover with a vacuum cleaner.
- Do not attempt to operate the projector without the filter cover.

#### To clean the air-filter:

Vacuum the filter-through the filter cover.

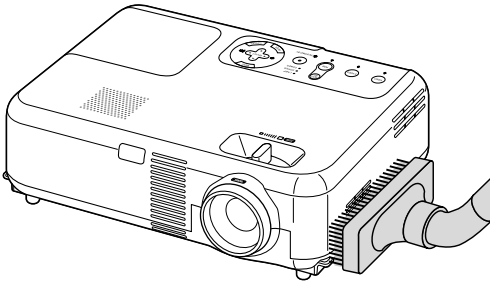

To reset the filter usage time, from the menu, select [Default] → [Clear Filter Usage].

See also page E-29 for resetting the filter usage time.

#### To replace the filter (sponge):

1. Remove the filter cover by pushing up on the catch of the cover until you feel it detach.

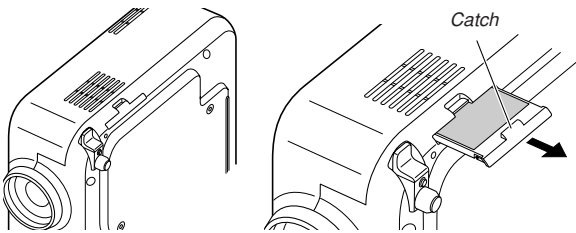

2. Gently peel off the filter (sponge) and replace it with the new one.

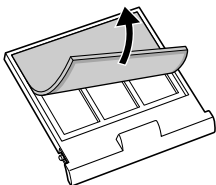

3. Reinstall the new filter cover.

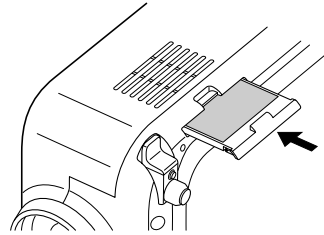

**NOTE:** Do not wash the filter with soap and water. Soap and water will damage the filter membrane. Before replacing the filter, remove dust and dirt from the projector cabinet. Keep out dust and dirt during filter replacement.

**NOTE:** When you replace the lamp, it is also wise to replace the filter. The filter comes in the same package with your replacement lamp.

### Cleaning the Cabinet and the Lens

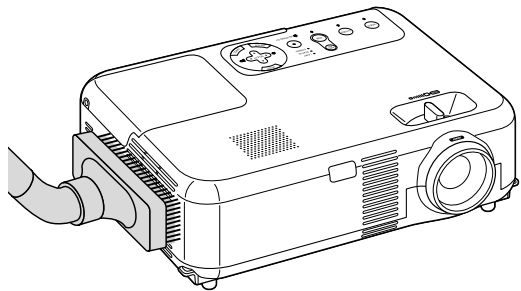

1. Turn off the projector before cleaning.
2. Clean the cabinet periodically with a damp cloth. If heavily soiled, use a mild detergent. Never use strong detergents or solvents such as alcohol or thinner.
3. Use a blower or lens paper to clean the lens, and be careful not to scratch or mar the lens.

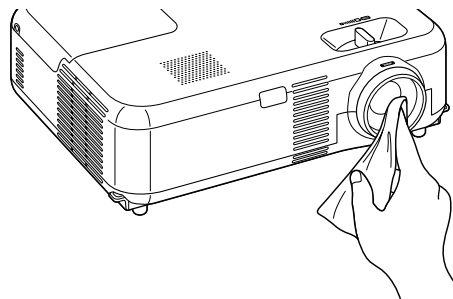

# TROUBLESHOOTING

This section helps you resolve problems you may encounter while setting up or using the projector.

## Power Indicator

Indicator Condition			Projector Condition	Note
Off			The main power is off.	–
Blinking light	Green	0.5 sec On, 0.5 sec Off	The projector is getting ready to turn on.	Wait for a moment.
	Orange	0.5 sec On, 0.5 sec Off	The projector is cooling down.	Wait for a moment.
Steady light	Green		The projector is turned on.	–
	Orange		The projector is in Standby.	–

## Status Indicator

Indicator Condition			Projector Condition	Note
Off			Normal	–
Blinking light	Red	1 cycle (0.5 sec On, 2.5 sec Off)	Lamp cover error or lamp housing error	Replace the lamp cover or lamp housing correctly.
		2 cycle (0.5 sec On, 0.5 sec Off)	Temperature error	The projector is overheated. Move the projector to a cooler location.
		4 cycle (0.5 sec On, 0.5 sec Off)	Fan error	Fans will not work correctly.
		6 cycle (0.5 sec On, 0.5 sec Off)	Lamp error	Lamp fails to light. Wait a full minute and then turn on again.
	Green		Re-firing the lamp	The projector is re-firing.
Steady light	Orange		Control Panel key locked	You have pressed control panel key when Control Panel Key Lock is enabled.

## Lamp Indicator

Indicator Condition			Projector Condition	Note
Off			Normal	–
Blinking light	Red		Lamp has reached its end of life. Lamp replacement message will be displayed.	Replace the lamp.
Steady light	Red		Lamp has been used beyond its limit. The projector will not turn on until the lamp is replaced.	Replace the lamp.
	Green		Lamp mode is set to Eco mode.	–



## Common Problems & Solutions

Problem	Check These Items
Does not turn on	<ul style="list-style-type: none"> <li>• Check that the power cable is plugged in and that the power button on the projector cabinet or the remote control is on. See pages E-16 and 17.</li> <li>• Ensure that the lamp cover or lamp housing is installed correctly. See page E-30.</li> <li>• Check to see if the projector has overheated or the lamp has reached the end of its usable life. If there is insufficient ventilation around the projector or if the room where you're presenting is particularly warm, move the projector to a cooler location.</li> </ul>
No picture	<ul style="list-style-type: none"> <li>• Use the RGB, Video or S-Video button on the remote control or the cabinet to select your source (RGB, Video or S-Video). See page E-18.</li> <li>• Ensure your cables are connected properly.</li> <li>• Use menus to adjust the brightness and contrast. See page E-26.</li> <li>• Remove the lens cap.</li> <li>• Reset the settings or adjustments to factory preset levels using "Factory Default" in the menu. See page E-29.</li> <li>• Enter your registered keyword if the Security function is enabled. See page E-28.</li> </ul>
Image isn't square to the screen	<ul style="list-style-type: none"> <li>• Reposition the projector to improve its angle to the screen. See page E-18.</li> <li>• Use the Keystone correction function to correct the trapezoid distortion. See page E-19.</li> </ul>
Picture is blurred	<ul style="list-style-type: none"> <li>• Adjust the focus. See page E-19.</li> <li>• Reposition the projector to improve its angle to the screen. See page E-18.</li> <li>• Ensure that the distance between the projector and screen is within the adjustment range of the lens. See pages E-11 and 12.</li> <li>• Condensation may form on the lens if the projector is cold, brought into a warm place and is then turned on. Should this happen, let the projector stand until there is no condensation on the lens.</li> </ul>
Image is scrolling vertically, horizontally or both	<ul style="list-style-type: none"> <li>• Use the RGB, VIDEO or S-VIDEO button on the remote control or the cabinet to select the source you want to input.</li> </ul>
Remote control does not work	<ul style="list-style-type: none"> <li>• Install new batteries. See page E-10.</li> <li>• Make sure there are no obstacles between you and the projector.</li> <li>• Stand within 22 feet (7 m) of the projector. See page E-10.</li> <li>• Make sure that you are in the Projector mode and the PJ button lights in red. If not, press the PJ button. See page E-21.</li> </ul>
Indicator is lit or blinking	<ul style="list-style-type: none"> <li>• See the Power/Status/Lamp Indicator on page E-32.</li> </ul>
Cross color in RGB mode	<ul style="list-style-type: none"> <li>• If Auto Adjust is off, turn it on or adjust the image manually with Horizontal / Vertical / Clock / Phase in the Advanced menu. See page E-29.</li> </ul>

# SPECIFICATIONS

This section provides technical information about the VT660K/VT560/VT465 Projector's performance.

## Model Number VT660K/VT560/VT465

### Optical

LCD Panel	VT660K: 0.7" p-Si TFT active-matrix with Micro Lens Array VT560/VT465: 0.7" p-Si TFT active-matrix
Resolution	VT660K/VT560: 1024×768 pixels* native, up to UXGA with Advanced AccuBlend VT465: 800×600 pixels* native, up to UXGA with Advanced AccuBlend
Lens	Manual zoom and focus: F1.7 - 2.0 f=21.6 - 25.9mm
Lamp	VT660K/VT465: 205W (164W Eco mode) VT560: 200W (160W Eco mode)
Image Size	21 - 300 inches (0.5 - 7.6 m) diagonal
Projection Distance	2.38 - 35.8 ft / 0.7 (Tele) - 10.9 m (Tele)
Projection Angle	Tele : 9.5° - 10.0° Wide : 11.3° - 11.8°
Keystone Correction	+/- 30 degrees electronic (auto)

### Electrical

Inputs	1 RGB/Component (D-Sub 15 Pin), 1 S-Video (DIN 4 Pin), 1 Video (RCA), 1 Stereo Mini Audio, 2 (L/R) RCA Audio, 1 PC Control (DIN 8 Pin)
Outputs	1 RGB (D-Sub 15 Pin), 1 Stereo Mini Audio
USB Port	1 B Type
Video Compatibility	NTSC, NTSC4.43, PAL, PAL-60, PAL-N, PAL-M, SECAM, HDTV: 1080i, 1080i/50Hz, 720p, 576p, 480p, 480i/60Hz
Scan Rate	Horizontal: 15 kHz to 100 kHz (RGB: 24 kHz or over) / Vertical: 50 Hz to 120 Hz
Video Bandwidth	RGB: 80 MHz (-3dB)
Color Reproduction	16.7 million colors simultaneously, Full color
Horizontal Resolution	NTSC / NTSC4.43/PAL/PAL-M/PAL-N/PAL60: 550 TV lines SECAM: 350 TV lines YCbCr: 800 TV lines RGB: VT660K/VT560 / 1024 dots (H)×768 dots (V), VT465 / 800 dots (H)×600 dots (V)
External Control	RS232, IR
Sync Compatibility	Separate Sync / Composite Sync / Sync on G
Built-in Speaker	1W (monaural)
Power Requirement	100 - 120V AC / 200 - 240V AC, 50 / 60 Hz
Input Current	VT660K/VT465: 3.1A (100 - 120V AC) / 1.5A (200 - 240V AC) VT560: 2.9A (100 - 120V AC) / 1.4A (200 - 240V AC)
Power Consumption	VT660K/VT465: 7.5W in Standby mode / 270 W in Lamp Normal mode / 220 W in Lamp Eco mode VT560: 7.5W in Standby mode / 260 W in Lamp Normal mode / 220 W in Lamp Eco mode

### Mechanical

Installation Orientation	Desktop/Front, Desktop/Rear, Ceiling/Front, Ceiling/Rear
Dimensions	12.2" (W)×3.5" (H)×9.1" (D) 310mm (W)×89mm (H)×230mm (D) (not including protrusions)
Net Weight	6.5 lbs / 2.9 kg
Environmental Considerations	Operational Temperatures : 32° to 95°F (0° to 35°C), 20% to 80% humidity (non-condensing) Storage Temperatures : 14° to 122°F (-10° to 50°C), 20% to 80% humidity (non-condensing)
Regulations	UL Approved (UL 60950, CSA 60950) Meets DOC Canada Class B requirements Meets FCC Class B requirements Meets AS/NZS3548 Class B Meets EMC Directive (EN55022:1998, EN55024-1998, EN61000-3-2, EN61000-3-3) Meets Low Voltage Directive (EN60950, TUV GS Approved)



For additional information visit:

US : <http://www.necvisualsystems.com>

Europe : <http://www.nec-europe.com/>

Global : <http://www.nec-pj.com/>

\*Effective pixels are more than 99.99%.

The specifications are subject to change without notice.

# APPENDIX

## Cabinet Dimensions

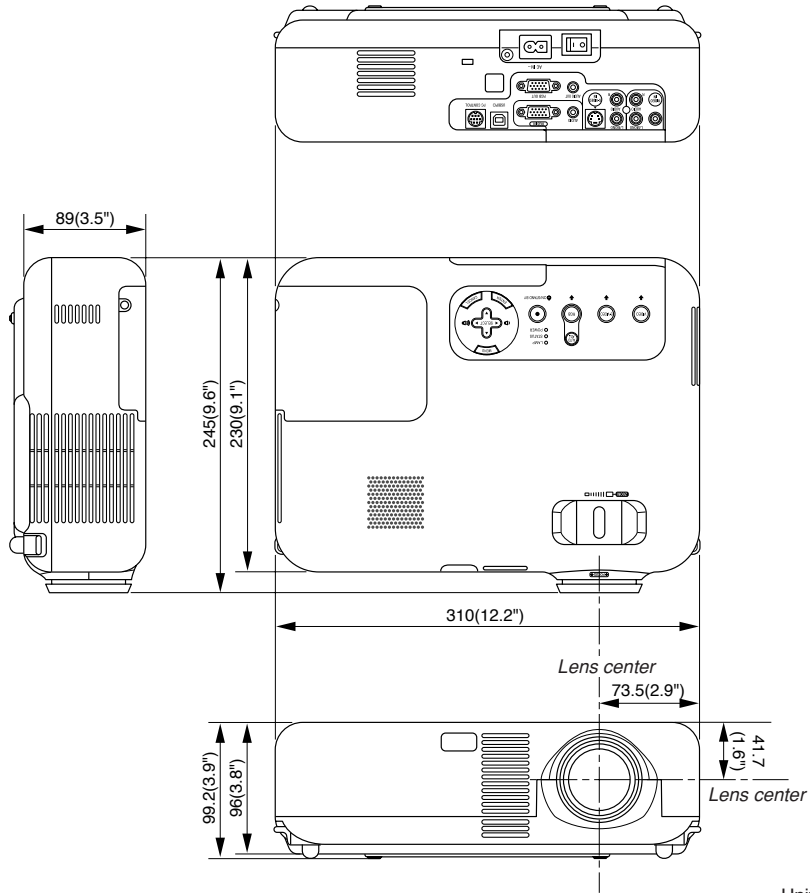

## Pin Assignments of D-Sub RGB Input Connector

### Mini D-Sub 15 Pin Connector

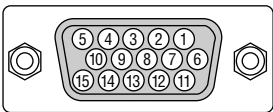

Signal Level  
Video signal : 0.7Vp-p (Analog)  
Sync signal : TTL level

Pin No.	RGB Signal (Analog)	YCbCr Signal
1	Red	Cr
2	Green or Sync on Green	Y
3	Blue	Cb
4	Ground	
5	Ground	
6	Red Ground	Cr Ground
7	Green Ground	Y Ground
8	Blue Ground	Cb Ground
9	No Connection	
10	Sync Signal Ground	
11	SCART Sync	
12	Bi-directional DATA (SDA)	
13	Horizontal Sync or Composite Sync	
14	Vertical Sync	
15	Data Clock	

## Compatible Input Signal List

Signal	Resolution ( Dots )	Frequency H. ( kHz )	Refresh Rate ( Hz )
NTSC	—	15.734	60
PAL	—	15.625	50
PAL60	—	15.734	60
SECAM	—	15.625	50
VESA	640 × 480	31.47	59.94
IBM	640 × 480	31.47	60
MAC	640 × 480	31.47	60
MAC	640 × 480	34.97	66.67
MAC	640 × 480	35	66.67
VESA	640 × 480	37.86	72.81
VESA	640 × 480	37.5	75
IBM	640 × 480	39.375	75
VESA	640 × 480	43.269	85.01
IBM	720 × 350	31.469	70.09
VESA	720 × 400	37.927	85.04
IBM	720 × 350	39.44	87.85
IBM	720 × 400	39.44	87.85
VESA	800 × 600	35.16	56.25
VESA	800 × 600	37.879	60.32
VESA	800 × 600	48.077	72.19
VESA	800 × 600	46.88	75
VESA	800 × 600	53.674	85.06
MAC	832 × 624	49.725	74.55
@ VESA	1024 × 768	35.5	43 Interlaced
@ VESA	1024 × 768	48.363	60
@ VESA	1024 × 768	56.476	70.07
@ MAC	1024 × 768	60.241	74.93
@ VESA	1024 × 768	60.023	75.03
@ VESA	1024 × 768	68.677	85
@ # VESA	1152 × 864	67.5	75
@ # MAC	1152 × 870	68.681	75.06
@ # SUN	1152 × 900	61.796	65.95
@ # SGI	1152 × 900	71.736	76.05
@ # VESA	1280 × 960	60	60
@ # VESA	1280 × 1024	63.981	60.02
@ # MAC	1280 × 1024	69.89	65.18
@ # HP	1280 × 1024	78.125	72.01
@ # SUN	1280 × 1024	81.13	76.11
@ # VESA	1280 × 1024	79.976	75.03
@ # VESA	1280 × 1024	91.146	85.02
@ # SXGA+	1400 × 1050	—	—
@ # HDTV (1080p)	1920 × 1080	67.5	60 Progressive
@ # SDTV(576i)(625i)	—	15.6	50
@ # SDTV(576p)(625p)	—	31.5	50
@ # HDTV (1080i)(1125i)	1920 × 1080	33.75	60 Interlace
@ # HDTV (1080i)(1125i)	1920 × 1080	28.125	50 Interlace
@ # HDTV (720p)(750p)	1280 × 720	45	60 Progressive
@ # SDTV (480p)(525p)	—	31.47	59.94 Progressive
@ # VESA	1600 × 1200	75.0	60
@ # VESA	1600 × 1200	81.25	65
@ # VESA	1600 × 1200	87.5	70
@ # VESA	1600 × 1200	93.75	75
DVD YCbCr	—	15.734	59.94 Interlaced
DVD YCbCr	—	15.625	50 Interlaced

# : Images in above flagged with # are compressed with Advanced AccuBlend on VT660K/VT560.  
 @ : Images in above flagged with @ are compressed with Advanced AccuBlend on VT465.

**NOTE:** Some composite sync signals may not be displayed correctly.

Signals other than those specified in the table above may not be displayed correctly. If this should happen, change the refresh rate or resolution on your PC. Refer to Display Properties help section of your PC for procedures.

UXGA (1600×1200) is supported for separate sync signal only.

## PC Control Codes

Function	Code Data
POWER ON	02H 00H 00H 00H 00H 02H
POWER OFF	02H 01H 00H 00H 00H 03H
INPUT SELECT RGB	02H 03H 00H 00H 02H 01H 01H 09H
INPUT SELECT VIDEO	02H 03H 00H 00H 02H 01H 06H 0EH
INPUT SELECT S-VIDEO	02H 03H 00H 00H 02H 01H 0BH 13H
PICTURE MUTE ON	02H 10H 00H 00H 00H 12H
PICTURE MUTE OFF	02H 11H 00H 00H 00H 13H
SOUND MUTE ON	02H 12H 00H 00H 00H 14H
SOUND MUTE OFF	02H 13H 00H 00H 00H 15H

**NOTE:** Contact your local dealer for a full list of the PC Control Codes if needed.

## Cable Connection

### Communication Protocol

Baud rate:	19200 bps
Data length:	8 bits
Parity:	No parity
Stop bit:	One bit
X on/off:	None
Communications procedure:	Full duplex

### PC Control Connector (DIN-8P)

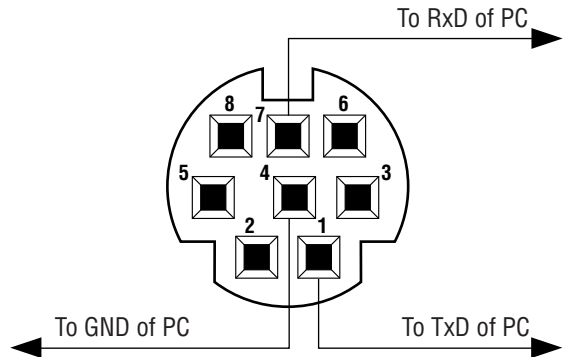

**NOTE:** Pins 2, 3, 5, 6 and 8 are used inside the projector.

## TravelCare Guide

### TravelCare - a service for international travelers

This product is eligible for "TravelCare", NEC's unique international warranty.

Please note that TravelCare coverage differs in part from coverage under the warranty included with the product.

### Services offered with TravelCare

This warranty allows customers to receive service on their product at the NEC and NEC-designated service stations in the countries listed herein when temporarily traveling internationally for business or pleasure.

For details on services offered by the different service stations, please refer to the "List of TravelCare Outlets" below.

#### 1 Repair services

The product will be repaired and delivered within 10 business days, not including shipping time.

During the term of warranty, the cost of maintenance parts, labor costs for repairs and shipping costs within the service station's coverage area are covered by the warranty.

#### 2 Replacement product rental service

If the customer desires, he or she can rent a replacement product while the original product is being repaired.

Fee: US\$200 for 12 days

This fee must be paid at the local service station in cash or credit card.

The \$200 rental fee is non-refundable even if the customer rents it less than 12 days before returning.

The replacement product will be delivered within 3 business days.

If the customer did not return the replacement product within 12 days, the customer will be charged the price of the unit.

If the customer returned the replacement product in a faulty or damaged condition, the repair cost will be charged to the customer.

Note that this service is not offered in all countries and regions. Please refer to the "List of TravelCare Outlets".

In addition, this replacement product rental service is not offered after the product's warranty has expired.

### Term of warranty

1

- a. Upon presentation of the warranty or receipt received upon purchase:

*Valid for the term indicated on the warranty or the normal term of warranty for the country of purchase.*

- b. When only the product is brought in:

*Valid for a period of within 14 months of the date of manufacture indicated by the serial number attached to the product.*

2 When a product whose term of warranty is expired is brought in:

Repairs will be offered for a fee. In this case the customer is not eligible for the replacement product rental service.

3 In the following cases, repairs may be charged, even if the product's warranty is still in effect:

- 1) If the term of warranty, model name, serial number and name of the store of purchase are not indicated on the warranty or have been altered.
- 2) Problems or damage caused by dropping or shocks during shipment or movement by the customer or by improper handling by the customers.
- 3) Problems or damage caused by improper usage or unwarrantable alterations or repairs by the customer.
- 4) Problems or damage caused by fire, salt damage, gas damage, earthquakes, lightning damage, storm or flood damage or other natural disasters or such external factors as dust, cigarette smoke, abnormal voltage, etc.
- 5) Problems or damage caused by use in hot or humid places, in vehicles, boats or ships, etc.

6) Problems or damage caused by expendable supplies or devices connected to the product other than those designated by NEC.

7) Problems caused by natural consumption, wear or deterioration of parts under normal usage conditions.

8) Problems or damage to lamps and other expendable supplies, included parts or optional parts.

9) Other conditions stipulated in the warranty included with the product also apply.

**NOTE:** The product can be used overseas with voltages of 100 to 120V and 200 to 240V by using a power cable suited for the standards and power source voltage of the country in which the product is being used.

### List of TravelCare Outlets

This list applies as of June 1, 2002.

For the most up-to-date information, please refer to the websites of the service stations in the various countries on the List of TravelCare Outlets or to the NEC website at <http://www.nec-pj.com>.

#### In Europe

NEC Europe, Ltd. / European Technical Centre

Address: Unit G, Stafford Park 12, Telford TF3 3BJ, U.K.

Telephone: +44 1952 237000

Fax Line: +44 1952 237006

Email Address: [AFR@uk.necur.com](mailto:AFR@uk.necur.com)

WEB Address: <http://www.necur.com>

(Regions Covered)

EU: Austria\*, Belgium\*, Denmark\*, Finland\*, France\*, Germany\*, Greece\*, Ireland\*, Italy\*, Luxembourg\*, The Netherlands\*, Portugal\*, Spain\*, Sweden\* and the United Kingdom\*

EEA: Norway\*, Iceland and Liechtenstein

#### In North America

NEC Solutions (America), Inc.

Address: 1250 Arlington Heights Road, Itasca, Illinois 60143, U.S.A.

Telephone: +1 800 836 0655

Fax Line: +1 800 356 2415

Email Address: [vsd-tech-support@necsam.com](mailto:vsd-tech-support@necsam.com)

WEB Address: <http://www.necvisualsystems.com>

(Regions Covered)

U.S.A. \*, Canada\*

#### In Oceania

NEC Australia Pty., Ltd.

Address: New South Wales;

184 Milperra Road, Reversby 2212

Victoria;

480 Princess Hwy Noble Park 3174

South Australia;

84A Richmond Road, Keswick 5035

Queensland;

116 Ipswich Road, Woollongabba 4102

Western Australia;

45 Sarich Court Osborne Park 6017

Telephone: 131 632 (from domestic)

+61 8 8375 5706 (from overseas)

Fax Line: +61 8 8375 5757

Email Address: [lee.gramola@nec.com.au](mailto:lee.gramola@nec.com.au)

WEB Address: <http://www.nec.com.au>

(Regions Covered)

Australia\*, New Zealand

**In Asia and Middle East**

## NEC Viewtechnology, Ltd.

Address: 686-1, Nishioi, Oi-Machi, Ashigarakami-Gun,  
Kanagawa 258-0017, Japan  
Telephone: +81 465 85 2369  
Fax Line: +81 465 85 2393  
Email Address: support\_pjweb@nevt.nec.co.jp  
WEB Address: http://www.nec-pj.com

(Regions Covered)  
Japan\*

## NEC Hong Kong Ltd.

Address: 11th Floor, Tower B, New Mandarin Plaza, 14  
Science Museum Road,  
Tsim Sha Tsui East, Kowloon, Hong Kong  
Telephone: +852 2369 0335  
Fax Line: +852 2795 6618  
Email Address: esmond\_au@nechk.nec.com.hk  
WEB Address: http://www.nec.com.hk

(Regions Covered)  
Hong Kong

## NEC Taiwan Ltd.

Address: 7F, No.167, SEC.2, Nan King East Road, Taipei,  
Taiwan, R.O.C.  
Telephone: +886 2 8500 1734  
Fax Line: +886 2 8500 1420  
Email Address: nickliao@nec.com.tw  
WEB Address: http://www.nec.com.tw

(Regions Covered)  
Taiwan

## NEC Singapore Pte. Ltd

Address: 401 Commonwealth Drive, #07-02, Haw Par  
Technocentre, Singapore 149598  
Telephone: +65 6 273 8333  
Fax Line: +65 6 274 2226  
Email Address: daniel@rsc.necsin.nec.com.sg  
WEB Address: http://www.nec.com.sg

(Regions Covered)  
Singapore

## Hyosung Data System, Ltd.

Address: 7th Floor, Cheongdam Building, 52,  
Cheongdam-Dong,  
Kangnam-Ku, Seoul, Korea 135-100  
Telephone: +82 2 510 0234  
Fax Line: +82 2 540 3590  
Email Address: hds-ykc@hyosung.com

(Regions Covered)  
South Korea

## Lenso Communication Co., Ltd.

Address: 292 Lenso House 4, 1st Floor, Srinakarin Road,  
Huamark, Bangkok, Bangkok 10240, Thailand  
Telephone: +66 2 375 2425  
Fax Line: +66 2 375 2434  
Email Address: pattara@lenso.com  
WEB Address: http://www.lenso.com

(Regions Covered)  
Thailand

## ABBA Electronics L.L.C.

Address: Tariq Bin Ziyad Road, P.O.Box 327, Dubai,  
United Arab Emirates  
Telephone: +971 4 371800  
Fax Line: +971 4 364283  
Email Address: ABBA@emirates.net.ae

(Regions Covered)  
United Arab Emirates

## Samir Photographic Supplies

Address: P.O.Box 599, Jeddah 21421, Saudi Arabia  
Telephone: +966 2 6828219  
Fax Line: +966 2 6830820  
Email Address: vartkes@samir-photo.com

(Regions Covered)  
Saudi Arabia

---

**NOTE:** In countries designated with an asterisk(\*), replacement product rental service are offered.

---

Date: / / ,

P-1/ ,

**TO: NEC or NEC's Authorized Service Station:**

**FM:**

\_\_\_\_\_  
(Company & Name with signature)

Dear Sir (s),

I would like to apply your TravelCare Service Program based on attached registration and qualification sheet and agree with your following conditions, and also the Service fee will be charged to my credit card account, if I don't return the Loan units within the specified period. I also confirm following information is correct. Regards.

***Application Sheet for TravelCare Service Program***

Country, product purchased :	
User's Company Name :	
User's Company Address : Phone No., Fax No. :	
User's Name :	
User's Address :	
Phone No., Fax No. :	
Local Contact office :	
Local Contact office Address :	
Phone No., Fax No. :	
User's Model Name :	
Date of Purchase :	
Serial No. on cabinet :	
Problem of units per User :	
Required Service :	(1) Repair and Return      (2) Loan unit
Requested period of Loan unit :	
Payment method :	(1) Credit Card      (2) Travelers Cheque      (3) Cash
In Case of Credit Card : Card No. w/Valid Date :	



## Condition of your TravelCare Service Program

Enduser is requested to understand following condition of TravelCare Service Program and fill necessary information into the application sheet.

### 1. Service Options:

There are 3 types of "Service" available. Enduser has to understand following condition and is required to fill in the Application Sheet.

#### 1) Repair and Return:

The 'Faulty unit' is sent or collected from the customer. It is repaired and returned within 10 days to the customer, excluding transport time.

There may have a case, repair and return can't be done by NEC Authorized Service Station, because of shortage of spare parts due to same model is not sold in the territory.

#### 2) Repair and Return with Loan: (This service is limited to some Service Stations)

This service is offered to the Enduser, who cannot wait until their unit is repaired.

The customer can borrow a unit for \$200 up to 12 days. Customer then sends in inoperable unit to nearest NEC Authorized Service Station for service. In order to prevent collection problem, Enduser is required to fill in Application Sheet.

Enduser needs to confirm the availability of the Service to NEC Authorized Service Stations.

#### 3) Loan Only:

For this service, NEC Authorized Service Station supplies the customer with a loan unit for US\$200 up to 12 days. Customer keeps the inoperable unit and when customer returns home, customer arranges to have the projector serviced in the home country.

## 2. Warranty Exclusions:

This program does not apply if the Projector's serial number has been defaced, modified or removed.

If, in the judgement of NEC Authorized Service Station or its agent the defects or failures result from any cause other than fair wear and tear or NEC neglect, or fault including the following without limitation:

- 1) Accidents, transportation, neglect, misuse, abuse, water, dust, smoke or default of or by the Customer its employees or agents or any third party;
- 2) Failure or fluctuation of electrical power, electrical circuitry, air conditioning, humidity control or other environmental conditions such as use it in smoking area;
- 3) Any fault in the attachments or associated products or components (whether or not supplied by NEC or its agents which do not form part of the Product covered by this warranty);
- 4) Any act of God, fire, flood, war, act of violence or any similar occurrence;
- 5) Any attempt by any person other than any person authorized by NEC to adjust, modify, repair, install or service the product.
- 6) Any Cross-border charges such as, duty, insurance, tax etc.

## 3. Charges for Warranty Exclusions and Out of Warranty Case:

In case faulty unit is under warranty exclusions case or under Out of Warranty period, NEC Authorized Service Station will Inform estimation of actual service cost to the Enduser with reason.

## 4. Dead on Arrival (DOA):

Enduser must take this issue up with their original supplier in the country of purchase.

NEC Authorized Service Station will repair the DOA unit as a Warranty repair, but will not exchange DOA unit with new units.

## 5. Loan Service Charges and Conditions:

Upon acceptance of this NEC Projector, Customer agrees to assume liability for this loan unit.

The current cost of use of this loan unit is \$200.00 USD for 12 calendar days.

If Customer does not return the unit within the 12 calendar days, Customer will be charged the next highest cost up to and including the full list price to Credit Cards, which price will be informed by NEC Authorized Service Stations. Please see the attached listing of contacts for each country to arrange for pickup of the loan unit.

If you return to their country of origin with the loan unit, you will be charged additional freight to return the unit to the loaning country.

Thank you for your understanding of this program.

**NEC**