

# **WT600**

## **Projector**

### **User's Manual**

**English**

**Deutsch**

**Français**

**Italiano**

**Español**

**Svenska**

**WARNING TO CALIFORNIA RESIDENTS:**

Handling the cables supplied with this product, will expose you to lead, a chemical known to the State of California to cause birth defects or other reproductive harm. Wash hands after handling.

# Important Information

## Safety Cautions

### Precautions

Please read this manual carefully before using your NEC WT600 Projector and keep the manual handy for future reference. Your serial number is located on the right side of your projector. Record it here:

#### CAUTION



To turn off main power, be sure to remove the plug from power outlet. The power outlet socket should be installed as near to the equipment as possible, and should be easily accessible.

#### CAUTION



TO PREVENT SHOCK, DO NOT OPEN THE CABINET. NO USER-SERVICEABLE PARTS INSIDE. REFER SERVICING TO QUALIFIED NEC SERVICE PERSONNEL.



This symbol warns the user that uninsulated voltage within the unit may be sufficient to cause electrical shock. Therefore, it is dangerous to make any kind of contact with any part inside of the unit.



This symbol alerts the user that important information concerning the operation and maintenance of this unit has been provided. The information should be read carefully to avoid problems.

#### WARNING

TO PREVENT FIRE OR SHOCK, DO NOT EXPOSE THIS UNIT TO RAIN OR MOISTURE. DO NOT USE THIS UNIT'S GROUNDED PLUG WITH AN EXTENSION CORD OR IN AN OUTLET UNLESS ALL THREE PRONGS CAN BE FULLY INSERTED. DO NOT OPEN THE CABINET. THERE ARE HIGH-VOLTAGE COMPONENTS INSIDE. ALL SERVICING MUST BE DONE BY QUALIFIED NEC SERVICE PERSONNEL.

### DOC Compliance Notice

This Class B digital apparatus meets all requirements of the Canadian Interference-Causing Equipment Regulations.

### Acoustic Noise Information Ordinance-3. GSGV:

The sound pressure level is less than 70 dB (A) according to ISO 3744 or ISO 7779.

	<b>CAUTION 注意</b>	RADIATION LASER NO	RAYONNEMENT LASER NE PAS	激光辐射
	LASER RADIATION-DO NOT STARE INTO BEAM	MIRE AL RAYO PRODUCTO	REGARDER DANS LE FAISCEAU	勿直视
	WAVE LENGTH:650nm	LASER CLASSE2	APPAREIL A LASER DE CLASSE2	激光束
	MAX OUTPUT:1mW	LASER-STRAHLUNG	レーザー 1mW max. 650nm	激光产品
CLASS II LASER PRODUCT	NICHT IN DEN STRAHL	レーザーのぞき込まないこと	不要	中国製造
CLASS 2 LASER PRODUCT	BLICKEN! LASER KLASSE2	クラス2レーザー製品	中国製造	中国製造
	EN60825-1:1994+A11:1996 JIS C 6802:1998 IEC 60825-1:1993+A1:1997	MADE IN CHINA		

This label is on the side of the remote control.

#### CAUTION



Do not look into the laser pointer while it is on and do not point the laser beam at a person. Serious injury could result.

## RF Interference

### WARNING

The Federal Communications Commission does not allow any modifications or changes to the unit EXCEPT those specified by NEC Solutions (America), Inc. in this manual. Failure to comply with this government regulation could void your right to operate this equipment. This equipment has been tested and found to comply with the limits for a Class B digital device, pursuant to Part 15 of the FCC Rules. These limits are designed to provide reasonable protection against harmful interference in a residential installation. This equipment generates, uses, and can radiate radio frequency energy and, if not installed and used in accordance with the instructions, may cause harmful interference to radio communications. However, there is no guarantee that interference will not occur in a particular installation. If this equipment does cause harmful interference to radio or television reception, which can be determined by turning the equipment off and on, the user is encouraged to try to correct the interference by one or more of the following measures:

- Reorient or relocate the receiving antenna.
- Increase the separation between the equipment and receiver.
- Connect the equipment into an outlet on a circuit different from that to which the receiver is connected.
- Consult the dealer or an experienced radio / TV technician for help.

In UK, a BS approved power cable with moulded plug has a Black (five Amps) fuse installed for use with this equipment. If a power cable is not supplied with this equipment please contact your supplier.

### Important Safeguards

These safety instructions are to ensure the long life of your projector and to prevent fire and shock. Please read them carefully and heed all warnings.

### Installation

1. For best results, use your projector in a darkened room.
2. Place the projector on a flat, level surface in a dry area away from dust and moisture.
3. Do not place your projector in direct sunlight, near heaters or heat radiating appliances.
4. Exposure to direct sunlight, smoke or steam can harm the mirror and internal components.
5. Handle your projector carefully. Dropping or jarring can damage internal components.
6. Do not place heavy objects on top of the projector.
7. If you wish to have the projector installed on the ceiling:
  - a. Do not attempt to install the projector yourself.
  - b. The projector must be installed by qualified technicians in order to ensure proper operation and reduce the risk of bodily injury.
  - c. In addition, the ceiling must be strong enough to support the projector and the installation must be in accordance with any local building codes.
  - d. Please consult your dealer for more information.

**Fire and Shock Precautions**

1. Ensure that there is sufficient ventilation and that vents are unobstructed to prevent the build-up of heat inside your projector. Allow at least 4 inches (10 cm) of space between your projector side and a wall.
2. Prevent foreign objects such as paper clips and bits of paper from falling into your projector.  
Do not attempt to retrieve any objects that might fall into your projector. Do not insert any metal objects such as a wire or screwdriver into your projector. If something should fall into your projector, disconnect it immediately and have the object removed by a qualified NEC service personnel.
3. Do not place any liquids on top of your projector.
4. Do not look into the mirror or the light source while the projector is on. Serious damage to your eyes could result.
5. Do not block the light path between the light source and the final mirror with any objects. Doing so could cause the object to catch on fire.
6. The projector is designed to operate on a power supply of 100-120 or 200-240 V 50/60 Hz AC. Ensure that your power supply fits this requirement before attempting to use your projector.
7. Handle the power cable carefully and avoid excessive bending.  
A damaged cord can cause electric shock or fire.
8. If the projector is not to be used for an extended period of time, disconnect the plug from the power outlet.

**CAUTION**

1. Do not try to touch the ventilation outlet on the both sides as it can become heated while the projector is turned on.
2. Do not attempt to move or carry the projector using the mirror cover.  
Doing so can result in the projector overturning and causing injury. Using the two side handles is the proper way to move the projector.  
When carrying or transporting the projector, close and lock the mirror cover with the mirror cover lock switch.
3. The carrying handles are designed for the purpose of carrying the projector.  
Do not hang from the projector by the carrying handles in a ceiling mounted installation. Doing so may result in the carrying handles separating from the unit or the projector may separate from the mount resulting in personal injury.
4. Enable High-Speed Fan mode if you continue to use the projector for consecutive days. (From the Advanced menu, select [Projector Options] → [Setup] → [Page 4] → [High Speed Fan Mode].)
5. Do not unplug the power cable from the wall outlet under any one of the following circumstances.  
Doing so can cause damage to the projector:
  - \* While the Hour Glass icon appears.
  - \* While the message "Please wait a moment." appears. This message will be displayed after the projector is turned off.
  - \* While the cooling fans are running. (The cooling fans continue to work for 90 seconds after the projector is turned off).

6. Do not eject the PC card or LAN card while its data is being accessed. Doing so can damage your PC card or LAN card.

**Lamp Replacement**

- To replace the lamp, follow all instructions provided on page 7-1.
- Be sure to replace the lamp when the message "**The lamp has reached the end of its usable life. Please replace the lamp.**" appears. If you continue to use the lamp after the lamp has reached the end of its usable life, the lamp bulb may shatter, and pieces of glass may be scattered in the lamp case. Do not touch them as the pieces of glass may cause injury.  
If this happens, contact your NEC dealer for lamp replacement.
- Allow a minimum of 90 seconds to elapse after turning off the projector. Then turn off the main power switch, disconnect the power cable and allow 60 minutes to cool the projector before replacing the lamp.

**What's in the Box?**

Make sure your box contains everything listed. If any pieces are missing, contact your dealer. Please save the original box and packing materials if you ever need to ship your WT600 Projector.

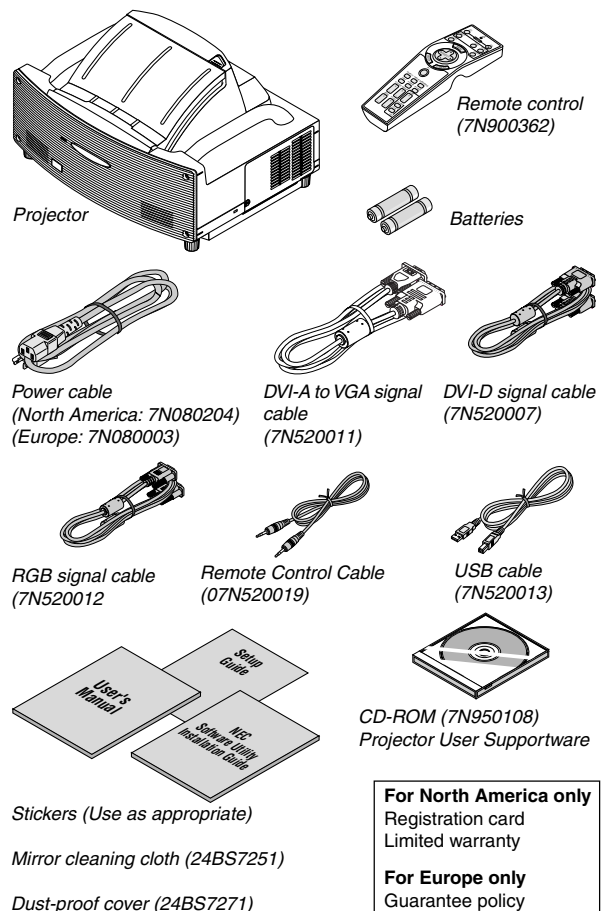

# Table of Contents

<b>Important Information .....</b>	<b>ii</b>		
Safety Cautions .....	ii		
What's in the Box? .....	iii		
<b>1. Introduction .....</b>	<b>1-1</b>		
1-1. Introduction to the Projector .....	1-1		
1-2. Part Names of the Projector .....	1-2		
Opening and Closing the Mirror Cover .....	1-3		
Top Features .....	1-4		
Terminal Panel Features .....	1-5		
1-3. Part Names of the Remote Control .....	1-6		
Battery Installation .....	1-8		
Remote Control Precautions .....	1-8		
Operating Range for Wireless Remote Control .....	1-8		
Using the Remote Control in Wired Operation .....	1-8		
<b>2. Installation and Connections .....</b>	<b>2-1</b>		
2-1. Setting Up the Screen and the Projector .....	2-2		
Selecting a Location .....	2-2		
Screen Dimensions .....	2-2		
Throw Distance .....	2-2		
2-2. Making Connections .....	2-3		
When Viewing a DVI Digital Signal .....	2-3		
Connecting Your PC or Macintosh Computer .....	2-3		
To connect SCART output (RGB) .....	2-4		
Using two RGB inputs simultaneously .....	2-4		
Connecting an External Monitor .....	2-5		
Connecting Your DVD Player .....	2-6		
Connecting Your VCR or Laser Disc Player .....	2-7		
Connecting the Supplied Power Cable .....	2-7		
<b>3. Projecting an Image (Basic Operation) .....</b>	<b>3-1</b>		
3-1. Turning on the Projector .....	3-1		
3-2. Selecting a Source .....	3-2		
3-3. Adjusting the Picture Size and Position .....	3-2		
3-4. Optimizing RGB Picture Automatically .....	3-4		
3-5. Turning Up or Down Volume .....	3-4		
3-6. Using the Laser Pointer .....	3-4		
3-7. Turning off the Projector .....	3-5		
<b>4. Convenient Features .....</b>	<b>4-1</b>		
4-1. Using the Remote Mouse Function .....	4-1		
4-2. Turning Off the Image and Sound .....	4-2		
4-3. Freezing a Picture .....	4-2		
4-4. Using the Pointer .....	4-2		
4-5. Enlarging and Moving a Picture .....	4-3		
4-6. Getting the On-line Help .....	4-3		
4-7. Using a USB Mouse .....	4-3		
4-8. Changing Background Logo .....	4-4		
4-9. Making Freehand Drawings on a Projected Image (ChalkBoard) .....	4-4		
4-10. USB Memory Device or USB Memory Card Reader Support .....	4-5		
<b>5. Using the Viewer .....</b>	<b>5-1</b>		
5-1. Making the Most out of the Viewer Function .....	5-1		
5-2. Operating the Viewer Function from the Projector (playback) .....	5-2		
Projecting slides (Viewer) .....	5-2		
Auto Play Mode .....	5-3		
Switching to Slides Directly from Other Input Modes .....	5-3		
Viewing Digital Images .....	5-3		
Storing Images Displayed on the Projector on the PC card (Capture) .....	5-3		
Deleting Captured Images .....	5-4		
Using the PC Card Files Function (PC Card Files) .....	5-4		
<b>6. Using On-Screen Menu .....</b>	<b>6-1</b>		
6-1. Basic Menu Operation .....	6-1		
Using the Menus .....	6-1		
Customizing the Menu .....	6-1		
6-2. Menu Tree .....	6-2		
6-3. Menu Elements .....	6-5		
6-4. Entering Alphanumeric Characters by Using the Menu .....	6-6		
6-5. Menu Descriptions & Functions .....	6-6		
Source Select .....	6-6		
RGB/Video/S-Video/DVI (DIGITAL/ANALOG)/Viewer/LAN/Entry List .....	6-7		
Picture .....	6-7		
Volume .....	6-7		
Image Options .....	6-8		
Selecting Aspect Ratio .....	6-8		
Masking Unwanted Area (Blanking) .....	6-8		
Adjusting Position and Clock .....	6-8		
Selecting Resolution .....	6-8		
Selecting Overscan Percentage .....	6-8		
Selecting Video Filter Level .....	6-9		
Selecting Noise Reduction Level .....	6-9		
Signal Type .....	6-9		
Picture Management .....	6-9		
User Adjust (when using User 1 to 4) .....	6-9		
Selecting Gamma Correction Mode .....	6-9		
Selecting Color Correction .....	6-9		
Selecting White Peaking .....	6-9		
Adjusting Color Temperature and White Balance .....	6-10		
Selecting Base Setting .....	6-10		
Presentation/sRGB/Graphic/Video/Movie .....	6-10		
Projector Options .....	6-10		
Using 3D Reform .....	6-10		
Digital Zoom .....	6-13		
Menu [Page 1] .....	6-14		
Selecting Menu Language/Selecting Menu Mode/Customizing the Menu/Selecting a Projector Pointer Icon/Selecting a Mouse Pointer Icon/Selecting Menu Display Time .....	6-14		
Menu [Page 2] .....	6-14		
Turning On / Off Source Display/Turning On / Off Message/Selecting Menu Color .....	6-15		
Setup [Page 1] .....	6-15		
Setting Lamp Mode to Normal or Eco/Selecting Projector Orientation/Selecting a Color or Logo for Background/Setting RGB for RGB OUT/Setting Closed Caption .....	6-15		
Setup [Page 2] .....	6-15		
Setting Viewer Options/Selecting Capture Options/Setting Mouse Button and Sensitivity .....	6-16		
Setup [Page 3] .....	6-16		
Selecting Signal Format .....	6-16		
Setup [Page 4] .....	6-16		
Enabling Auto Adjust/Enabling Auto Start/Enabling Power Management/Enabling Power Off Confirmation/Enabling Horizontal and Vertical Keystone Correction Save/Enabling High Speed Fan Mode/Enabling Idle Mode/Clearing Lamp Hour Meter .....	6-17		
Setup [Page 5] .....	6-17		
Selecting Communication Speed/Selecting Default Source/Disabling the Cabinet Buttons .....	6-18		
Selecting Aspect Ratio and Position for Screen .....	6-18		
Setting LAN Mode .....	6-18		
IP Address .....	6-18		
Network Type (required for wireless only) .....	6-19		
WEP (for Wireless only) .....	6-19		
Mail .....	6-20		
Status .....	6-21		
DHCP .....	6-21		
Setting a Password .....	6-22		
Security .....	6-23		
Tools .....	6-25		
Using Sleep Timer .....	6-25		
Using Capture .....	6-25		
Using PC Card Files .....	6-25		
Using ChalkBoard .....	6-25		
Help .....	6-25		
Contents .....	6-25		
Information .....	6-25		
Remaining Lamp Time Display .....	6-25		
Returning to Factory Default .....	6-25		
<b>7. Maintenance .....</b>	<b>7-1</b>		
7-1. Replacing the Lamp .....	7-1		
7-2. Cleaning .....	7-2		
Cleaning the Cabinet .....	7-2		
Handling and Care of Mirror surface .....	7-2		
<b>8. Troubleshooting .....</b>	<b>8-1</b>		
8-1. Power Indicator .....	8-1		
8-2. Status Indicator .....	8-1		
8-3. Lamp Indicator .....	8-1		
8-4. Common Problems & Solutions .....	8-2		
<b>9. Specification .....</b>	<b>9-1</b>		
<b>10. Appendix .....</b>	<b>10-1</b>		
10-1. Cabinet Dimensions .....	10-1		
10-2. Pin Assignments of D-Sub RGB Input Connector .....	10-2		
10-3. Compatible Input Signal List .....	10-3		
10-4. PC Control Codes and Cable Connection .....	10-4		
10-5. Using Software Keyboard .....	10-5		
10-6. Operation Using an HTTP Brouter .....	10-6		

# 1. Introduction

## 1-1. Introduction to the Projector

This section introduces you to the WT600 Projector and describes key features and controls.

### Congratulations on Your Purchase of The WT600 Projector

The WT600 is a sophisticated for aspherical mirror XGA projector. With the WT600 you will be able to project images up to 100" (measured diagonally) from your DVD player, VCR, satellite hookup, HDTV source, PC, Workstation or Macintosh computer (desktop or notebook) and images from your digital camera PC Card or compact flash memory. The WT600 provides for wireless or wired network connectivity when used with an optional network PC card. With input and output flexibility, long lamp life and a full function remote, the WT600 lets you immerse yourself in short throw large screen viewing.)

### Features you'll enjoy on the WT600:

- Super short focal length
- 40" to 100" diagonal image display from 26 inches or less to the screen
- Wireless or wired networking capable
- Email projector status information to selected individuals
- USB memory storage provides for computerless presentations
- UXGA compatible, XGA native resolution
- Sealed optics reduce maintenance when used in smoky or dusty environments
- Core technologies – Advanced AccuBlend™, Advanced AutoSense™, VORTEX Technology Plus™ for highest quality of image display and ease of use
- 3DReform enhanced image technology for increased projector versatility that provides for horizontal, vertical and diagonal keystone correction
- Display 16:9 or 4:3 information and fill the screen
- HDTV (1080p, 1080i, 720p) and SDTV (576p, 576i, 480p, 480i) compatibility
- Smart security settings for password protection, control panel lock, menu lock and PC card protection key to help prevent unauthorized access and adjustments to the projector
- ADA508 and Executive Order 13221 Federal Government compliance
- Digital photo viewer to display larger than life images from your digital cameras PC card or compact flash card
- Easy set up and operation
- Eco-mode™ lamp technology for increased lamp life and energy savings
- Wireless and wired remote control operation
- External control via RS232, USB or Network
- NEC exclusive Advanced AccuBlend intelligent pixel blending technology provides for extremely accurate image compression and HDTV (1920 × 1080) display resolution\*2

- Supports most IBM VGA, SVGA, XGA, Macintosh, component signal (YCbCr/YPbPr) or other RGB signals within a horizontal frequency range of 15 to 100 kHz and a vertical frequency range of 50 to 120 Hz. This includes NTSC, NTSC4.43, PAL, PAL-M, PAL-N, PAL60 and SECAM standard video signals

---

*NOTE: Composite video standards are as follows:*

*NTSC: U.S. TV standard for video in U.S. and Canada.*

*NTSC4.43: TV standard used in Middle East countries.*

*PAL: TV standard used in Western Europe.*

*PAL-M: TV standard used in Brazil.*

*PAL-N: TV standard used in Argentine, Paraguay and Uruguay.*

*PAL60: TV standard used for NTSC playback on PAL TVs.*

*SECAM: TV standard used in France and Eastern Europe.*

---

- \*1 Do not attempt to mount the projector on the ceiling yourself. To ensure proper operation and reduce the risk of bodily injury a qualified technician must install the projector. In addition, the ceiling must be strong enough to support the projector and the installation must be in accordance with any local building codes. Please consult your dealer for more information.

- \*2 HDTV 1080p (1920 × 1080), HDTV 1080p (1920 × 1080) and HDTV 720 p (1280 × 720) are displayed with NECs Advanced AccuBlend technology

Thank you for your purchase of the NEC WT600 projector.

For additional information, please visit our website at:

US: <http://www.necvisualsystems.com>

Europe: <http://www.nec-europe.com/>

Global: <http://www.nec-pj.com/>

## 1-2. Part Names of the Projector

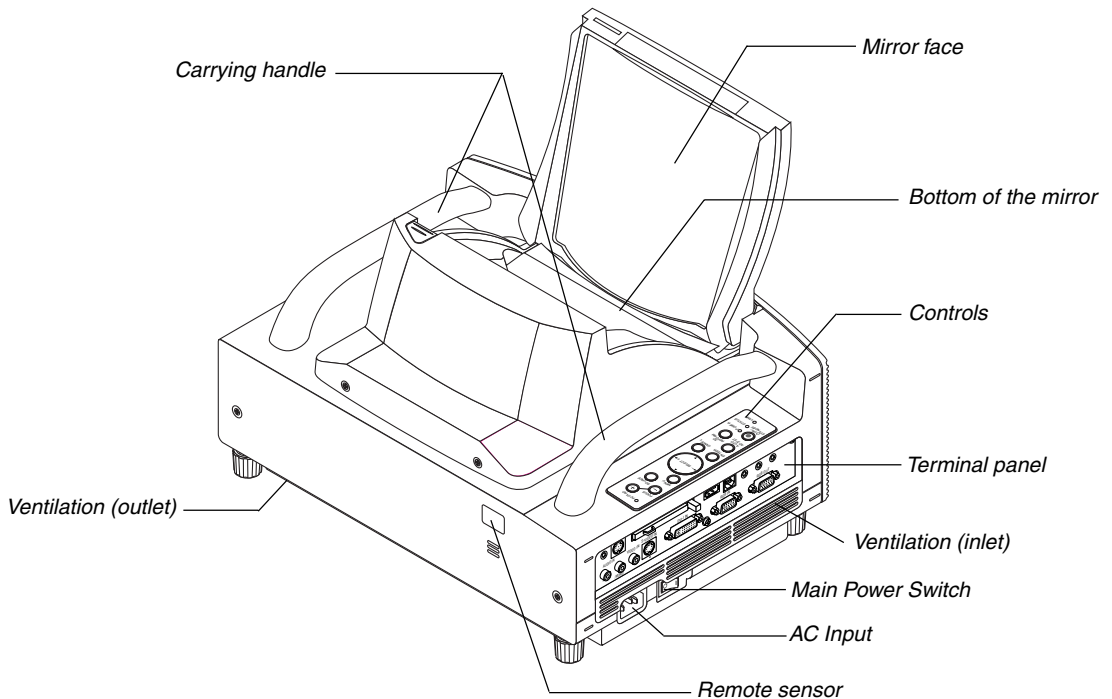
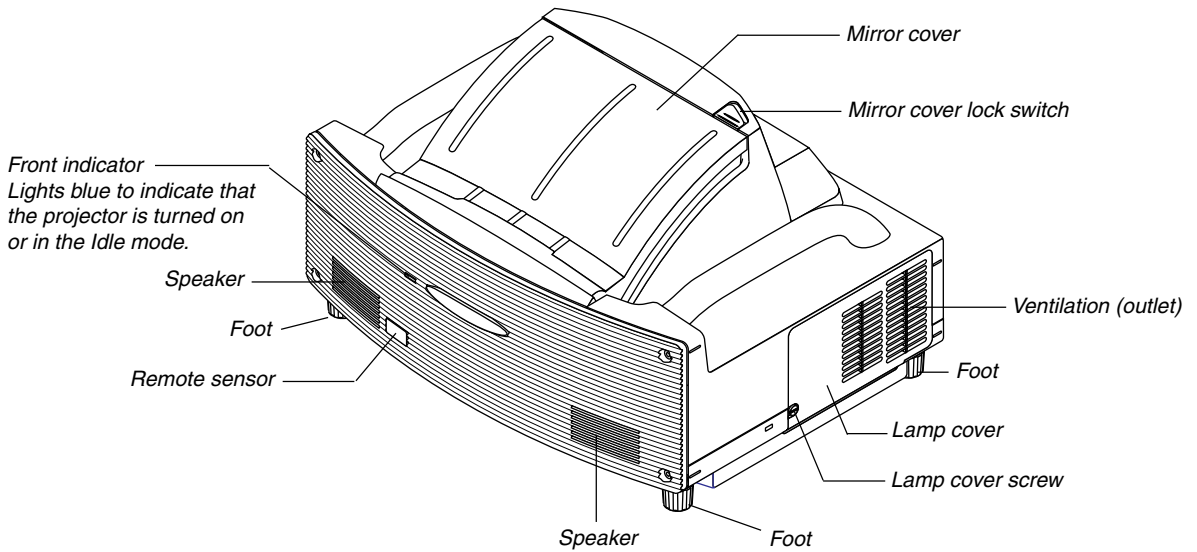

## Opening and Closing the Mirror Cover

To open the mirror cover:

1. Slide the mirror cover lock switch to the unlock position.

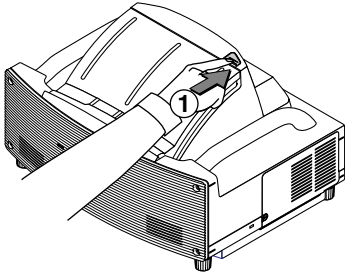

2. Slowly open the mirror cover holding both ends.

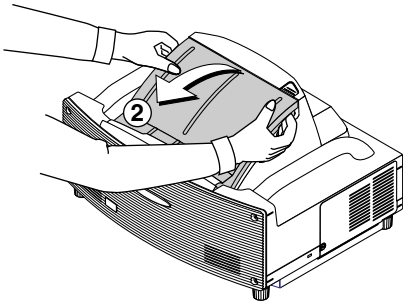

**NOTE:**

- Do not release your hold of the mirror cover until the mirror cover is fully open.
- Do not apply excessively strong pressure against the mirror cover or mirror surface while opening it.
- Keep finger prints off the mirror surface. Leaving finger prints in the mirror surface might cause an unwanted shadow and poor picture quality.

To close the mirror cover:

1. Slowly close the mirror cover while holding both ends.

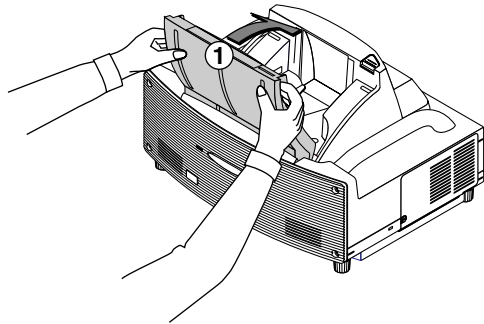

**NOTE:**

- Do not release your hold of the mirror cover until the mirror cover is fully closed.
- Do not apply excessively strong pressure against the mirror cover or mirror surface while closing it.
- Keep finger prints off the mirror surface. Leaving finger prints in the mirror surface might cause an unwanted shadow and poor picture quality.

2. Slide the mirror cover lock switch to the lock position.

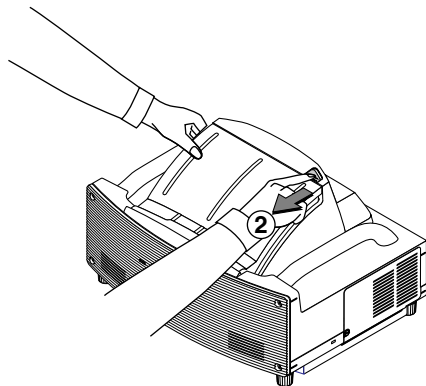

**NOTE:**

- The projector cannot be turned on when the mirror cover is closed.
- Keep any items out of the light path or the mirror. Failure to do so may cause objects to catch on fire in unexpected places.
- The projector has a sensor which detects an object in front of the largest mirror or in the light path. If the sensor detects any object, the projector will not turn on. If this happens while the projector is turned on, the image is muted. In either case the STATUS indicator lights in red.
- The projector has a temperature sensor which detects heat. If the sensor detects excessive heat in the bottom of the mirror or in the light path, the projector will not turn on. If this happens while the projector is turned on, the projector will turn off (the idle mode). In either case the STATUS indicator flashes in red.

**Top Features**

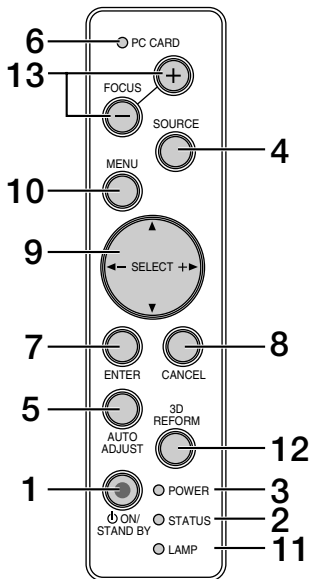

**1. POWER Button ( ON / STAND BY)**

Use this button to turn the power on and off when the main power is supplied and the projector is in the Idle or standby mode.

*NOTE: To turn on or off the projector, press and hold this button for a minimum of two seconds.*

**2. STATUS Indicator**

Informs you of the projector's status or what kind of error is occurring. See the Status Indicator section on page 8-1 for more details.

**3. POWER Indicator**

When this indicator is green, the projector is on; when this indicator is orange, it is in idle or standby mode. See the Power Indicator section on page 8-1 for more details.

**4. SOURCE Button**

Use this button to select a video source such as a PC, VCR, DVD player, Viewer (PC card), or LAN.

Press and release this button quickly to display the Source List.

Each time this button is pressed for a minimum of ONE second, the input source will change as follows:

RGB → DVI (DIGITAL) → DVI (ANALOG) → Video → S-Video → Viewer → RGB → ...

If no input signal is present, the input will be skipped.

**5. AUTO ADJUST Button**

Use this button to adjust Position-H/V and Pixel Clock/Phase for an optimal picture. Some signals may not be displayed correctly or take time to switch between sources.

**6. PC CARD Access Indicator**

Lights while accessing a PC card.

**7. ENTER Button**

Executes your menu selection and activates items selected from the menu.

**8. CANCEL Button**

Press this button to exit "Menus". Press this button to return the adjustments to the last condition while you are in the adjustment or setting menu.

**9. SELECT ▲▼◀▶ (+) (-) / Volume Buttons**

▲▼: Use these buttons to select the menu of the item you wish to adjust. When no menus appear, these buttons work as a volume control.

◀▶: Use these buttons to change the level of a selected menu item.

A press of the ▶ button executes the selection. When the menus or the Viewer tool bar is not displayed, these buttons can be used to select a slide, or to move the cursor in Folder List or Slide List.

When the pointer is displayed, these ▲▼◀▶ buttons move the pointer.

**10. MENU Button**

Displays the menu.

**11. LAMP Indicator**

If this light blinks red rapidly, it's warning you that the projection lamp has reached the end of its usable life.

After this light appears, replace the lamp as soon as possible. (See page 7-1). If this is lit green continually, it indicates that the lamp mode is set to Eco. See the Lamp Indicator section on page 8-1 for more details.

**12. 3D REFORM Button**

Press this button to enter 3D Reform mode to correct the distortion, and make the image square.

Each time this button is pressed, the item will change as follows:

Pincushion → Cornerstone → Keystone → ... (the three items are available only when no adjustment is made)

**13. FOCUS Button (+/-)**

Adjusts the focus.



## Terminal Panel Features

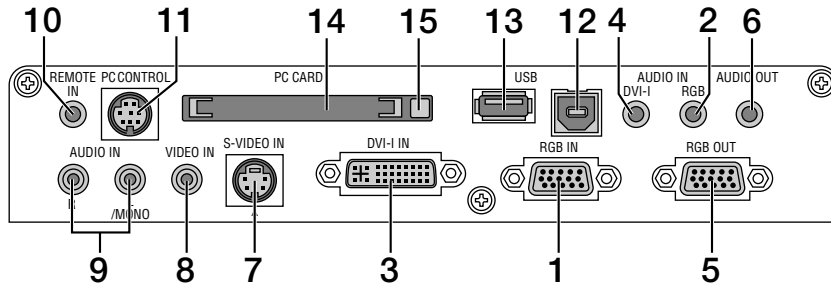

### 1. RGB IN / Component Input Connector (Mini D-Sub 15 Pin)

Connect your computer using the supplied RGB cable. This connector also supports a component signal and SCART output signal. See page 2-4 for more details.

### 2. RGB AUDIO IN Mini Jack (Stereo Mini)

This is where you connect audio output from your computer or DVD player. A commercially available audio cable is required.

### 3. DVI-I IN Connector (DVI-I 24 Pin)

Connect a computer with a DVI output using the supplied DVI-D cable.

This connector can be used to accept digital and analog signal output from a computer with a DVI connector.

### 4. DVI-I AUDIO Input Mini Jack (Stereo Mini)

This is where you connect the audio output from your computer when connected to the DVI input. A commercially available audio cable is required.

### 5. RGB OUT Connector (Mini D-Sub 15 Pin)

You can use this connector to loop your computer image to an external monitor from the RGB input source.

### 6. AUDIO OUT Mini Jack (Stereo Mini)

Connect an additional audio equipment here to listen to audio coming from your computer, Video or S- Video input.

Note that there is no audio output from this jack during Standby and Idle.

### 7. S-VIDEO IN Connector (Mini DIN 4 Pin)

Here is where you connect the S-Video input from an external source like a VCR.

*NOTE: S-Video provides more vivid color and higher resolution than the traditional composite video format.*

### 8. VIDEO IN Connector (RCA)

Connect a VCR, DVD player, laser disc player, or document camera here to project video.

### 9. VIDEO AUDIO IN Jacks (RCA)

L/MONO: This is your monaural or left channel audio input for stereo sound coming from the VIDEO source.

R: This is your right channel audio input for stereo sound from the VIDEO source.

### 10. REMOTE IN Jack (Mini Jack)

Connect your remote control cable here for wired operation.

### 11. PC CONTROL Port (Mini DIN 8 Pin)

Use this port to connect your PC to control your projector via a serial cable. This enables you to use your PC and serial communication protocol to control the projector. The NEC optional serial cable (CA03D) is required to use this port. You can also control the projector by using Dynamic Image Utility 2.0 included on the supplied CD-ROM.

To do so you must first have Dynamic Image Utility 2.0 installed on your PC. If you are writing your own program, typical PC control codes are on page 10-4. A cap is put on the port at the factory. Remove the cap when using the port.

### 12. USB Port (Type B)

Connect this port to the USB port (type A) of your PC using the supplied USB cable. You can operate your computer's mouse functions from the remote control.

### 13. USB Port (Type A)

Connect a commercially available mouse that supports USB. You can operate the menu or Viewer with the USB mouse via this port.

Note that this port should not be connected to a computer and that there may be some brands of USB mouse that the projector does not support.

### 14. PC CARD Slot

Insert a PC card, commercially available LAN card or NEC optional wireless LAN card here.

### 15. PC CARD Eject Button

Press to eject a PC card partially.

### 1-3. Part Names of the Remote Control

*NOTE: If you are using a Macintosh computer, you can click either the right-click or left-click button to activate the mouse.*

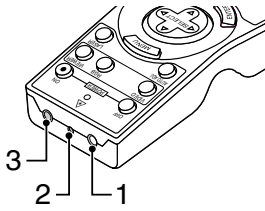

#### 1. Infrared Transmitter

Direct the remote control toward the remote sensor on the projector cabinet.

#### 2. LASER Pointer

Beams a laser light when the LASER button is pressed.

#### 3. Remote Jack

Connect your remote control cable here for wired operation.

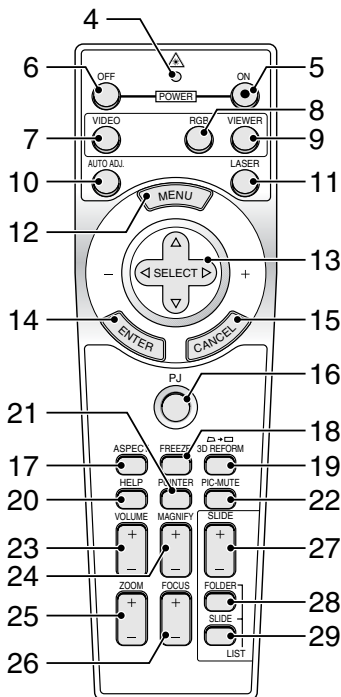

#### 4. LED

Flashes when any button is pressed.

#### 5. POWER ON Button

When the main power is on, you can use this button to turn your projector on.

*NOTE: To turn on the projector, press and hold the POWER ON button for a minimum of two seconds.*

#### 6. POWER OFF Button

You can use this button to turn your projector off.

*NOTE: To turn off the projector, press and hold the POWER OFF button for a minimum of two seconds.*

#### 7. VIDEO Button

Press this button to toggle between Video and S-Video inputs.

#### 8. RGB Button

Press this button to select RGB, DVI (DIGITAL) or DVI (ANALOG) inputs. Each time this button is pressed, the input source will change as follows:

RGB → DVI (DIGITAL) → DVI (ANALOG) → RGB → ...

#### 9. VIEWER Button

Press this button to select the Viewer source.

#### 10. AUTO ADJ. Button

Use this button to adjust an RGB source for an optimal picture.

#### 11. LASER Button

Press and hold this button to activate the laser pointer. When lit, you can use the laser to draw your audience's attention to a red dot that you can place on any object.

#### 12. MENU Button

Displays the menu for various settings and adjustments.

#### 13. SELECT ▲▼◀▶ (Mouse) Button

When you are in the Computer mode, these buttons work as a computer mouse.

When you are in the Projector mode, which is indicated by lighting the PJ button. See page 4-1.

▲▼ : Use these buttons to select the menu of the item you wish to adjust.

◀▶ : Use these buttons to change the level of a selected menu item. A press of the ▶ button executes the selection.

When the pointer is displayed, these ▲▼◀▶ buttons move the pointer.

When the pointer is not displayed, these ▲▼◀▶ buttons are for adjusting the image.

#### 14. ENTER (Left Click) Button

When you are in the Computer mode, this button works as the mouse left button. When this button is pressed and held for a minimum of two seconds, the drag mode is set. When you are in the Projector mode, which is indicated by lighting the PJ button: Use this button to enter your menu selection. It works the same way as the ENTER button on the cabinet. See page 4-1 for the Computer mode.

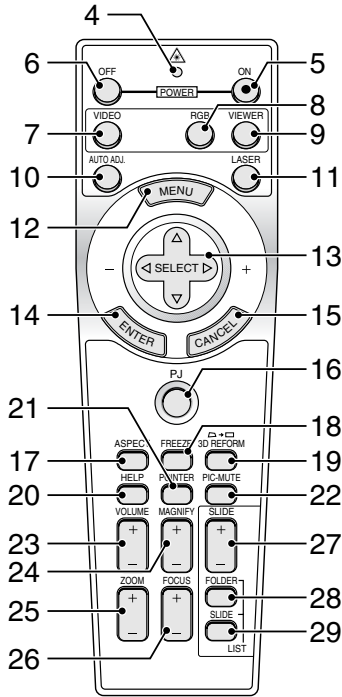

**15. CANCEL (Right Click) Button**

When you are in the Computer mode, this button works as the mouse right button. When you are in the Projector mode, which is indicated by lighting the PJ button: Press this button to exit the Menus. It works the same way as the CANCEL button on the cabinet. See page 4-1 for the Computer mode.

**16. PJ Button**

Press this button to switch the SELECT, CANCEL, and ENTER buttons between the Projector mode (lit red) and the Computer mode. Press this button or any one of the POWER ON/OFF, MENU, ASPECT, 3D REFORM, HELP, POINTER, MAGNIFY, VIEWER, FOLDER LIST or SLIDE LIST buttons to switch to the Projector mode and the PJ button lights red. To switch back to the Computer mode, press the PJ button again. See page 4-1.

**17. ASPECT Button**

Press this button to display the Aspect Ratio select screen. See page 6-8.

**18. FREEZE Button**

This button will freeze a picture. Press again to resume motion.

**19. 3D REFORM Button**

Press this button to enter 3D Reform to correct the distortion, and make the image square. See page 6-10. Each time this button is pressed, the item will change as follows:

Pincushion → Cornerstone → Keystone → ... (the three items are available only when no adjustment is made)

**20. HELP Button**

Provides the online help or the set information.

**21. POINTER Button**

Press this button to display pointers; press again to hide the pointer. You can move your pointer icon to the area you want on the screen using the Select ▲▼◀▶ button. See page 4-2.

**22. PIC-MUTE Button**

This button turns off the image and sound for a short period of time. Press again to restore the image and sound.

*NOTE: When the menu is displayed, a press of this button mutes an image and sound without turning off the menu.*

**23. VOLUME (+)(-) Button**

Press (+) to increase the volume and (-) to decrease it.

**24. MAGNIFY (+)(-) Button**

Use this button to adjust the image size up to 400%. When the pointer is displayed, the image is magnified about the center of the pointer.

When the image is magnified, the pointer is changed to the magnifying icon.

When the pointer is not displayed, the image is magnified about the center of the screen. See page 4-3.

**25. ZOOM (+)(-) Button**

Reduces the image size between 80% and 100%.

**26. FOCUS (+)(-) Button**

Adjust the focus.

**27. SLIDE (+)(-) Button**

Press (+) to select the next folder or slide and (-) to select the previous folder or slide. See page 5-2.

**28. FOLDER LIST Button**

Press this button to display a list of folders included in a PC card. See page 5-2.

**29. SLIDE LIST Button**

Press this button to display a list of slides included in a PC card. See page 5-2.

*NOTE: The default is the Computer mode, which allows you to use the SELECT, CANCEL, and ENTER buttons as your computer mouse. When the POWER ON/OFF, MENU, ASPECT, 3D REFORM, HELP, POINTER, MAGNIFY, VIEWER, FOLDER LIST, or SLIDE LIST button is pressed, the PJ button lights red to indicate that you are in the Projector mode. If no buttons are pressed within 60 seconds, the light goes out and the Projector mode is canceled.*

**Battery Installation**

1. Press the catch and remove the battery cover.

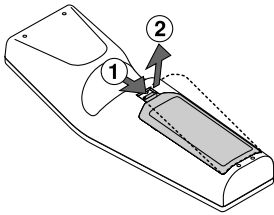

2. Remove both old batteries and install new ones (AA). Ensure that you have the batteries' polarity (+/-) aligned correctly.

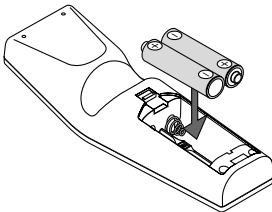

3. Slip the cover back over the batteries until it snaps into place. Do not mix different types of batteries or new and old batteries.

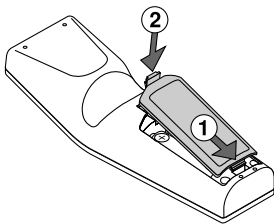

**Note on Battery Installation:**

If you press and hold the SELECT ▲▼◀▶ button while installing new batteries, the remote control may fail to work properly. Should this happen, remove the batteries and then install them again without touching the SELECT button.

**Remote Control Precautions**

- Handle the remote control carefully.
- If the remote control gets wet, wipe it dry immediately.
- Avoid excessive heat and humidity.
- If you will not be using the remote control for a long time, remove the batteries.
- Do not place the batteries upside down.
- Do not use new and old batteries together, or use different types of batteries together

**Operating Range for Wireless Remote Control**

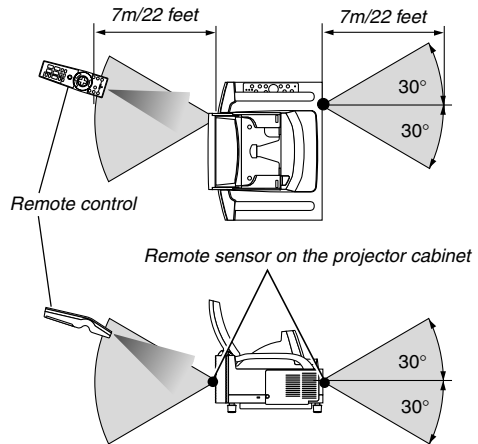

- The infrared signal operates by line-of-sight up to a distance of about 22 feet/7 m and within a 60-degree angle of the remote sensor on the projector cabinet.
- The projector will not respond if there are objects between the remote control and the sensor, or if strong light falls on the sensor. Weak batteries will also prevent the remote control from properly operating the projector.

**Using the Remote Control in Wired Operation**

Connect one end of the supplied remote cable to the REMOTE mini jack and the other end to the remote jack on the remote control.

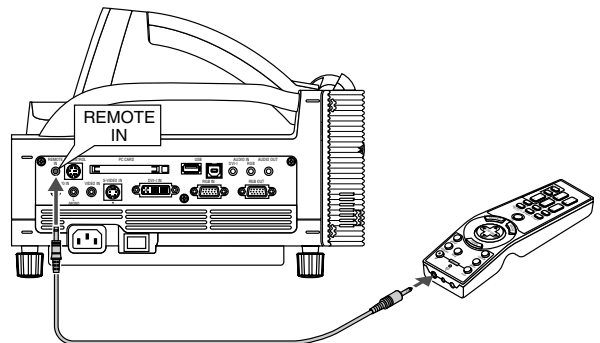

*NOTE: When the remote cable is inserted into the REMOTE IN jack, the projector's status is changed from the Standby mode to the Idle mode.*

## 2. Installation and Connections

---

This section describes how to set up your projector and how to connect video and audio sources.



When installing the projector for the first time, read the WT600 Setup Guide carefully.

**Your projector is simple to set up and use.**

But before you get started you must first:

**1. Set up a screen and the projector.**

---

*NOTE: Using a warped screen can cause an image to appear distorted.*

---

**2. Connect your computer or video equipment to the projector. See page 2-3 to 2-7.**

**3. Connect the supplied power cable. See page 2-7.**

---

*NOTE: Ensure that the power cable and any other cables are disconnected before moving the projector. When moving the projector or when it is not in use, close the mirror cover on the top cabinet.*

---

## 2-1. Setting Up the Screen and the Projector

### Selecting a Location

The further your projector is from the screen or wall, the larger the image. The minimum size the image can be is approximately 40" (1.0 m) measured diagonally when the projector is roughly 2.5 inches (64mm) from the wall or screen. The largest the image can be is 100" (2.54m) when the projector is about 26 inches (660mm) from the wall or screen. Use the drawing below as a guide.

### Screen Dimensions

Screen size (inch)	Width (inch)	Width (mm)	Height (inch)	Height (mm)
40	32.0	813	24.0	610
45	36.0	914	27.0	686
50	40.0	1016	30.0	762
55	44.0	1118	33.0	838
60	48.0	1219	36.0	914
65	52.0	1321	39.0	991
67	53.6	1361	40.2	1021
70	56.0	1422	42.0	1067
72	57.6	1463	43.2	1097
75	60.0	1524	45.0	1143
78	62.4	1585	46.8	1189
80	64.0	1626	48.0	1219
84	67.2	1707	50.4	1280
85	68.0	1727	51.0	1295
90	72.0	1829	54.0	1372
95	76.0	1930	57.0	1448
96	76.8	1951	57.6	1463
100	80.0	2032	60.0	1524

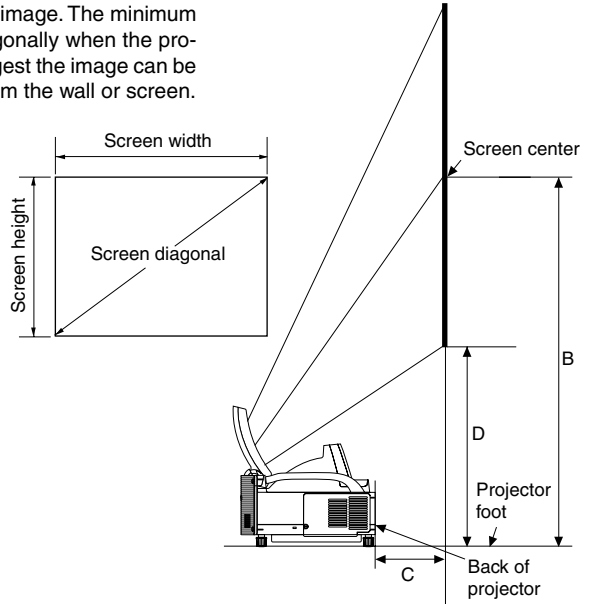

### Throw Distance, Screen Size and Screen Height (Unit: mm)

Screen size (inch)	Throw distance (mm)		Height (mm)	
	C	B	D	
40	64	659	354	
45	114	729	386	
50	164	799	418	
55	214	869	450	
60	263	939	482	
65	313	1010	514	
67	332	1037	526	
70	362	1080	546	
72	381	1107	558	
75	412	1149	577	
78	441	1191	596	
80	461	1219	609	
84	500	1275	635	
85	510	1289	641	
90	559	1359	673	
95	609	1428	704	
96	619	1443	711	
100	659	1499	737	

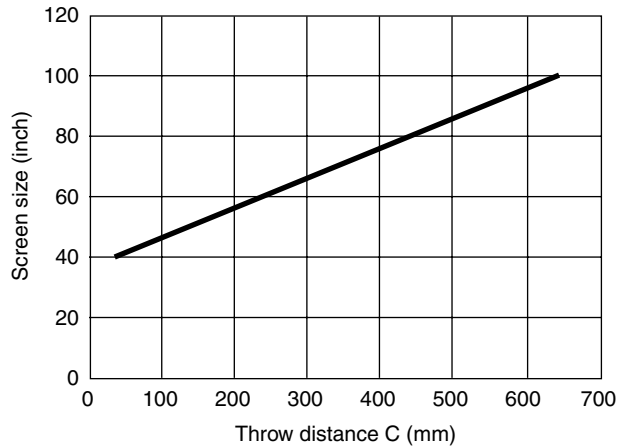

### Throw Distance, Screen Size and Screen Height (Unit: inch)

Screen size (inch)	Throw distance (inch)		Height (inch)	
	C	B	D	
40	2.5	25.9	13.9	
45	4.5	28.7	15.2	
50	6.4	31.5	16.5	
55	8.4	34.2	17.7	
60	10.4	37.0	19.0	
65	12.3	39.7	20.2	
67	13.1	40.8	20.7	
70	14.3	42.5	21.5	
72	15.0	43.6	22.0	
75	16.2	45.2	22.7	
78	17.4	46.9	23.5	
80	18.1	48.0	24.0	
84	19.7	50.2	25.0	
85	20.1	50.7	25.2	
90	22.0	53.5	26.5	
95	24.0	56.2	27.7	
96	24.4	56.8	28.0	
100	25.9	59.0	29.0	



## 2-2. Making Connections

*NOTE: When using with a notebook PC, be sure to connect between the projector and the notebook PC before turning on the power to the notebook PC. In most cases signal cannot be output from RGB output unless the notebook PC is turned on after connecting with the projector.  
 \* If the screen goes blank while using your notebook PC, it may be the result of the computer's screen-saver or power management software.  
 \* If you accidentally hit the POWER button on the remote control, wait 90 seconds and then press the POWER button again to resume.*

### When Viewing a DVI Digital Signal:

To project a DVI digital signal, be sure to connect the PC and the projector using the DVI-D signal cable (supplied) before turning on your PC or projector. Turn on the projector first and select DVI (DIGITAL) from the source menu before turning on your PC. Failure to do so may not activate the digital output of the graphics card resulting in no picture being displayed. Should this happen, restart your PC. Do not disconnect the DVI-D signal cable while the projector is running. If the signal cable has been disconnected and then re-connected, an image may not be correctly displayed. Should this happen, restart your PC.

**NOTE:**

- Use the supplied DVI-D cable or the one compliant with DDWG (Digital Display Working Group) DVI (Digital Visual Interface) revision 1.0 standard. The DVI-D cable should be within 5 m (196") long.
- The DVI (DIGITAL) connector accepts VGA (640x480), SVGA (800x600), 1152x864, XGA (1024x768) and SXGA (1280x1024 @ up to 60Hz).

### Connecting Your PC or Macintosh Computer

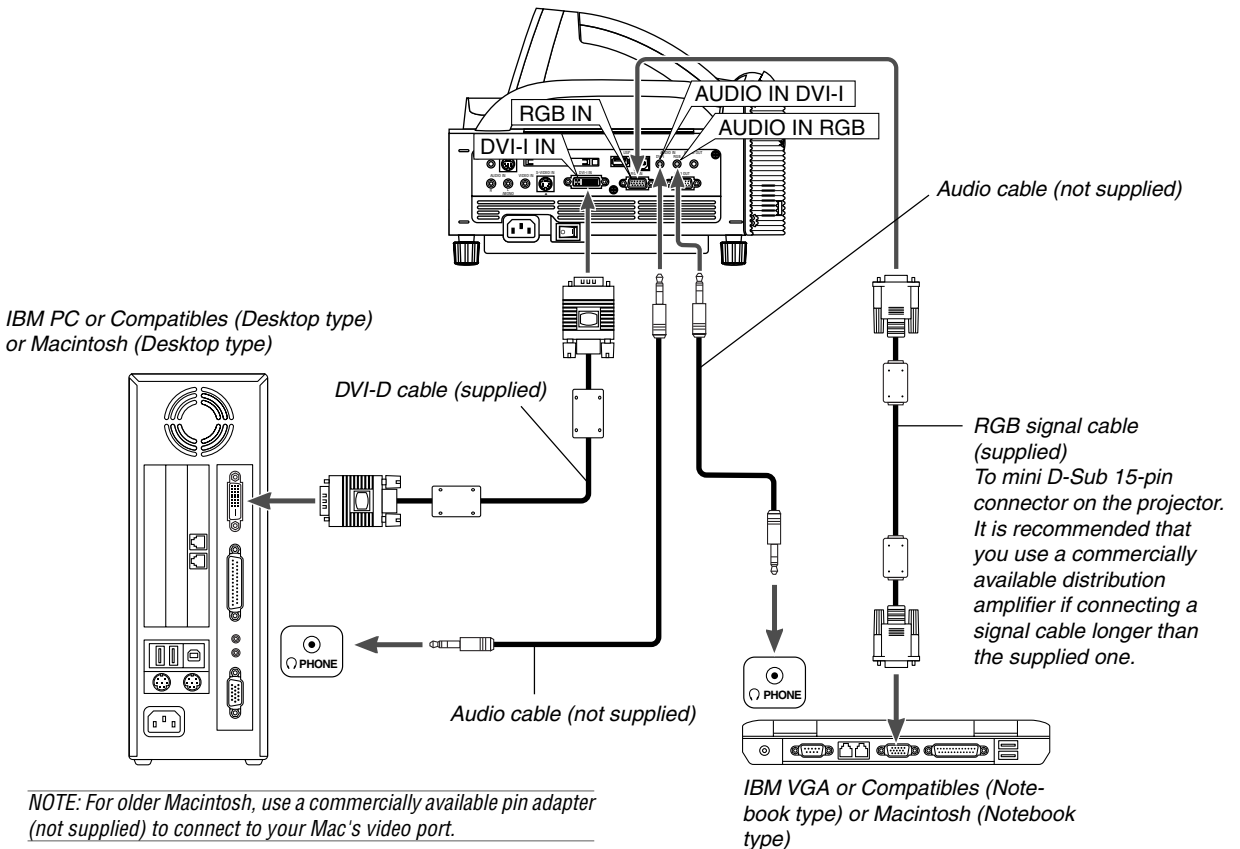

### Connecting Your PC with a DVI Connector

Use a DVI-D signal cable (supplied) to connect a DVI connector of your PC to the projector.

*NOTE: The WT600 is not compatible with video decoded outputs of NEC ISS-6020 and ISS-6010.*

### To connect SCART output (RGB)

Before connections: An exclusive SCART adapter (ADP-SC1) and a commercially available SCART cable are required for this connection.

*NOTE: Audio signal is not available for this connection.*

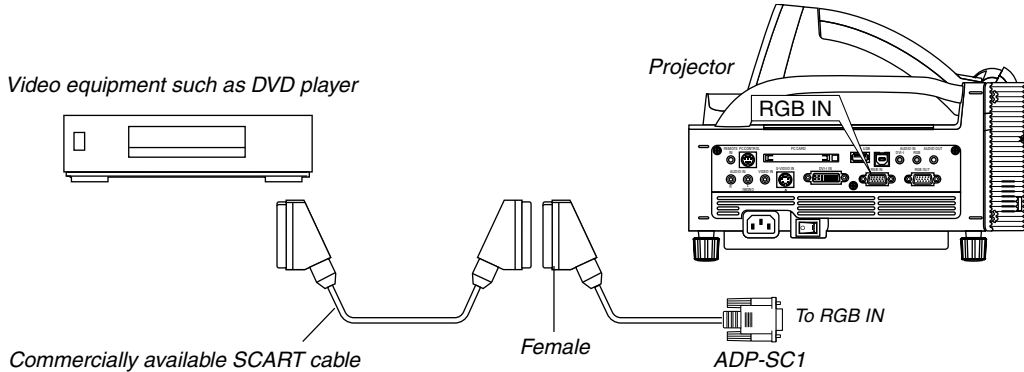

1. Turn off the power to the projector and your video equipment.
  2. Use the NEC ADP-SC1 SCART adapter and a commercially available SCART cable to connect the RGB input of your projector and a SCART output (RGB) of your video equipment.
  3. Turn on the power to the projector and your video equipment.
  4. Use the RGB button on the remote control to select the RGB input.
  5. Press the MENU button on the remote control to display the menu.
  6. From the Advanced menu, select [Projector Options] → [Setup] → [Page 3] → [Signal Select RGB] → [Scart].
- SCART is a standard European audio-visual connector for TVs, VCRs and DVD players. It is also referred to as Euro-connector.

*NOTE: The ADP-SC1 SCART adapter is obtainable from your NEC dealer in Europe. Contact your NEC dealer in Europe for more information.*

### Using two RGB inputs simultaneously

If you need to use two RGB inputs simultaneously, connect the supplied DVI-A to VGA cable as shown below.

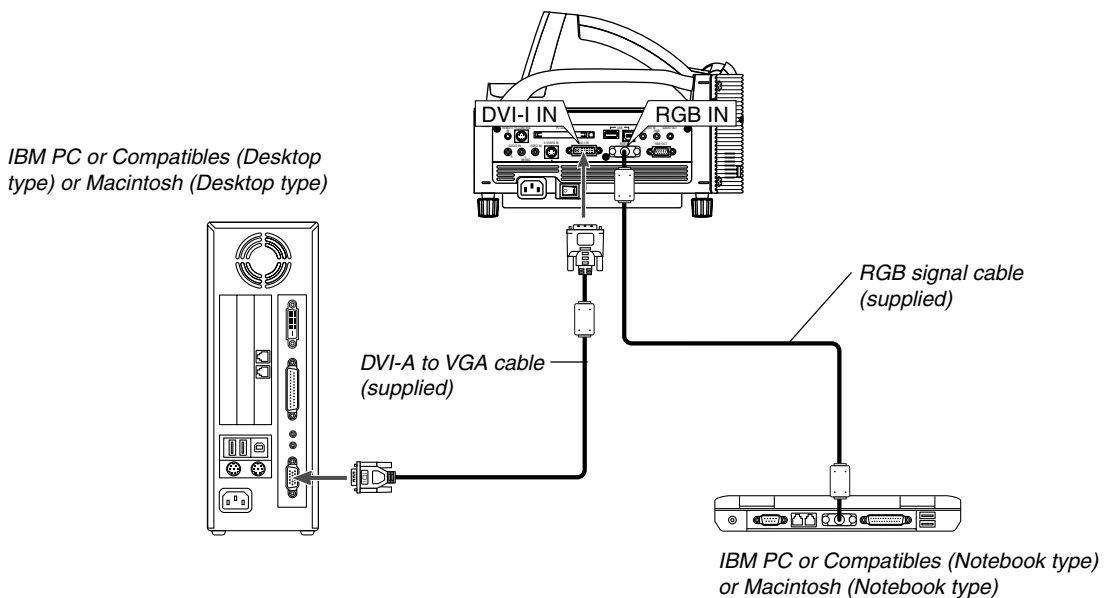



### Connecting an External Monitor

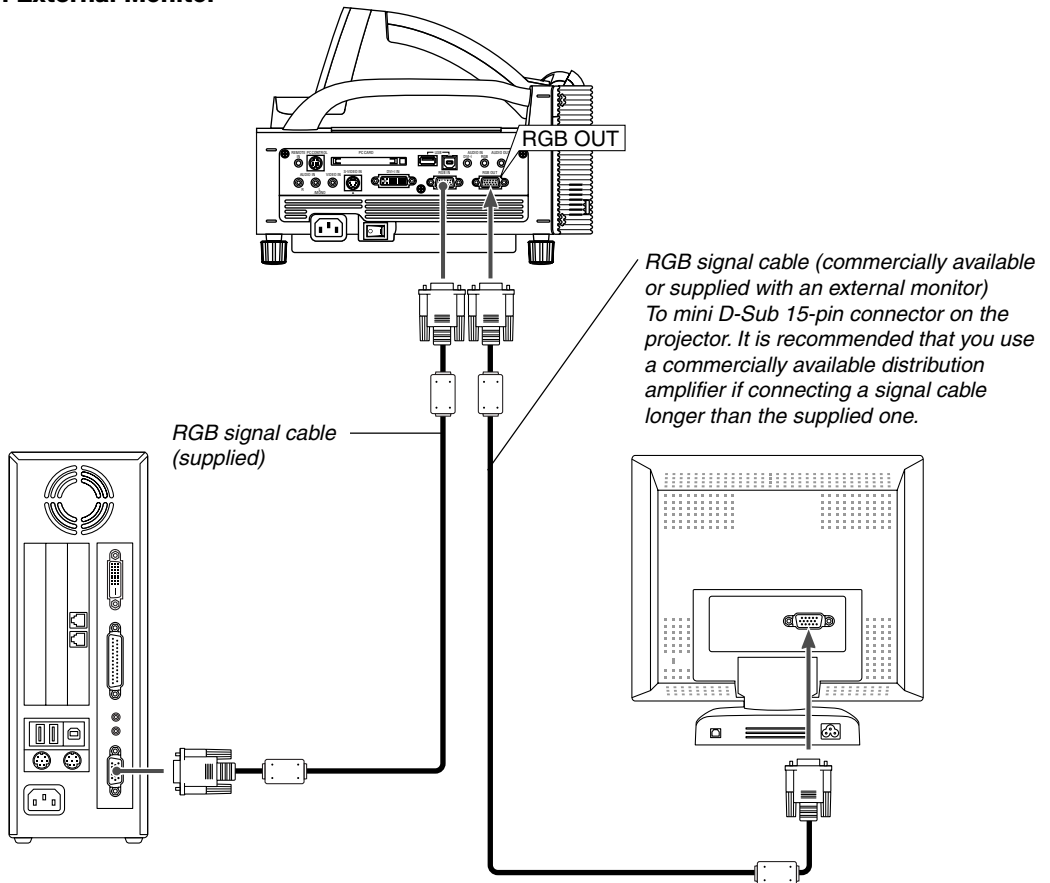

You can connect a separate, external monitor to your projector to simultaneously view on a monitor the RGB analog image you're projecting. To do so:

1. Turn off the power to your projector, monitor and computer.
2. Use a 15-pin cable to connect your monitor to the RGB OUT (Mini D-Sub 15 pin) connector on your projector.
3. Turn on the projector, monitor and the computer.

**NOTE:**

- The RGB OUT connector can output RGB signal even during idle mode (See page 6-17 for enabling the Idle mode). When the projector goes into idle mode, the image on an external monitor disappears for a moment. Note that the RGB OUT connector will not output RGB signal during Standby mode.
- When the projector is in the Idle mode, the image may not be correctly displayed while the cooling fans are running immediately after turning on or off the power. Note that the RGB OUT connector will not output RGB signal during Standby mode.
- Daisy chain connection is not possible.

Connecting Your DVD Player

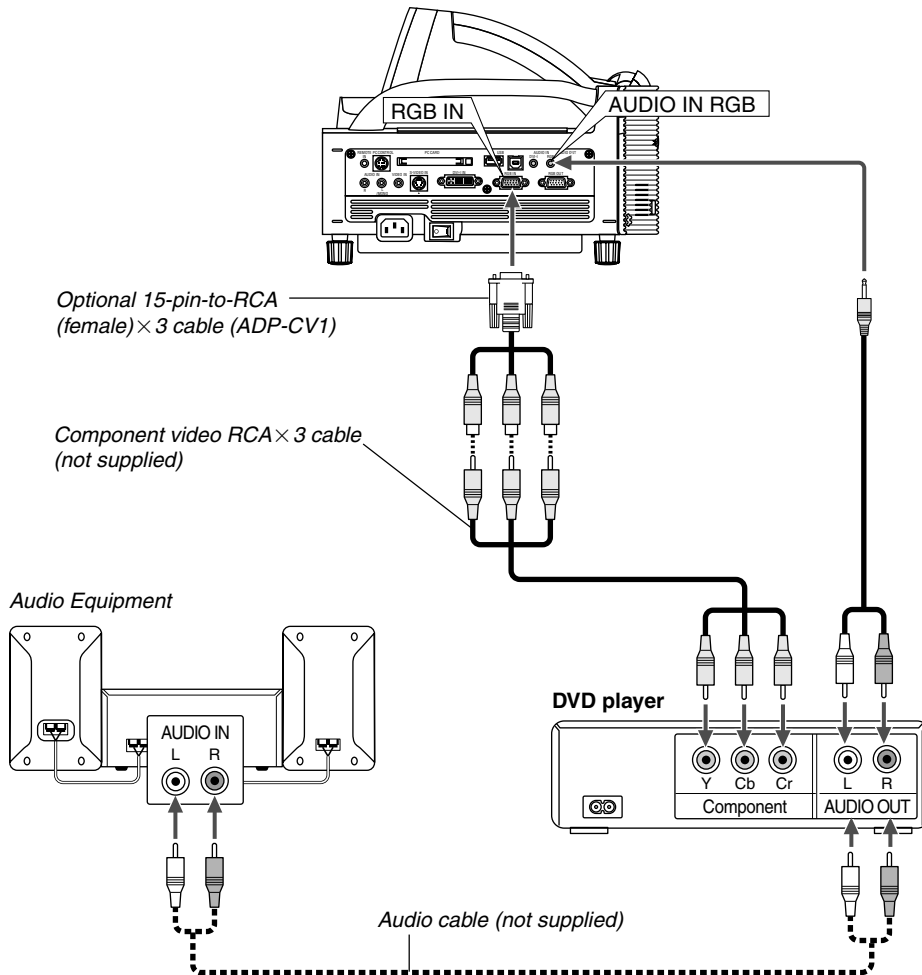

You can connect your projector to a DVD player with component output or Video output. To do so, simply:

1. Turn off the power to your projector and DVD player.
2. If your DVD player has the component video (Y,Cb,Cr) output, use a commercially available component video cable (RCA X3) and the optional 15-pin-to-RCA (female) × 3 cable to connect your DVD player to the RGB IN connector on the projector. For a DVD player without component video (Y,Cb,Cr) output, use common RCA cables (not provided) to connect a composite VIDEO output of the DVD player to the Video Input of the projector.
3. Turn on the projector and DVD player.

*NOTE: Refer to your DVD player's owner's manual for more information about your DVD player's video output requirements.*

**Connecting Your VCR or Laser Disc Player**

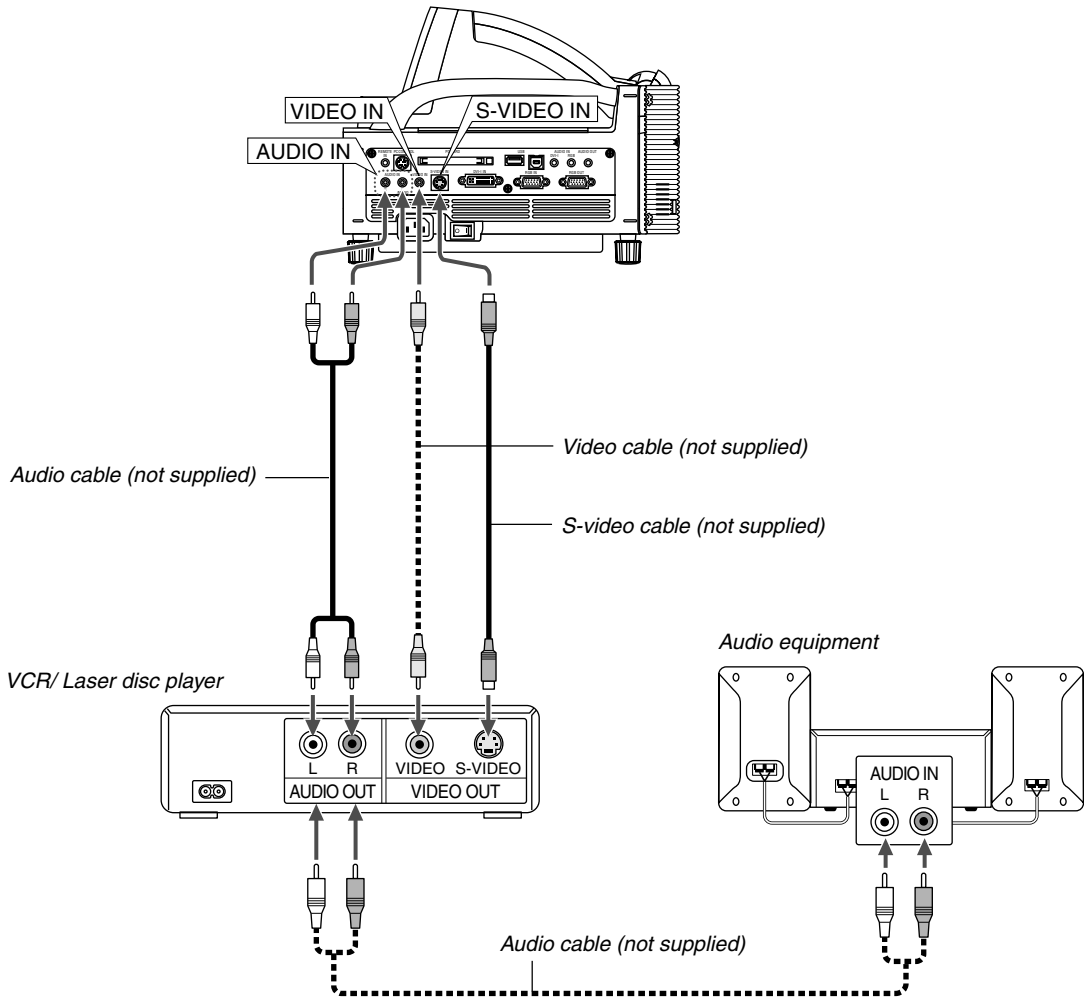

Use common RCA cables (not provided) to connect your VCR, laser disc player or document camera to your projector. To make these connections, simply:

1. Turn off the power to the projector and VCR, laser disc player or document camera.
2. Connect one end of your RCA cable to the video output connector on the back of your VCR or laser disc player, connect the other end to the Video input on your projector. Use an audio cable (not supplied) to connect the audio from your VCR or laser disc player to your audio equipment (if your VCR or laser disc player has this capability). Be careful to keep your right and left channel connections correct for stereo sound.

3. Turn on the projector and the VCR or laser disc player.

*NOTE: Refer to your VCR or laser disc player owner's manual for more information about your equipment's video output requirements.*

*NOTE: An image may not be displayed correctly when a Video or S-Video source is played back in fast-forward or fast-rewind via a scan converter.*

**Connecting the Supplied Power Cable**

Connect the supplied power cable to the projector. First connect the supplied power cable's three-pin plug to the AC IN of the projector, and then connect the other plug of the supplied power cable in the wall outlet.

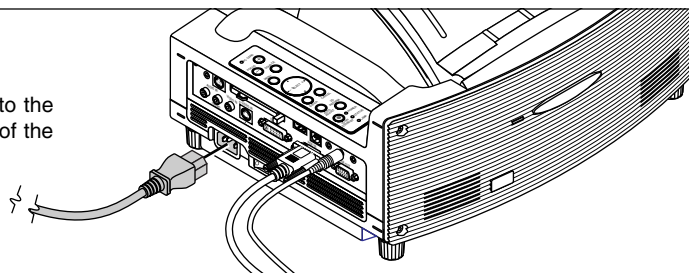

# 3. Projecting an Image (Basic Operation)

This section describes how to turn on the projector and to project a picture onto the screen.

## 3-1. Turning on the Projector

**NOTE:**

- When plugging in or unplugging the supplied power cable, make sure that the main power switch is pushed to the off[O] position. Failure to do so may cause damage to the projector.
- The projector has two power switches: main power switch and POWER button (POWER ON and OFF on the remote control)
- The projector has a feature to prevent itself from being used by unauthorized individuals. To use this feature, register your PC card as a protect key. See "Security" in "Projector Options" on page 6-23 for more details.

To turn on the main power to the projector, press the Main Power switch to the ON position ( I ).

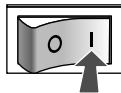

Before you turn on your projector, ensure that the computer or video source is turned on and that the mirror cover is open. Only after you press the ON/STAND BY button on the projector cabinet or POWER ON button on the remote control for a minimum of two seconds will the power indicator turn to green and the projector become ready to use.

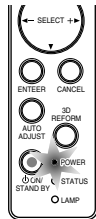

### Note on Startup screen (Menu Language Select screen)

When you first turn on the projector, you will get the Startup screen. This screen gives you the opportunity to select one of the seven menu languages: English, German, French, Italian, Spanish, Swedish and Japanese.

To select a menu language, follow these steps:

1. Use the SELECT ▲ or ▼ button to select one of the seven languages for the menu.



2. Press the ENTER button to execute the selection.



3. The Basic menu will be displayed in the language you have selected.

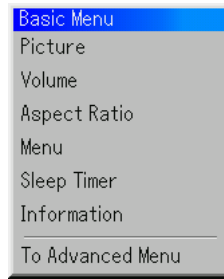

To close the menu, press the CANCEL button.

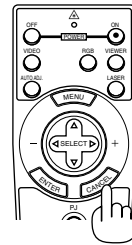

After this has been done, you can proceed to the advanced menu operation. If you want, you can select the menu language later. See "Language" on page 6-14.

**NOTE:** To turn the projector on by plugging in the power cable, first turn on the Main Power switch to ON and use the menu and enable the "Auto Start" feature. (See page 6-16.) Immediately after turning on the projector, screen flicker may occur. This is not a fault. Wait 3 to 5 minutes until the lamp lighting is stabilized.

When the Lamp mode is set to Eco, the Lamp indicator will light green.

If one of the following things happens, the projector will not turn on.

- \* If the internal temperature of the projector is too high, the projector detects abnormal high temperature. In this condition the projector will not turn on to protect the internal system. If this happens, wait for the projector's internal components to cool down.
- \* When the lamp reaches its end of usable life, the projector will not turn on. If this happens, replace the lamp.
- \* If the lamp fails to light, and if the STATUS indicator flashes on and off in a cycle of six times, wait a full minute and then turn on the power.
- \* When the mirror cover is closed.
- \* If the temperature sensor detects excessive heat in the bottom of the mirror or in the light path, the projector will not turn on. Remove objects such as dust from the bottom of the mirror.
- \* The projector has a sensor which detects an object in front of the largest mirror or in the light path. If the sensor detects any object, the projector will not turn on. Remove the object.
- \* Do not illuminate the projector with strong light source such as halogen lamp. Doing so can cause the object detection sensor to malfunction, resulting in the projector not turning on.

### 3-2. Selecting a Source

#### Selecting the computer or video source

Using the Remote Control

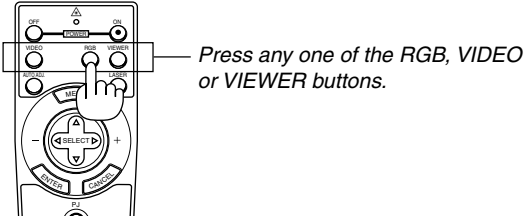

*NOTE: If no input signal is available, the projector will display a blue background (factory preset).*

#### Selecting from Source List

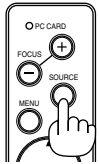

Press and quickly release the SOURCE button on the projector cabinet to display the Source list. Each time the SOURCE button is pressed, the input source will change as follows: "RGB" (computer or DVD with component output), "DVI (DIGITAL)", "DVI (ANALOG)", "Video" (VCR, document camera, or laser disc player), "S-Video", "Viewer" (slides on a PC card), or "LAN" (wired or wireless signal aired from a PC). To display the selected source, press the ENTER button.

#### Detecting the Signal Automatically

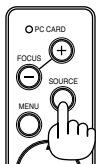

Press and hold the SOURCE button for a minimum of 1 second, the projector will search for the next available input source. Each time you press and hold the SOURCE button, the input source will change as follows:

RGB → DVI (DIGITAL) → DVI (ANALOG) → Video → S-Video → Viewer → ...

If no input signal is present, the input will be skipped. When the input source you wish to project is displayed, release the button. Press the ENTER button.

### 3-3. Adjusting the Picture Size and Position

**1. Place the projector on a flat level surface and ensure that the projector is square to the screen.**

**2. Make the image square**

Move the projector left or right to center the image horizontally on the screen.

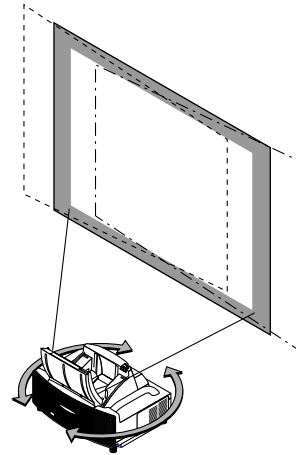

**3. Adjust the projected image size**

Use the throw chart on page 2-2 to adjust the image size.

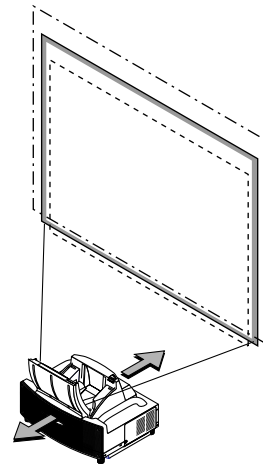

**4. Finely adjust the height to keep the projector level**

To finely adjust the height, use the feet on the front or rear.

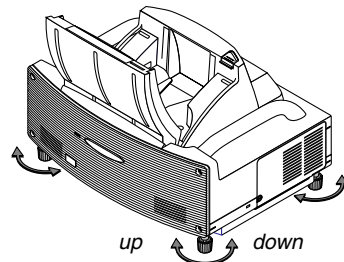

Each of the feet height can be changed up to 1.2" (30 mm).

### 3. Projecting an Image (Basic Operation)

#### 5. Adjust the focus

Use the FOCUS <+/-> button on the remote control or the projector cabinet to reduce keystone distortion. When the top edge of an image is shorter than the bottom one, press the FOCUS + button to correct the distortion. Focus adjustment will slightly change the picture position. If required, reposition the projector.

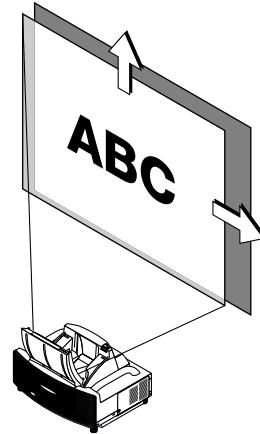
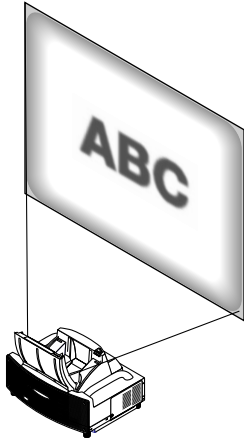

#### NOTE:

- The "Horizontal/Vertical Position" option can be adjusted within a range of 100%.

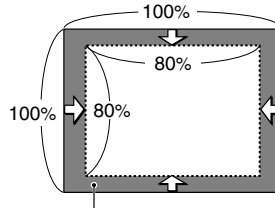

Adjustable zoom area

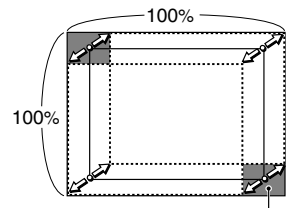

Movable area of displayed image

- When any adjustment is made to the "Cornerstone" or "Keystone" option, the "Digital Zoom" option is not available.
  - \* The Digital Zoom option may blur an image because the image is electronically compressed.
  - \* The Digital Zoom option can reduce the image down to 80% of its original size while keeping aspect ratio the same as the original.

#### 6. Repeat the above steps if required.

#### 7. Reduce the image (Digital Zoom)

You can reduce and move the projected image. Press the ZOOM button on the remote control to display the Digital Zoom menu. Use the ▲ or ▼ to select the Reduction Ratio, Horizontal Position or Vertical Position.

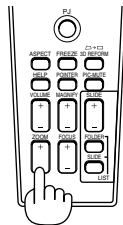
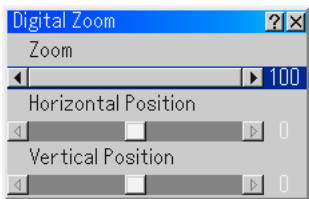

#### Zoom

You can reduce the image size between 80% and 100% using the ZOOM button (+/-).

#### Horizontal Position

Use the ◀ or ▶ to move the picture right or left.

#### Vertical Position

Use the ▲ or ▼ to adjust the picture up or down.

#### 8. Correct distortion.

Use the 3D Reform button on the remote control or the projector cabinet to correct the distortion. See page 6-10 for more information.

### 3-4. Optimizing RGB Picture Automatically

#### Adjusting the Image Using Auto Adjust

Optimizing RGB image automatically

Press the Auto Adjust button to optimize an RGB image automatically.

[Poor picture]

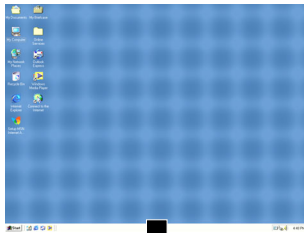
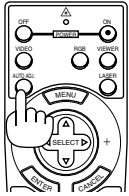

[Normal picture]

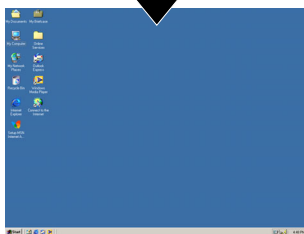

Press the Auto Adjust button to fine-tune the computer image or to remove any vertical banding that might appear and to reduce video noise, dot interference or cross talk (this is evident when part of your image appears to be shimmering). This function adjusts the clock frequencies that eliminate the horizontal banding in the image. This function also adjusts the clock phase to reduce video noise, dot interference or cross talk. (This is evident when part of your image appears to be shimmering.) This adjustment may be necessary when you connect your computer for the first time.

**NOTE:**

- Some signals may not be displayed correctly or take time.
- The Auto Adjust function does not work for component and video signal.
- If the Auto Adjust operation cannot optimize the RGB signal, try to adjust Clock and Phase manually. See page 6-8.

### 3-5. Turning Up or Down Volume

Sound level from the speaker and the AUDIO OUT jack (RCA) on the projector can be adjusted.

increase volume

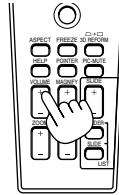

decrease volume

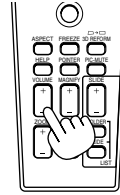

Volume bar



### 3-6. Using the Laser Pointer

You can use the laser to draw your audience's attention to a red dot that you can place on any object.

Press and hold the LASER button to activate the laser pointer.

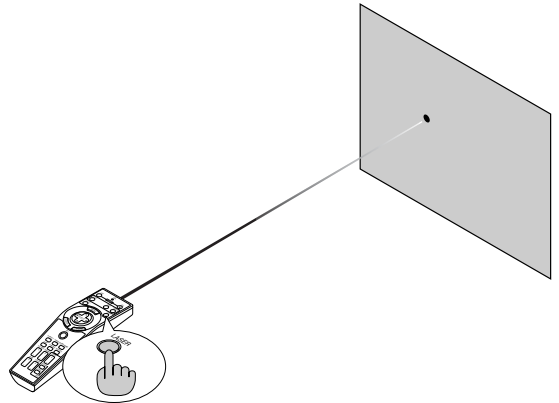

**CAUTION:**

- Do not look into the laser pointer while it is on.
- Do not point the laser beam at a person.

#### Setting the function switch

There are two switches on the bottom of the battery case: an applicable projector selector switch (1) and laser enable/disable switch (2). On this model, an applicable projector selector switch (1) is not used. Decide whether to enable or disable laser, then set this switch as necessary using the tip of a thin ball-point pen.

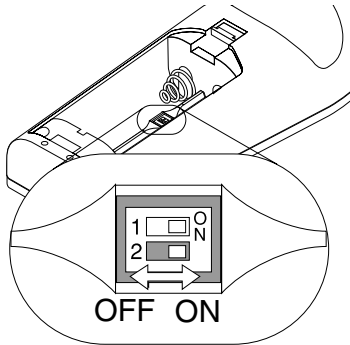

Switch (2)

- On: Enabled (the laser lights when the LASER button is pressed) [Factory default]
- Off: Disabled (the laser does not light even when the LASER button is pressed)

Disable the laser when using in an environment in which the unit is accessible to children.

### 3-7. Turning off the Projector

#### To turn off the projector:

First press the POWER (ON/STAND BY) button on the projector cabinet or the POWER OFF button on the remote control for a minimum of two seconds. The power indicator will glow orange. After the projector turns off, the cooling fans keep operating for 90 seconds (Cooling-off time). Second, turn off the Main Power switch. The power indicator will go out. Lastly unplug the power cable.

#### CAUTION

Do not unplug the power cable from the wall outlet or do not turn off the main power under any one of the following circumstances. Doing so can cause damage to the projector:

- While the Hour Glass icon appears.
- While the message "Please wait a moment." appears. This message will be displayed after the projector is turned off.
- While the cooling fans are running. (The cooling fans continue to work for 90 seconds after the projector is turned off).
- While accessing a PC card. (The PC Card Access indicator lights.)

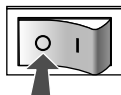



# 4. Convenient Features

## 4-1. Using the Remote Mouse Function

The built-in remote mouse function enables you to operate your computer's mouse functions from the remote control (Computer mode). It is a great convenience for clicking through your computer-generated presentations. To return to the projector operation mode (Projector mode), press the PJ button (lit red).

### Connecting to your computer for the remote mouse function

If you wish to use the remote mouse function, use the supplied USB cable to connect the USB port (PC) of the projector and the USB port (type A) of your computer.

*NOTE: Depending on the type of connection or OS installed on your computer, you may have to restart your computer or change your computer settings.*

### When using the USB Port

For PC, the mouse receiver function can only be used with a Windows 98, Windows ME, Windows XP or Windows 2000 operating system.

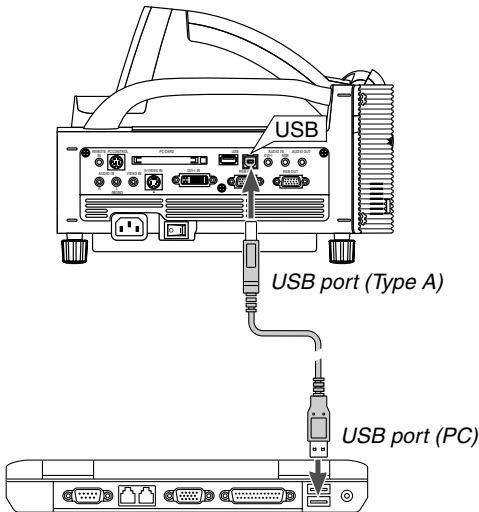

*NOTE: Wait at least 5 seconds after disconnecting the USB cable before reconnecting it and vice versa. The computer may not identify the built-in mouse receiver if it is repeatedly connected and disconnected in rapid intervals.*

### Switching operation mode between computer and projector

The three shaded buttons shown on the drawing work as a computer mouse in the Computer mode.

In the Computer mode the PJ button is not lit.

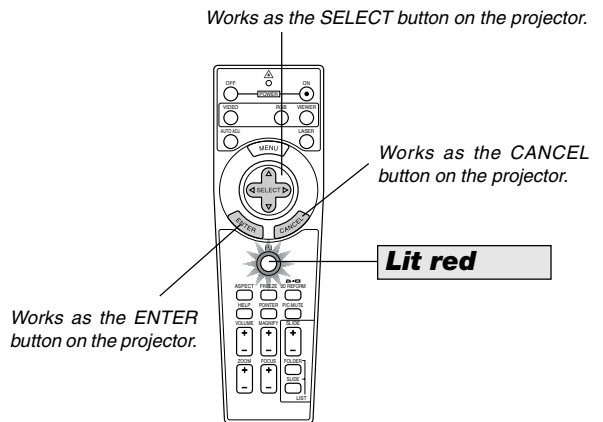
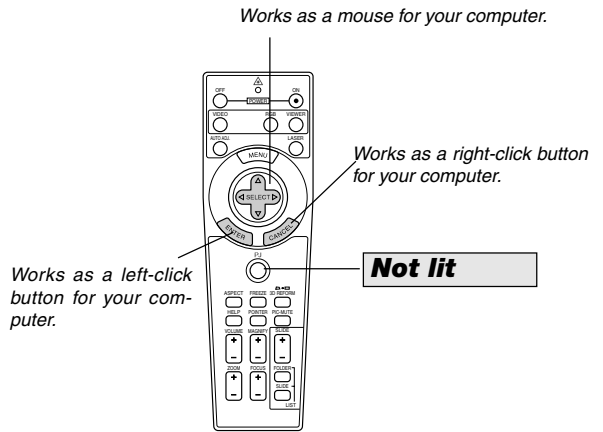

- When the MENU button is pressed, the PJ button lights red to indicate that you are in the Projector mode, which allows the projector menu operation using the three buttons.
- When the POINTER button is pressed, the PJ button lights red to indicate that you are in the Projector mode and that the SELECT ▲▼◀▶ button works as a moving button for the POINTER or magnified image.
- If no buttons are pressed within 60 seconds, the PJ button's light goes out to indicate that you are in the Computer mode. To enable the projector menu operation again, press the PJ button to light red. To move the pointer or a magnified image again, turn off the pointer and then turn on the pointer (press the POINTER button two times).
- When the PJ button is lit, if you want to use the mouse function immediately, press the PJ button to return to the Computer mode (not lit).

**During Computer mode:**

In Computer mode, by pressing the ENTER button for 2 seconds or more then releasing, the drag mode is set and the drag operation can be performed simply by pressing the SELECT ▲▼◀▶ (mouse) button. To drop the item, press the ENTER (left click) button again or press the CANCEL (right click) button.

**4-2. Turning Off the Image and Sound**

Press the PIC-MUTE button to turn off the image and sound for a short period of time. Press again to restore the image and sound.



**4-3. Freezing a Picture**

Press the FREEZE button to freeze a picture. Press again to resume motion.

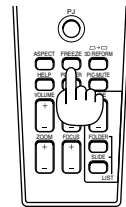

**4-4. Using the Pointer**

You can use one of nine pointers to draw your audience's attention to the portion of a projected image you want.

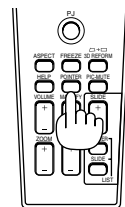
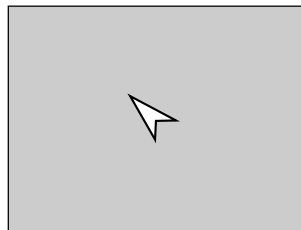

*Press the POINTER button to display the pointer.*

Press the POINTER button to display the pointer.

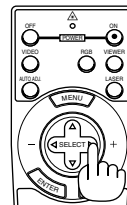
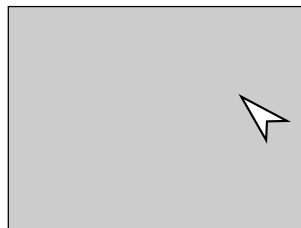

*Use the SELECT button to move the pointer.*

Use the SELECT button to move the pointer.  
Press the POINTER button again to hide the pointer.

### 4-5. Enlarging and Moving a Picture

You can enlarge the area you want up to 400 percent. To do so:

1. Press the **POINTER** button to display the pointer.

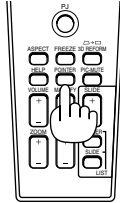
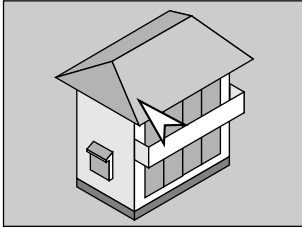

2. Move the pointer to the area you want to enlarge.

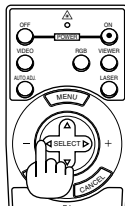
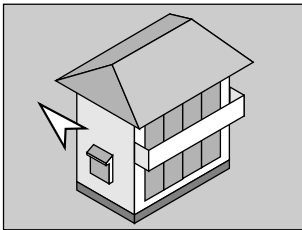

3. Enlarge the selected area.

When the **MAGNIFY (+)** button is pressed, the image is magnified. To move the magnified image, use the **SELECT** button.

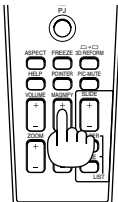
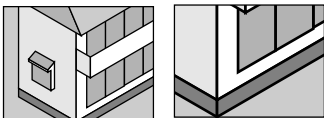

4. Return the image to the original size.

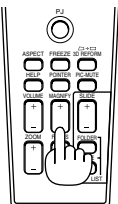
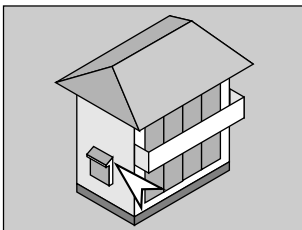

### 4-6. Getting the On-line Help

You get the contents about Help.

Display Help

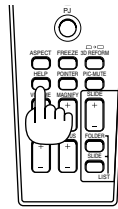

Exit Help

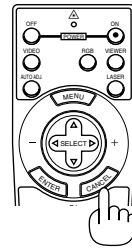

### 4-7. Using a USB Mouse

Using a USB mouse gives you a smooth operation. A commercially available USB mouse is required.

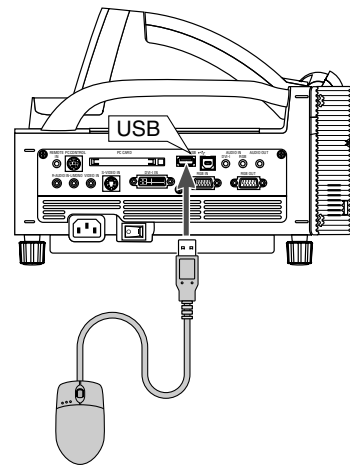

*NOTE: There may be some brands of USB mouse that the projector does not support. The scroll button on the supplied USB mouse does not work with the projector.*

#### Operate the Menus using the USB mouse

##### Mouse Cursor

When connecting a USB mouse to the projector, you get a mouse cursor on the screen.

Unless you use your USB mouse within 10 seconds, the mouse cursor disappears.

##### Menu Display

Clicking with a mouse button displays the menu.

Clicking **▶** displays the pull-down menu. To close the menu, click anywhere in the background.

##### Adjusting and Setting Display

You can select a menu item and click with a mouse button to make adjustments and setting.

**Examples**

Click (or press and hold) the mouse button ◀ or ▶ to adjust the brightness. Or click and drag the mouse button on the slide bar horizontally to adjust it.

To save the adjustments, click ✕. The display is closed. If you click anywhere in the background while displaying adjustment and setting menu or dialog box, you will return to the main menu.

**Using the middle button on the mouse**

The projector supports the middle button on your mouse. With the middle button you can use a scroll bar when it is available or click the middle button to display or hide the Chalkboard toolbar.

**4-8. Changing Background Logo**

You can change the default background logo using the PC Card Files feature.

*NOTE: File size must be 256KB or less. Other file formats than JPEG and BMP are not available.*

1. From the menu, select [Tools] → [PC Card Files] to display a list of all the files stored in the PC card so that you can select a file you want to use as a background logo.

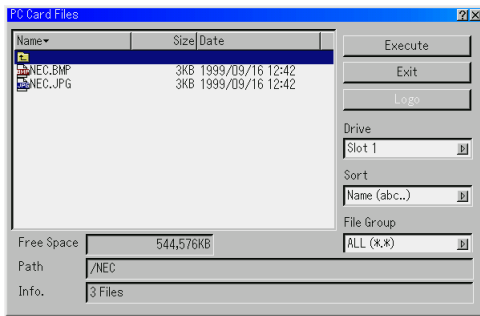

2. The Logo button allows you to select a background logo from graphic files on a PC card and change to it as the background logo.
3. Use the SELECT ▲ or ▼ button to select a JPEG or BMP file for your background logo.
4. Use the SELECT ▶ and then ▼ button to select "Logo".
5. Press the ENTER on the remote control or the cabinet. You will get the confirmation dialog box.

6. Select "OK" and press the ENTER button. This completes changing a logo for the background.



- \* Once you have changed the background from the NEC logo to another, you cannot return the logo to background even by using Factory Default. To do so, repeat the above steps. The NEC logo file is included on the supplied CD-ROM NEC Projector User Supportware (/Logo/nec\_b\_x.jpg).

**4-9. Making Freehand Drawings on a Projected Image (ChalkBoard)**

The ChalkBoard feature allows you to write and draw messages on a projected image.

*NOTE: The ChalkBoard feature is available only when a USB mouse is used.*

From the menu, select [Tools] → [ChalkBoard] to display the ChalkBoard tool bar that contains the following icons.

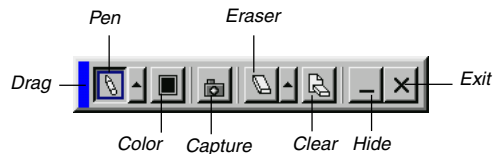

- Drag ..... Drags to move the tool bar by clicking on the blue part. (for USB mouse operation only)
- Pen ..... Left-click and drag to draw. Left-click ▲ or right-click the pen icon to display the pen palette containing four lines of different thickness from which you can select a line you prefer by left-clicking.
- Color ..... Selects a color. Left-click to display the color palette from which you can select a color you prefer by left-clicking.
- Capture .... Left-click to capture and save freehand drawings in the PC card.
- Eraser ..... Left-click and drag to erase part of a drawing. Left-click ▲ or right-click the eraser icon to display the eraser palette containing four eraser of different thickness from which you can select an eraser you prefer by left-clicking.
- Clear ..... Left-click to clear the drawing completely from the ChalkBoard screen.
- Hide ..... Hides the tool bar by left-clicking. Right-clicking anywhere on the screen displays the ChalkBoard tool bar again.
- Exit ..... Clears the complete drawing and exits the ChalkBoard.

*NOTE:*

- The menu is not available while you display the ChalkBoard screen.
- Switching slides clears a drawing completely.

## 4-10 USB Memory Device or USB Memory Card Reader Support

The projector is compatible with either a USB memory device or USB memory card reader which supports the viewer and security features.

- To use a USB memory device or USB memory card reader, connect the device to the USB port (type A).
- Select one of the Drive icons in the Viewer toolbar, Capture toolbar and PC Card File setting screen. Up to four drives can be accepted.
- To use a USB memory device as a Protect key for Security function, select one from the Drive icons in the Security setting screen.

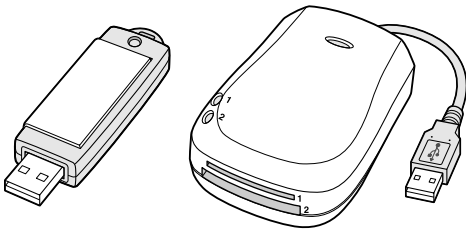

### NOTE:

- Some USB memory devices (brands) or USB memory card readers may not work.
- You cannot use a USB memory device and a USB memory card reader when connecting a USB mouse to the projector. Using a USB HUB that allows multiple USB memory devices or card readers is not supported either.
- Do not do the following while the USB memory device or USB memory card reader's access indicator is lit or flashing (while data is being accessed.) Doing so can damage your USB memory device or USB memory card in the reader. Back up your data in case it will need to be restored.
  - \* Pulling out the USB memory device or USB memory card reader from the USB port of the projector.
  - \* Pulling out the memory card from the USB memory card reader
  - \* Turning off the main power switch or unplugging the power cable.
- The drive for "USB 1-4" is displayed only when the USB memory device or USB memory card reader is connected to the projector. The drive for "USB 1-4" may be displayed differently from the one in the USB memory card reader.
- Some USB memory devices (brands) or USB memory cards cannot be used as Protect key for the projector's Security function.

# 5. Using the Viewer

**NOTE:**

- To use the Viewer, first you need to create presentation materials on your PC using the Dynamic Image Utility 2.0 contained on the supplied NEC Projector User Supportware CD-ROM. For installation, see the printed NEC Software Utility Installation Guide. For creating presentation materials, see the Slide show function on the on-line manual of the Dynamic Image Utility 2.0.
- Selecting Viewer sets the audio input for DVI input.

## 5-1. Making the Most out of the Viewer Function

### Features

You can view presentation data, capture, and play images on the projector. A PC card is used to view presentation data prepared on the computer and to capture and play images projected with the projector.

The Viewer feature allows you to view slides stored on a PC memory card (referred to as PC card in this manual) on the projector. Even if no computer is available, presentations can be conducted simply with the projector. This feature is convenient for holding presentations at meetings and in offices, as well as for playing images taken on digital cameras.

### Easy to use

- Presentations can be started immediately simply by inserting a PC card (not supplied)
- Easy slide switching
- Remote control operation
- Jumping to list of slides or any specific slide

### High quality images

- High resolution up to 1024 x 768 dots
- 24-bit full color playback
- Viewing of digital camera images

### Simple utility software (for computer)

- Dynamic Image Utility 2.0 operable on Windows 98/Me/XP/2000
  - Slides can be created by capturing the currently displayed image
  - Control screen for displaying lists of slides and editing
- \* Microsoft, Windows and PowerPoint are registered trademarks of Microsoft Corporation.

### Inserting and Removing a PC Card

**NOTE:** Do not try to force the PC card into the slot.

PC CARD

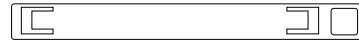

#### Inserting the PC Card

- Hold the PC card horizontally and insert it slowly into PC card slot with its top facing up.
- The eject button pops out once the PC card is fully inserted. Check that the PC card is fully inserted.

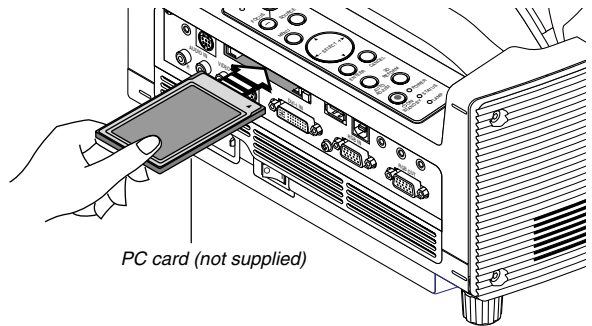

#### Removing the PC Card

Press the eject button. The PC card pops out a little. Grasp the edges of the PC card and pull it out.

**NOTE:** Do not eject the PC card while its data is being accessed.

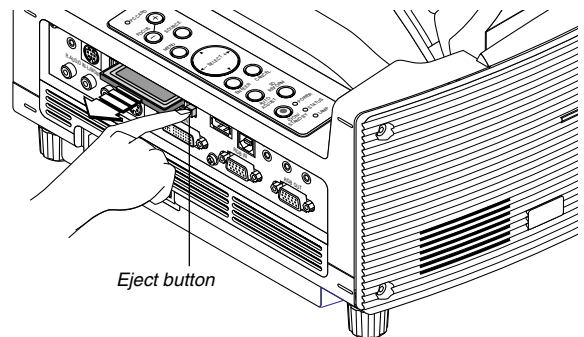

#### Direction for Inserting the PC Card

The PC card has a top and bottom and must be inserted into the PC card slot in a specific direction. It cannot be inserted backwards or upside-down. Attempting to force it into the slot in the wrong direction may break the internal pin and damage the card slot. Refer to the PC card's operating instructions for the proper direction of insertion.

#### PC Card Type

The PC Card slot accepts PCMCIA Type II only.

**CAUTION:** Do not use CompactFlash type cards except for flash memory cards. Using a CompactFlash card with the help of a PC card adapter could cause damage to the CompactFlash card.

## 5-2. Operating the Viewer Function from the Projector (playback)

This section describes the operation for showing slides of presentation documents created using the Viewer function with the projector. It is also possible to make slides directly from the images projected with the projector.

### Projecting slides (Viewer)

1. Insert a PC card into the PC card slot.  
Insert the PC card so that the end with the insertion direction arrow on the top goes in first.  
\* Press the eject button to eject the card.
2. Select the "Viewer" from the Source Select menu.
3. Project slides.

Checking "Show Folder List", means that selecting Viewer input displays a list of the folders in the PC card and if "Auto Play" is checked the projector automatically starts to play slides at the first slide of the folder you have selected.

A tool bar will appear when you press the MENU button on the remote control or the projector cabinet or clicking with the right button of a mouse.

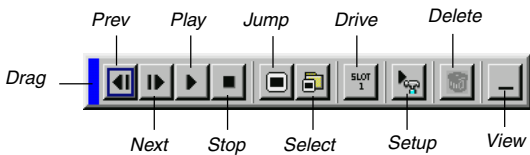

The tool bar includes the following buttons:

- Drag ..... Drags to move the tool bar. This is available for USB mouse operation only.
- Prev ..... Returns to the previous slide or folder. Or this lets you play slides back in reverse.
- Next ..... Advances to the next slide or folder. Or this lets you play slides back.
- Play ..... Plays back automatically or manually depending on the setting on Viewer Options of the menu. This allows you to move on to the next slide when "Manual Play" is selected.
- Stop ..... This allows you to stop Auto Play while you are playing back and to resume playing from the selected slide or folder when "Auto Play" is selected.
- Jump ..... Displays a list of slides while you are playing back.
- Select ..... Displays a list of folders while you are playing back.
- Drive ..... Switches between PC Card slot or USB memory.
- Setup ..... Displays the Viewer Options dialog box on Page 2 of the Setup dialog box.
- Delete ..... Deletes a captured slide(s) or all the captured slides in the Capture - specific folder.
- View ..... Hides the tool bar while you are playing back. Pressing the MENU button or clicking with the right button of a mouse shows it again.

*NOTE: If no memory card is inserted in the PC CARD slot, there is no signal, and a black, blue or logo background is displayed, depending on the setting.*

*Playback is stopped when SLIDE +/- button on the remote control or ◀▶ button on the cabinet is pressed in Auto Play mode.*

*Up to 12 indexes can be displayed on the list of folders. The folder in the right bottom is always a folder exclusively for captured images, but is only displayed when images have been captured.*

### When the tool bar is not displayed:

Press the FOLDER LIST button or the SLIDE LIST button on the remote control to display folders or slides from a PC card in the projector's PC Card slot.

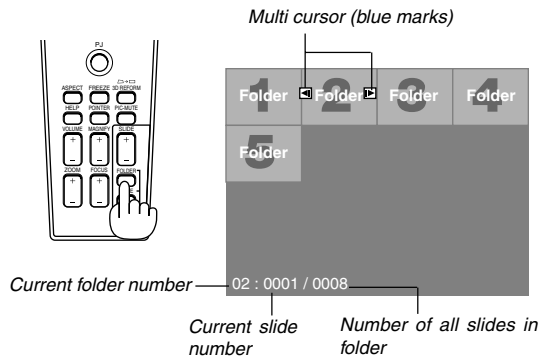

Use the SLIDE +/- button to advance to the next folder or return to the previous folder.

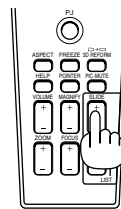

Use the SLIDE +/- button to advance to the next slide or return to the previous slide.

### Slide(Table) cursor (green marks)



*NOTE: You can also use the ◀ and ▶ button on the remote control to select folders or slides.*

*If you use the ◀ and ▶ button on the remote control for Viewer operation, press the PJ button to switch to the Projector mode and the PJ button lights red.*

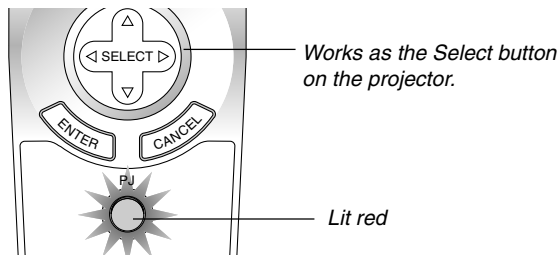

**Auto Play Mode**

If the "Auto Play" option is selected in "Viewer Options" of the menu, any given slide will start to play automatically. You can also specify Auto Play Interval between 5 and 300 seconds.

**Switching to Slides Directly from Other Input Modes**

With this function it is possible to switch directly to a slide when the picture of a VCR or computer is being projected. Example: When conducting presentations using a combination of slides and moving pictures from a VCR, etc., it is possible to switch from a Viewer slide to the video picture then back to the Viewer slide simply by using the Viewer button.

*NOTE: Even if you switch the current Viewer source to another source, the current slide is retained. When you return back to the Viewer, you will get the slide that has been retained.*

The PC card editing operation cannot be performed from the projector. Do so using the Dynamic Image Utility 2.0 software.

**Viewing Digital Images**

Digital images can be played with the Viewer if the following conditions are met:

- If the image can be stored on an MS-DOS format PC card
- If the image can be stored in a format supported by the Viewer. With the Viewer, images on the card are searched for in directories and images in JPEG or BMP format are recognized as slides. Searchable directories are directories within two steps from the root directory, and searchable images are images within the first 12 files in the directory. Only file and slide switching are possible.

*NOTE: The maximum number of images recognized as slides within one directory is 128.*

**Storing Images Displayed on the Projector on the PC card (Capture)**

The Capture features allows you to capture an image from a source that is currently being displayed. The image is saved as JPEG in the PC card. When you select Capture from the menu, you will get a tool bar. You can capture an image directly using the tool bar when the menu is not displayed.

*NOTE:*

- \* Unless a PC card is inserted into the PC Card slot of the projector, the Capture feature is not available.
- \* The "Card Error" display means that the free space of the PC card is insufficient for saving images. Make more space available on the card by erasing unwanted images with your PC. The number of images that can be captured depends on the size of the PC card.
- \* Be sure not to turn off the power or remove the PC card while capturing an image. Doing so could cause a loss of the data in the PC card or damage to the card itself.

**Preparations:**

Insert the PC card into the card slot. Insert the PC card so that the end with the insertion direction arrow on the top goes in first.

- \* Press the eject button to eject the card.

1. Project the image you wish to store on the projector.
2. Select the "Capture" from the Tools menu.

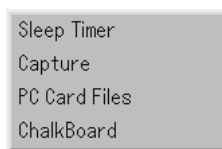

3. A tool bar will appear.

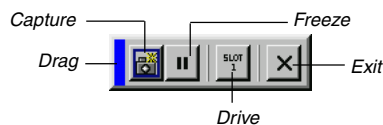

The tool bar includes the following buttons:

- Drag ..... Drags to move the tool bar by clicking on the blue part (for USB mouse operation only).
- Capture ..... Captures an image and save it as a JPEG file on a PC card.
- Freeze ..... Freezes and unfreezes images.
- Drive ..... Switches between PC Card slot or USB memory.
- Exit ..... Exits the Capture function. Another option to exit the Capture function is to press MENU or CANCEL button on the remote control or projector cabinet.



**NOTE:**

You can compress a captured file (JPEG) using the Capture Options in the Setup dialog. See page 6-15.

Captured images with higher resolution than the projector's native resolution cannot be displayed correctly.

- File size of the captured image varies depending on the resolution of an input signal.
- An hourglass indicating that an image is being captured appears on the projector's display. Do not eject the PC card or turn off the projector's power while this icon is displayed. Doing so will damage the PC card data. If the PC card data is damaged, use a computer to repair the data.
- Up to 12 indexes can be displayed on the list of folders. The folder in the right bottom is always a folder exclusively for captured images, but is only displayed when images have been captured.

*NOTE: This option is not available for selection unless a PC card is inserted properly.*

Selecting "Execute" displays the file you selected. When you select a JPEG or BMP file and press the ENTER button on the remote or the cabinet, or "Execute" on the above, you will get a toolbar. This toolbar is used to return to the PC Card Files screen.

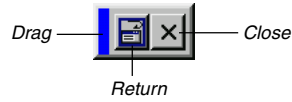

Drag ..... Drags to move the tool bar. (for USB mouse operation only)

Return ..... Returns to the PC Card Files screen.

Close ..... Close the toolbar.

**Deleting Captured Images**

Using the Delete button on the tool bar for Viewer can delete captured images.

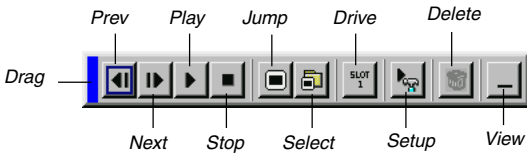

To delete captured images:

1. Select Viewer and display a folder list of captured images.
2. Use button to select the Capture folder [Cap] in the right bottom of the screen.
3. Press the MENU button to display the tool bar.
4. Use the or button to select the Delete icon and press the ENTER button or click with a mouse button.

**Using the PC Card Files Function (PC Card Files)**

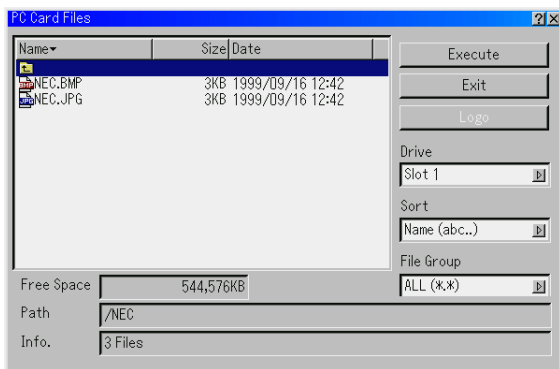

The PC Card Files function allows you to display a list of all the files stored in the PC card so that you can select a file you want to display. You can also sort files by file name or date, or display the file. Although a list of all the files in the PC card is displayed, you can view files in idx, text, HTML, JPEG and BMP format only. Selecting BMP and JPEG files automatically switches to the Viewer source. See also page 6-6.

# 6. Using On-Screen Menu

## 6-1. Basic Menu Operation

### Using the Menus

*NOTE: The on-screen menu may not be displayed correctly while interlaced motion video image is projected.*

1. Press the MENU button on the remote control or projector cabinet to display the Basic, Advanced or Custom Menu.

*NOTE: When using a USB mouse, click the mouse button to display the menu. For other operations, do the same way as you use your PC mouse.*

2. Press the SELECT ▲▼ buttons on the remote control or the projector cabinet to highlight the menu for the item you want to adjust or set.
3. Press the SELECT ► button or the ENTER button on the remote control or the projector cabinet to select a submenu or item.
4. Adjust the level or turn the selected item on or off by using SELECT ◀ or ▶ buttons on the remote control or the projector cabinet.  
The on-screen slide bar will show you the amount of increase or decrease.
5. Changes are stored until you adjust it again.

ENTER ..... Stores the setting or adjustments.  
CANCEL ..... Return to the previous screen without storing settings or adjustments.

*NOTE: You can close the main and sub menus simultaneously by pressing the PJ button on the remote control to cancel the Projector mode.*

6. Repeat steps 2-5 to adjust an additional item, or press the CANCEL button on the projector cabinet or the remote control to quit the menu display.

### Customizing the Menu

The Custom menu can be customized to meet your requirements. Selecting a menu item from the "Custom Menu Edit" list, allows you to custom tailor the menu items to your needs.

1. Select "Custom Menu Edit" to display the "Custom Menu Edit" screen.
2. Use the SELECT ▲ or ▼ buttons to highlight your selection and press the ENTER button to place a check mark next to an option.  
This action enables that feature. Press the ENTER button again to clear the check box.  
If you select an item with a solid triangle ► and press the ENTER button on the remote control or the projector cabinet, you can enable all the items within that submenu. Also you can turn on an item within the submenu without placing a check mark on the main menu item.

*NOTE: Up to 12 main menu items (within Custom Menu Edit, not including submenu items) can be selected.*

3. In order for the changes to take effect, use the SELECT ◀ or ► button on the remote control or the projector cabinet to highlight "OK", then press the ENTER button. To cancel the changes, use the SELECT ▲ or ▼ buttons to highlight "Cancel" and press the ENTER button.  
To return to the factory default, select "Reset" then press the ENTER button.

### The default Custom Menu items are:

Source Select (RGB, DVI [DIGITAL], DVI [ANALOG], Video, S-Video, Viewer and LAN), Picture, Volume, Image Options (Aspect Ratio), Picture Management, Projector Options (3D Reform, Menu, Setup, Screen and LAN Mode), Tools (Sleep Timer, Capture, PC Card Files and ChalkBoard) and Help (Contents and Information).

*NOTE: Once you have selected OK on the Custom Menu Edit screen, you cannot cancel the changes on the Menu screen. However, you can reedit the menu items over again as described in the steps above.*

*NOTE: If the "Advanced Menu" item has been selected on the Menu mode, you get the "Confirmation Change Menu" upon completion of "Custom Menu" editing. In this case, selecting "Yes" then "ENTER" will close all the menus and apply the changes from the Advanced menu to the Custom Menu. If you select "No" then "ENTER" functions, then all menu items will return to the Advanced menu, but your changes will still be available within the "Custom Menu" selection. To display the previously tailored Custom Menu, select "Custom Menu" from the "Menu Mode".*

An item "To Advanced Menu" will be added to the bottom of the Custom Menu.

Selecting this item and pressing the ENTER button will display the "Advanced Menu" features.

## 6-2. Menu Tree

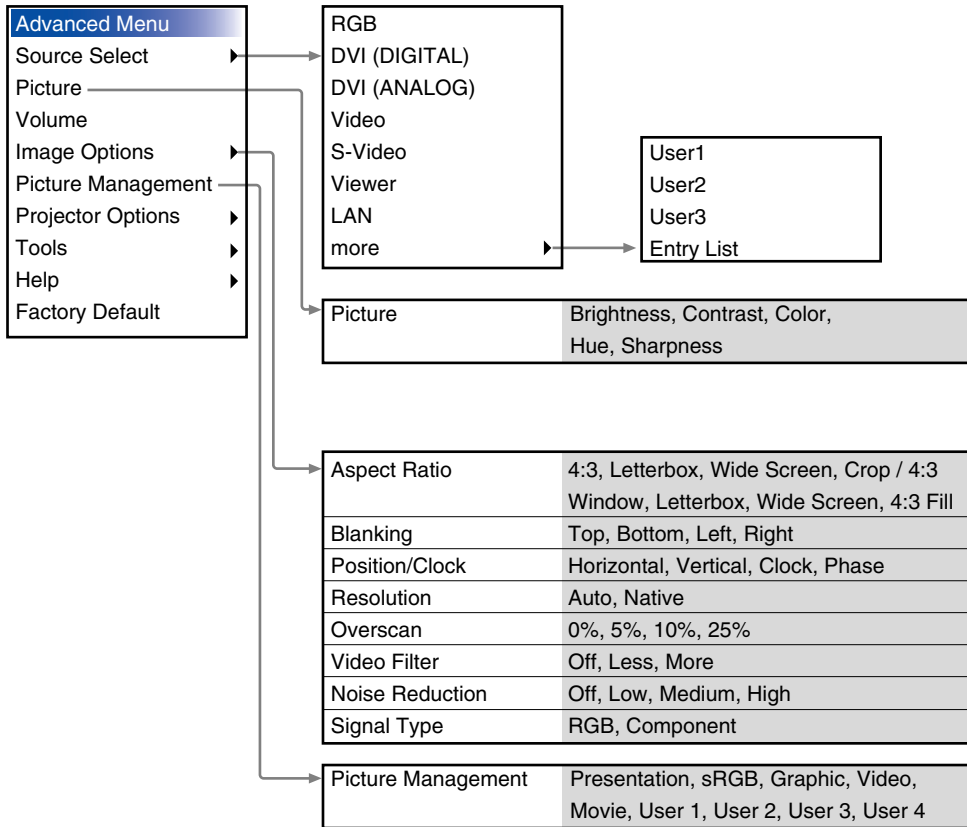

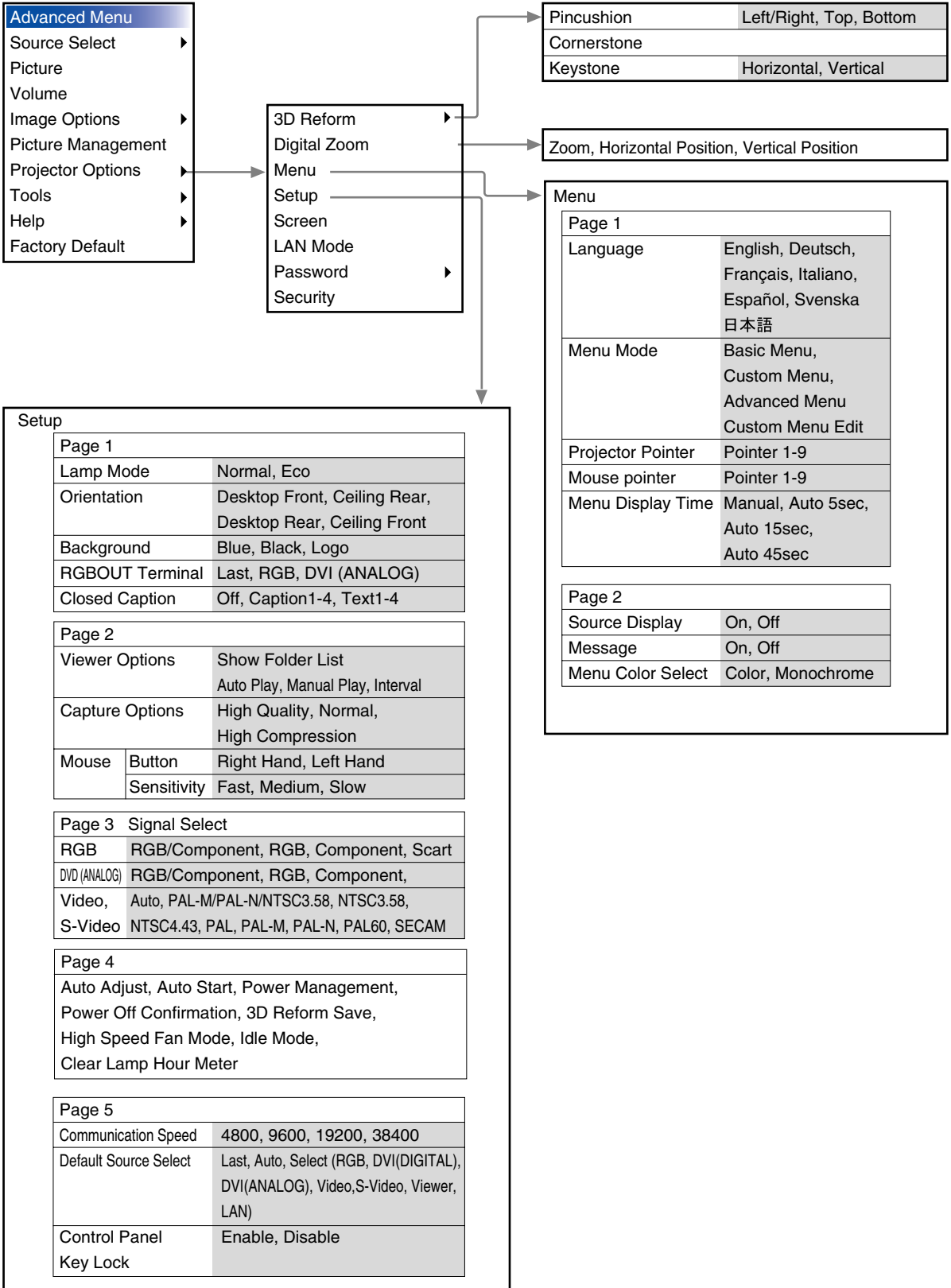

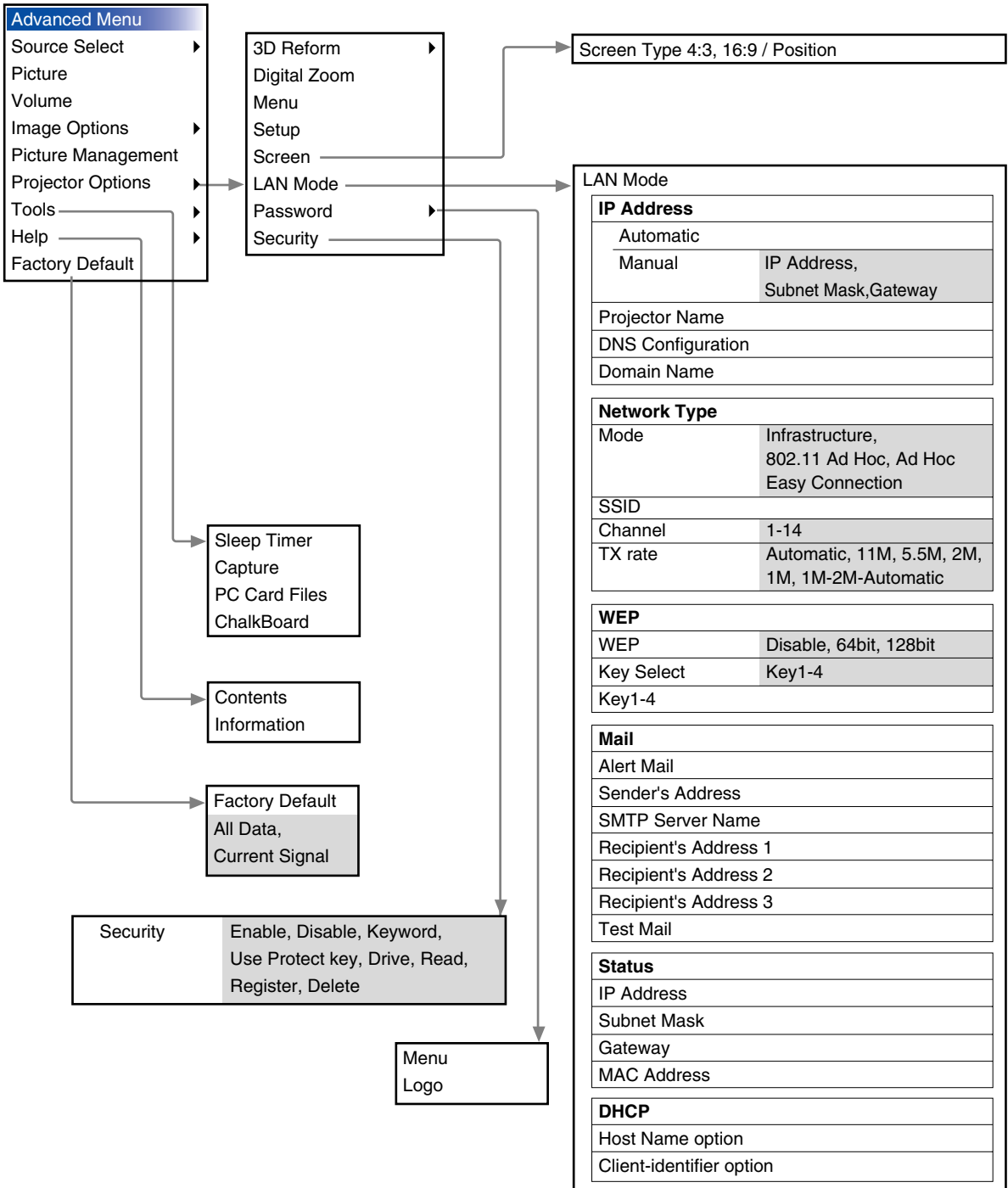

### 6-3. Menu Elements

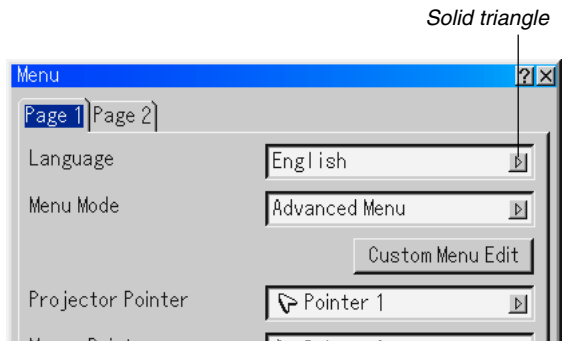
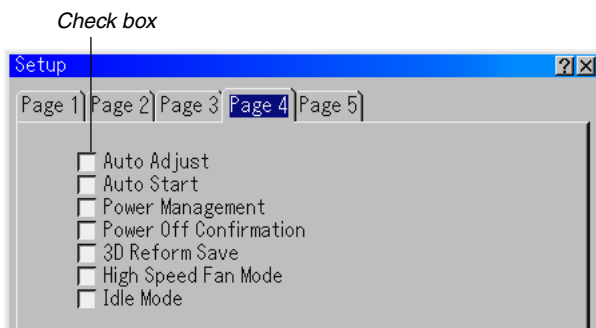
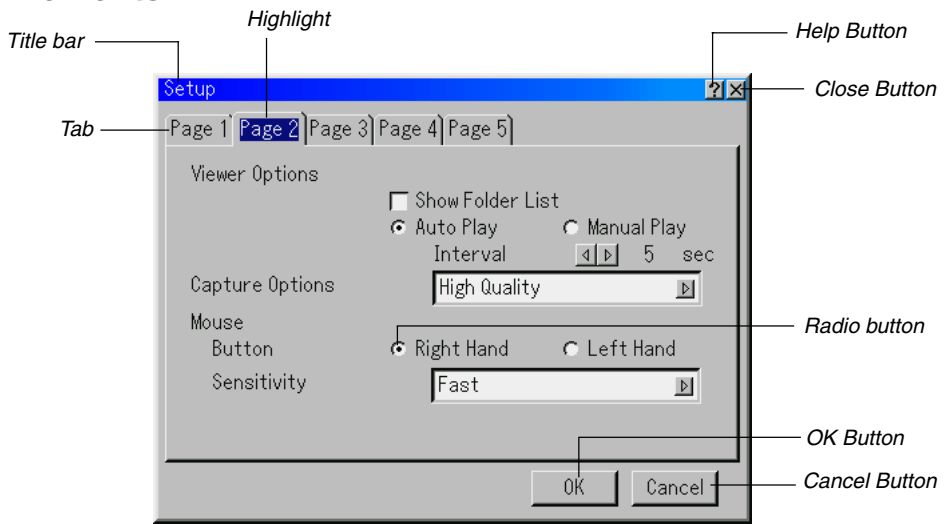

Menu windows or dialog boxes typically have the following elements:

- Title bar ..... Indicates the menu title.
- Highlight ..... Indicates the selected menu or item.
- Solid triangle ... Indicates further choices are available. A high-lighted triangle indicates the item is active.
- Tab ..... Indicates a group of features in a dialog box. Selecting on any tab brings its page to the front.
- Radio button .... Use this round button to select an option in a dialog box.
- Check box ..... Place a checkmark in the square box to turn the option On.
- Slide bar ..... Indicates settings or the direction of adjustment.

- OK button ..... Press to confirm your setting. You will return to the previous menu.
- Cancel button .. Press to cancel your setting. You will return to the previous menu.
- Close button .... Click to close the window with saving changes. (USB mouse only)
- Help button ..... Indicates that help about that feature is available (USB mouse only). Press the Help button on the remote control to display help.
- Toolbar ..... Contains several icons for specific tasks. It is also referred to as "launcher".

### 6-4. Entering Alphanumeric Characters by Using the Menu

Alphabet or numeric characters are used for your IP address or projector name. To enter IP Address or projector name, use the software keyboard.

For using the software keyboard, see page 10-5.

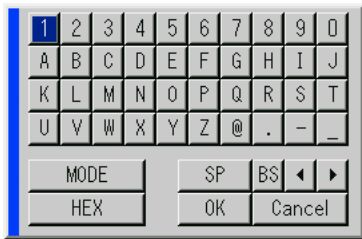

### 6-5. Menu Descriptions & Functions

#### Source Select

Selecting a Source  
Enables you to select a video source such as a VCR, DVD player, laser disc player, computer or document camera depending on what is connected to your inputs. Press the SELECT ▲▼ button on the projector cabinet or on your remote control to highlight the menu for the source you want to project.

#### RGB

Selects the computer connected to your RGB or component signal.

*NOTE: An optional component cable (Component V or ADP-CV1 cable) is needed for a component signal.*

#### Video

Selects what is connected to your Video input-VCR, laser disc player, DVD player or document camera.

#### S-Video

Selects what is connected to your S-Video input-VCR, DVD player, or laser disc player.

*NOTE: A frame may freeze for a brief period of time when a video is played back in fast-forward or fast-rewind with a Video or S-Video source.*

#### DVI (DIGITAL/ANALOG)

Selects the computer connected to the DVI input connector.

#### Viewer

This feature enables you to make presentations using a PC card that contains captured images and slides created with the exclusive Dynamic Image Utility 2.0 contained in the CD-ROM. See the supplied Software Utility Installation Guide for installing the Dynamic Image Utility 2.0. The starting screen for the Viewer varies depending on the settings of the Setup's Page 2. See Setup on page 6-15.

*NOTE: Even if you switch the current Viewer source to another source, the current slide is retained. When you return back to the Viewer, you will get the slide that has been retained. A launcher will appear when you press the MENU button.*

A press of the MENU button displays the toolbar; a press of the MENU button again displays the Menu and hereafter each press of the MENU button switches displaying between the Menu and the toolbar.

The launcher is a tool bar including the following buttons:

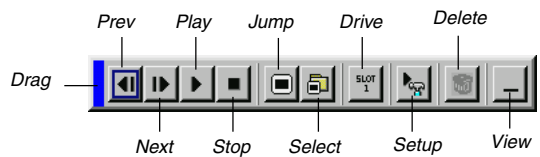

- Drag ..... Drags to move the tool bar. (for USB mouse operation only)
- Prev ..... Returns to the previous slide or folder.
- Next ..... Advances to the next slide or folder.
- Play ..... Plays back automatically or manually depending on the setting on Viewer Options of the menu. This allows you to move on to the next slide when "Manual Play" is selected.
- Stop ..... Stops Auto Play while you are playing back and to resume playing from the selected slide or folder when "Auto Play" is selected.
- Jump ..... Displays a list of slides while you are playing back.
- Select ..... Displays a list of folders while you are playing back.
- Drive ..... Switches between PC Card slot or USB memory.
- Setup ..... Displays the Viewer Options dialog box on Page 2 of the Setup dialog box.
- Delete ..... Deletes a captured slide(s) or all the captured slides in the selected folder.
- View ..... Hides the tool bar while you are playing back. Clicking with the right button of a mouse shows it again.  
Provides access to controls for your image. Use the SELECT button on the projector cabinet or the remote control to highlight the menu for the item you want to adjust.

#### LAN

Selects a signal from a LAN card plugged into the projector's card slot.

**Entry List**

No.	Name	Source	Input	Select	▲▼	✕
001	123456789012345678	RGB	RGB	✓		
002	SVGA	RGB	DVI(ANALOG)	✓		
003	N TSC3.58	Video	Video	User3 ✓		
004	S-VIDEO	S-Video	S-Video	✓		
005	12345678901234567	RGB	RGB	✓		
006	COMP0	Component	RGB	✓		
007	Digital	---	DVI(DIGITAL)	✓		
008	Viewer	---	Viewer	✓		
009	Scart	Scart	RGB	✓		
010	COMP0(Y,Cb,Cr)	Component	RGB	✓		
011				✓		

Displays the list of the entry signals. Use the SELECT ▲▼ buttons on your remote control or the projector cabinet to select the signal and press the ENTER button on the remote control or the projector cabinet to display the Entry Edit Command screen.

**Using the Entry List**

Making any adjustments to the current picture will automatically register its adjustments to the Entry List. The registered signal can be loaded any time from the Entry List.

*NOTE: Up to 100 presets can be registered.*

**Entry Edit Command**

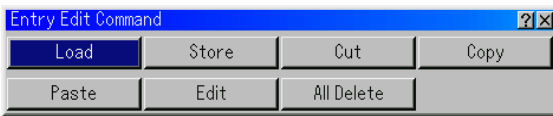

You can edit signals on the Entry List.

- Load ..... Enables you to select a signal from the list.
- Store ..... Enables you to store the currently projected signal.
- Cut ..... Enables you to remove a selected signal from the list and place it on the "clipboard" in the projector.
- Copy ..... Enables you to copy a selected signal from the list and place it on the "clipboard" in the projector.
- Paste ..... Enables you to paste the signal placed on the "clipboard" to any other line of the list. To do this, select "Paste" and then select the line number you want to paste to. Last press ENTER.
- Edit ..... Enables you to change source names or add source names to "More" in the Source Select.
  - Source Name .. Enter a signal name. Up to 18 alphanumeric characters can be used.
  - Input Terminal .. Change the input terminal. RGB is available for RGB and DVI (ANALOG/DIGITAL) signal; Video and S-Video are available for composite signal.
  - Source List ..... Set signal selection method.
  - Lock ..... Set so that the selected signal cannot be deleted when "All Delete" is executed.
  - Skip ..... Set so that the selected signal will be skipped during auto search.

When complete, select OK and press ENTER. To exit without storing setting, select Cancel. Select "Source Name" and press ENTER to display the Source Name Edit window. You can change source name on this window. Press [▼] to display the software keyboard, which you can enter alphanumeric characters. See page 10-5 for the key function of the software keyboard.

All Delete ..... This feature enables you to delete all the registered signals in the Entry List.

The following buttons are not available for the currently projecting signals:

- 1) The Cut and Paste buttons on the Entry Edit Command screen
- 2) The Input Terminal button on the Entry Edit screen

**Picture (not available for Viewer and LAN)**

Adjusting Brightness, Contrast, Color, Hue, and Sharpness

- Brightness ..... Adjusts the brightness level or the back raster intensity.
- Contrast ..... Adjusts the intensity of the image according to the incoming signal.
- Color ..... Increases or decreases the color saturation level (not valid for RGB).
- Hue ..... Varies the color level from +/- green to +/-blue. The red level is used as reference. This adjustment is only valid for Video and Component inputs (not valid for RGB).
- Sharpness ..... Controls the detail of the image for Video (Not valid for RGB).

**Volume**

Adjusts the sound level of the projector speaker and AUDIO OUT (mini jack).



**Image Options**

**Selecting Aspect Ratio (not available for Viewer and LAN)**

Aspect Ratio allows you to select the best Aspect mode to display your source image.

When screen size 4:3 is selected for the source, the following selections will display:

- 4:3 ..... Standard 4:3 aspect
- Letter Box .... Reduced to display the true aspect with black borders on top and bottom
- Wide Screen .. Left & Right stretched with black borders on top and bottom
- Crop ..... Left & Right stretched.  
Left & Right sides cut. Available for 4:3 only.

When screen size 16:9 is selected for the source, the following selections will display:

- 4:3 Window .. Reduced to display the true aspect with black borders on right and left
- Letter Box .... Standard 16:9 aspect
- Wide Screen Left and right stretched to display the true aspect
- 4:3 Fill ..... Stretched to display in 16:9 aspect ratio









*NOTE: You can adjust image positions vertically for source with black borders. See page 6-18 "Selecting Aspect Ratio and Position for Screen" for setting image positions.*

**Copyright**

*Please note that using this projector for the purpose of commercial gain or the attraction of public attention in a venue such as a coffee shop or hotel and employing compression or expansion of the screen image with a "Aspect Ratio" or "Screen" setting may raise concern about the infringement of copyrights which are protected by copyright law.*

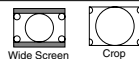
*NOTE: During 3D Reform adjustment, "Aspect Ratio" may not be available.*

*Should this happen, first reset the 3D Reform data and then do setting again. Second repeat the 3D Reform adjustment. Changing the aspect ratio can limit 3D Reform in its adjustable range.*

Input Signal Screen Type	 4:3	 Letterbox	 Squeeze
4:3 Screen	 4:3	 Letterbox	 Wide Screen   Crop
16:9 Screen	 4:3 Window   4:3 Fill	 Letterbox	 Wide Screen

**Masking Unwanted Area (Blanking)**

This feature allows you to mask any unwanted area of the screen image.

Adjust the Top, Bottom, Left or Right blanking with the SELECT ◀ or ▶ button.

**Adjusting Position and Clock**

This allows you to manually adjust the image horizontally and vertically, and adjust Clock and Phase.

Horizontal/Vertical Position:

Adjusts the image location horizontally and vertically using the SELECT ◀ and ▶ buttons. This adjustment is made automatically when the Auto Adjust is turned on. See "Auto Adjust" on page 6-16 for turning on or off the Auto Adjust feature.

Clock ..... Use this item to fine tune the computer image or to remove any vertical banding that might appear. This function adjusts the clock frequencies that eliminate the horizontal banding in the image.

Press the SELECT ◀ and ▶ buttons until the banding disappears. This adjustment may be necessary when you connect your computer for the first time. This adjustment is made automatically when the Auto Adjust is turned on.

Phase ..... Use this item to adjust the clock phase or to reduce video noise, dot interference or cross talk. (This is evident when part of your image appears to be shimmering.) Use the SELECT ◀ and ▶ buttons to adjust the image. Use "Phase" only after the "Clock" is complete. This adjustment is made automatically when the Auto Adjust is turned on.

**Selecting Resolution**

This allows you to activate or deactivate the Advanced AccuBlend feature.

Auto ..... Turns on the Advanced AccuBlend feature. The projector automatically reduces or enlarges the current image to fit the full screen.

Native ..... Turns off the Advanced AccuBlend feature. The projector displays the current image in its true resolution.

See "Auto Adjust" on page 6-16 for turning on or off the Auto Adjust feature.

**NOTE:**

\* When "Resolution" is set to "Native", "3D Reform", "Aspect Ratio", "Screen" and "Overscan" are not available.

\* While you are displaying an image with higher resolution than the projector's native resolution, "Resolution" is not available.

**Selecting Overscan Percentage**

Select overscan percentage (0%, 5%, 10% and 25%) for signal.

*NOTE: When "Resolution" is set to "Native", this feature is not available, and the stored settings and adjustments are invalid.*

*NOTE: When "4:3 Fill" or "Crop" is selected in "Aspect Ratio", this feature is not available.*

**Selecting Video Filter Level (not available for Video, Viewer and LAN)**

This function reduces video noise.

- Off ..... The filter is removed.
- Less ..... The low-pass filter is applied partially.
- More ..... The low-pass filter is applied fully.

**Selecting Noise Reduction Level (not available for RGB, Viewer and LAN)**

Select one of the three levels for reducing video noise: Low, Medium or High.

*NOTE: The lower the Noise Reduction level, the better the image quality by way of higher video bandwidth.*

**Signal Type**

Select either the RGB signal type or the Component signal type.

- RGB ..... RGB signal
- Component .. Component signals such as Y/Cb/Cr, Y/Pb/Pr

*NOTE: This feature is available on RGB input only. If you do not get a better picture even when you set "Signal Select" to "Component" in Setup, set this to "Component".*

**Picture Management**

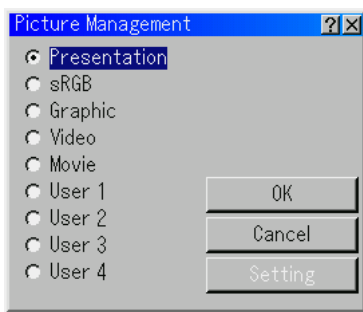

This option allows you to adjust neutral tint for yellow, cyan or magenta.

There are 5 factory presets optimized for various types of images, or you can set 4 user adjustable settings.

- Presentation Recommended for making a presentation using a PowerPoint file
- sRGB ..... Standard color values
- Graphic ..... Recommended for graphics
- Video ..... Recommended for regular picture such as TV program
- Movie ..... Recommended for movie
- User 1-4 ..... User adjustable

*NOTE: When "sRGB", "Graphic", "Video" or "Movie" is selected, the brightness decreases slightly when compared to "Presentation". This is not a malfunction.*

**User Adjust (when using User 1 to 4)**

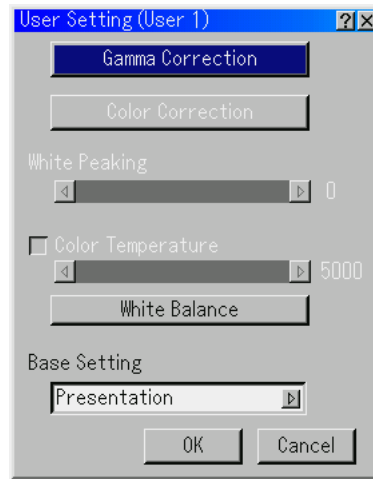

When selecting one of four user adjustable presets (User 1 through 4), the submenu will be displayed. You can customize each gamma or color. To do so, first select [Setting] and press the ENTER button, and then proceed the following steps.

**Selecting Gamma Correction Mode**

Use the ◀ or ▶ buttons to choose one mode from three options. Each mode is recommended for :

- Dynamic ..... For true color reproduction of natural tones
- Natural ..... Normal settings
- Black Detail . For dark portions of a picture

**Selecting Color Correction**

Adjusts red, green, blue, yellow, magenta, cyan and color gain each independently to correct the tint on whole screen.

**Selecting White Peaking**

Adjust the brightness of the white areas by using the slide bar. As the picture becomes dim, it looks more natural.

**Adjusting Color Temperature and White Balance**

This feature adjusts the color temperature using the slide bar.

Checking "Color Temperature" enables the color temperature slide bar and disables the "White Balance" button.

Clear "Color Temperature" and press the White Balance button to access the Contrast/Brightness adjustment for each R, G, and B.

*NOTE: "Color Temperature" and "White Balance" are a trade-off. The White Balance is not available for Viewer and LAN.*

*NOTE: When "Presentation" is selected, the available items are "Gamma" and "White Balance" only.*

**Selecting Base Setting**

This feature allows you to use color correction or gamma values as reference data to optimize for various types of images. You can select one of the following five settings.

- Presentation      • sRGB      • Graphic
- Video              • Movie

**Projector Options**

**Using 3D Reform**

This feature corrects trapezoidal distortion so that the projected image is rectangular.

Two options are available for correcting procedures.

You can save adjustment settings by using the 3D Reform Save option on Setup (See page 6-17).

**1. Correcting Pincushion Distortion**

If the horizontal and vertical sides bend outwards, use Pincushion to correct the distortion.



[Left/Right]

Correct the left and right side on a projected image to level as shown in the drawing.

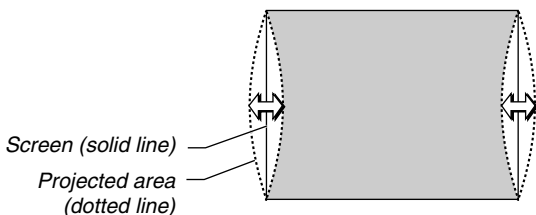

[Top]

Correct the top side on a projected image to level as shown in the drawing.

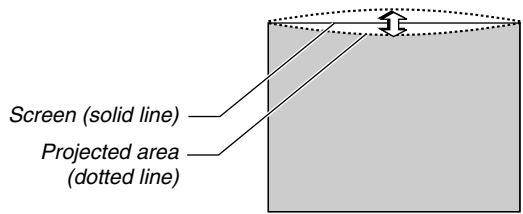

[Bottom]

Correct the bottom side on a projected image to level as shown in the drawing.

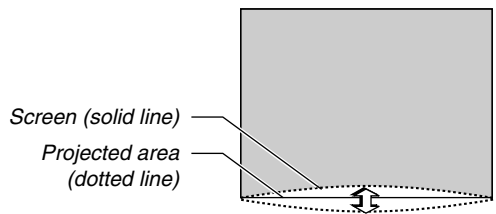

**NOTE:**

- In the [Pincushion] screen, when the [Top] adjustment value is "0", adjustment of [Bottom] will not be possible\* . Also note that when the adjustment value of the [Top] is a small value (on the order of +5), there will be almost no change of the image even when the [Bottom] is adjusted\* .
  - In [Pincushion] screen, when the [Bottom] adjustment value is less than "0", a small portion can be lost at the bottom area of the image. To display the lost portion, use the [Digital Zoom] function to reduce the size of the projected image.\*
  - When [Cornerstone] or [Keystone] has already been adjusted, selection of [Pincushion] will not be possible. To display [Pincushion], return the adjustment values of [Cornerstone] or [Keystone] to the factory shipping conditions.
- \* Each note for [Top] and [Bottom] is reversed when the [Ceiling Rear] or [Ceiling Front] is selected in [Orientation]

**Reference**

- Pincushion or barrel distortion in this projector
- The amount of pincushion and barrel distortion in this projector is 2% or less (TV distortion) in each of the horizontal and vertical directions (for screen sizes of 40 inches to 100 inches). As an example, the amount of distortion with a screen size of 60 inches (121.9 cm/48.0" W x 91.4 cm/36.0" H) is within approximately 12 mm/0.47" in the horizontal direction and within approximately 9 mm/0.35" in the vertical direction. When this projector is used with a 60-inch screen size, the amount of pincushion and barrel distortion become a minimum.

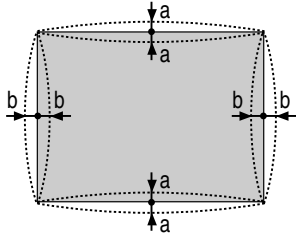

a: 1% or less of the screen height  
(2% or less as TV distortion)

b: 1% or less of the screen width  
(2% or less as TV distortion)

When the amount of pincushion or barrel distortion exceed 2% (TV distortion), please check whether the projector and screen setup conditions are suitable.

## 2. Correcting Cornerstone Distortion

Use the 3D Reform feature to correct distortion to make the top or bottom and the left or right side of the screen longer or shorter so that the projected image is rectangular. In the following description, 3D Reform (Cornerstone) correction can be done with the USB mouse or remote control, cabinet buttons.

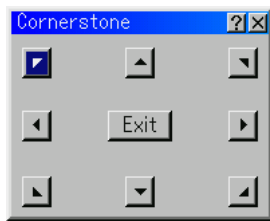

### When using the USB connected to the projector

Preparation: Connect the USB mouse to the projector. See page 4-3 "Using a USB Mouse".

1. Project an image so that the screen is smaller than the area of the raster.
2. Pick up any one of the corners and align the corner of the screen with the one of the image. (The drawing shows the upper right corner.)

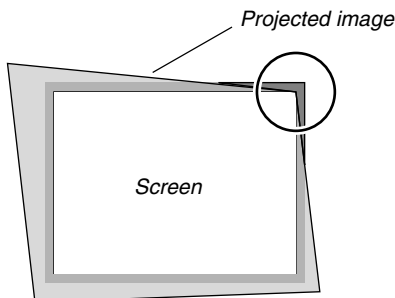

3. Press the 3D REFORM button on the remote control. The Cornerstone adjustment screen is displayed. The Cornerstone adjustment screen will disappear when you move the USB mouse cursor.

4. Point to one of the remaining 3 corners and left-click on it.

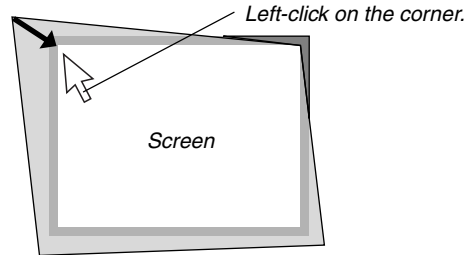

5. Do the above step 4 for the other two corners so that the projected area becomes smaller than the screen.

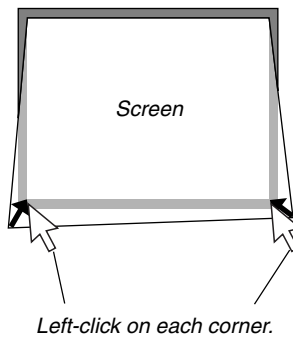

6. To complete the procedure, right-click anywhere on the screen. The confirmation screen is displayed.

7. Left-click on "OK". This completes the Cornerstone adjustment.

\* To return the Cornerstone adjustment to the default settings, left-click on "Reset".

You can save your Cornerstone changes. The changes are saved when you turn off the projector. To do so, select [Projector Options] → [Setup] → [Page 4]. Select the 3D Reform Save check box. This is not selected at the time of shipment.

\* There are limitations of shapes which can be corrected using the Cornerstone adjustment.

When adjusting the Cornerstone beyond these limits, you will get the message "Out of adjustment range!" and no correction can be done. Should this happen, do the Cornerstone adjustment again within the allowable range.

\* Due to limitations of accuracy within internal processes, there may be some discrepancy of positions between the mouse cursor and corrected shape or one corner and the other 3 corners.

**When using the remote control or cabinet buttons:**

1. Project an image so that the screen is smaller than the area of the raster.
2. Pick up any one of the corners and align the corner of the screen with the one of the image.  
(The drawing shows the upper right corner.)

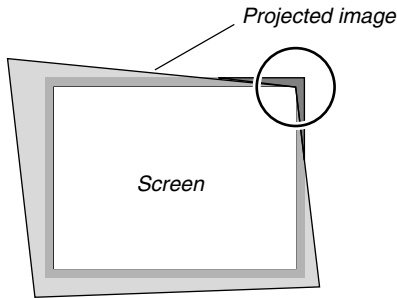

3. Press the 3D REFORM button on the remote control. The CORNERSTONE adjustment screen is displayed.



*NOTE: Each time the 3D REFORM button is pressed, the option will change as follows: "Pincushion" → "Cornerstone" → "Keystone" → ....*

4. Use the SELECT ▲▼◀▶ button to select one icon which points in the direction you wish to move the projected image frame.

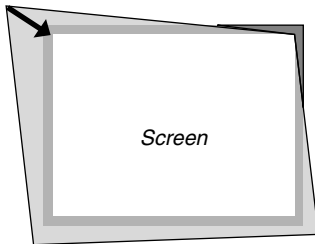

5. Press the ENTER button.
6. Use the SELECT ▲▼◀▶ button to move the projected image frame as shown on the example.
7. Press the ENTER button.

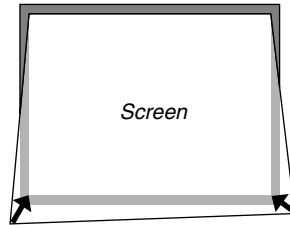

8. Use the SELECT ▲▼◀▶ button to select another icon which points in the direction.
9. Repeat the above steps 5 to 7 to adjust the image.

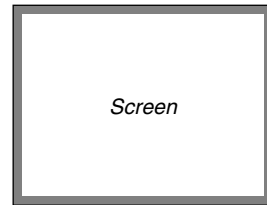

10. After having adjusted the image, select "Exit".

The confirmation screen is displayed.

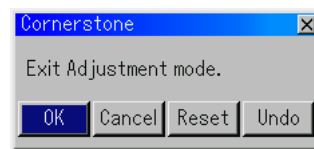

11. Press the SELECT ◀ or ▶ button to highlight the [OK] and press the ENTER button.

This completes the keystone correction. Selecting "Cancel" will return to the adjustment screen without saving changes (Step 3). Selecting "Reset" will return to the factory default. Selecting "Undo" will exit without saving changes.

*NOTE: To return the 3D Reform correction setting values to the factory default, press and hold the 3D REFORM button for a minimum of 2 seconds.*

*NOTE: During 3D Reform adjustment, "Aspect Ratio" and "Screen" may not be available. Should this happen, first reset the 3D Reform data and then do each setting. Second repeat the 3D Reform adjustment. Changing Aspect Ratio and/or Screen setting can limit 3D Reform in its adjustable range.*

The adjustable ranges for 3D Reform are as follows:

Horizontal ..... Max  $\pm 5^\circ$  approx.  
Vertical ..... Max  $-5^\circ$  to  $0^\circ$  approx.

- \* The following are conditions at the above maximum angle when all of the following are met
- Resolution is XGA  
Higher resolution than XGA limits 3D Reform in its adjustable range.
- Menu items should be set as follows:  
Aspect Ratio ..... 4:3  
Screen Type ..... 4:3
- Horizontal and Vertical are adjusted separately.  
A combination of both adjustments limits 3D Reform in its adjustable range.
- When "4:3 Fill" is selected in Aspect Ratio, "Cornerstone" and "Horizontal Keystone" and "Pincushion" are not available.

### 3. Correcting Keystone Distortion

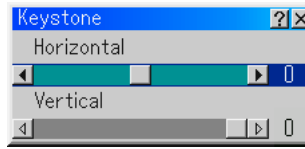

1. Press the SELECT ◀ button to adjust the horizontal keystone.
2. Press the SELECT ▲▼ button to select "Vertical".
3. Press the SELECT ▶ button to adjust the vertical keystone.
4. After completing, press the ENTER button. This will return to the menu screen.

- \* When "Resolution" is set to "Native", "Cornerstone", "Keystone" and "Pincushion" are not available.
- \* When any adjustment is made to the Digital Zoom or Pincushion option, the Cornerstone and Keystone options are not available.

### Digital Zoom

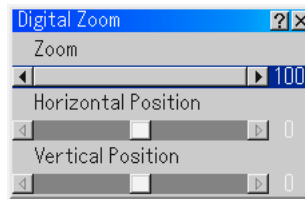

See page 3-3 for using Digital Zoom.

**Menu**

Allows you to set preferences for the on-screen menu. Press "OK" to save your changes for all the features of Page 1 and Page 2.

[Page1]

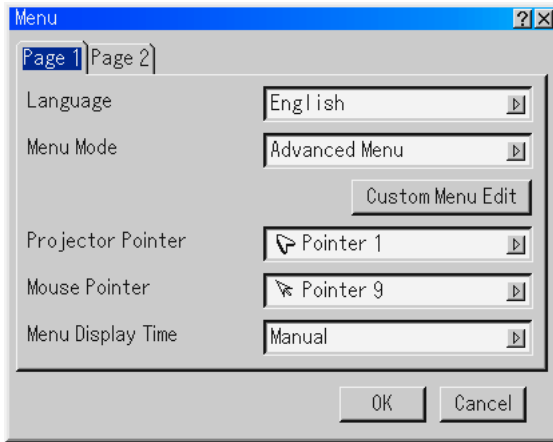

**Selecting Menu Language [Language]:**

You can choose one of seven languages for on-screen instructions. The options are: English, German, French, Italian, Spanish, Swedish and Japanese.

**Selecting Menu Mode [Menu Mode]:**

This feature allows you to select 3 menu modes: Advanced Menu, Custom Menu and Basic Menu.

**Advanced Menu** ..... This is the menu that contains all the available menus and commands.

**Basic Menu** ..... This is the basic menu that contains minimum essentials of menus and commands.

**Custom Menu** ..... This is the menu that you can customize using the Custom Menu Edit to fit your needs.

**Customizing the Menu:**

See page 6-1 for instructions about how to customize the Menu.

**Selecting a Projector Pointer Icon [Projector Pointer]:**

This enables you to select from nine different Pointer icons for the "Pointer" button on your remote control.

After moving your Pointer icon to the area you want on the screen, press the MAGNIFY button on the remote control to enlarge the selected area on the screen. See page 4-3 for more details.

*NOTE: There may be cases where the Pointer function is not available (ex. a non-interlace signal at 15kHz such as video game.)*

**Selecting a Mouse Pointer Icon [Mouse Pointer]**

This option enables you to select one of nine different mouse pointers when using a USB mouse.

**Selecting Menu Display Time:**

This option allows you to select how long the projector waits after the last touch of a button to turn off the menu.

The preset choices are "Manual", "Auto 5 sec", "Auto 15 sec", and "Auto 45 sec". The "Auto 45 sec" is the factory preset.

**Manual** ..... The menu can be turned off manually.

**Auto 5 sec** ... The menu will automatically be turned off in 5 seconds if no buttons are pressed within 5 seconds.

**Auto 15 sec** . The menu will automatically be turned off in 15 seconds if no buttons are pressed within 15 seconds.

**Auto 45 sec** . The menu will automatically be turned off in 45 seconds if no buttons are pressed within 45 seconds.

[Page 2]

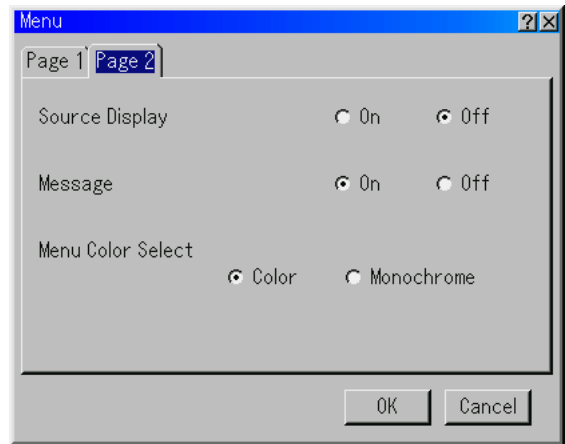

**Turning On / Off Source Display [Source Display]:**

This option turns on or off input name display such as RGB, DVI (DIGITAL/ANALOG), Video, and No Input to be displayed in the top right corner of the screen.

**Turning On / Off Message [Message]:**

This option turns on and off messages for lamp life warning, 3-minute before power off time, and "Please wait a moment".

**Selecting Menu Color [Menu Color Select]:**

You can choose between two color modes for menu color: color and monochrome.

**Setup**

Enables you to set operating options. Press "OK" to save your changes for all the features of Page1, Page2, Page3, Page 4 and Page 5.

[Page 1]

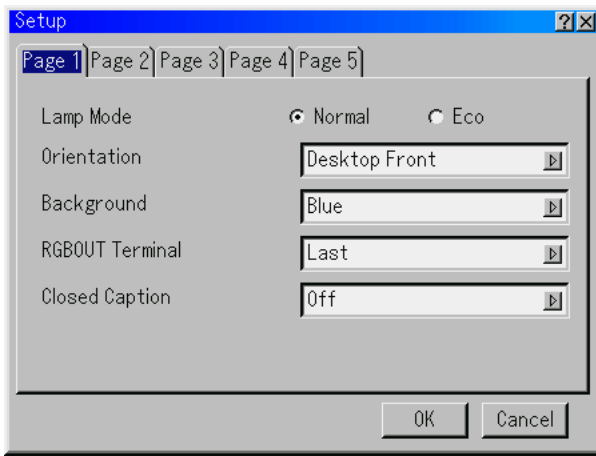

**Setting Lamp Mode to Normal or Eco [Lamp Mode]:**  
 This feature enables you to select two brightness mode of the lamp: Normal and Eco modes. The lamp life can be extended up to 3000 hours by using the Eco mode.

- Normal Mode ..... This is the default setting (100% Brightness).
- Eco Mode ..... Select this mode to increase the lamp life (80% Brightness).

**Selecting Projector Orientation [Orientation]:**  
 This reorients your image for your type of projection. The options are: desktop front projection, ceiling rear projection, desktop rear projection, and ceiling front projection.

**Selecting a Color or Logo for Background [Background]:**  
 Use this feature to display a blue/ black screen or logo when no signal is available. The default background is "Blue". You can change the logo screen using the PC Card Files feature. See pages 4-4 and 6-25 for Changing a logo.

**Setting RGB for RGB OUT [RGBOUT Terminal] (analog only):**  
 This option allows you to determine which RGB source is output from the RGBOUT connector during Idle mode.

- Last ..... The signal from the last RGB input will be output to the RGBOUT connector.
- RGB ..... The signal from RGB IN will be output to the RGBOUT connector.
- DVI (ANALOG) ..... The signal from DVI (ANALOG) IN will be output to the RGBOUT connector.

*NOTE: The AUDIO OUT mini jack will not output sound during the Idle mode.*

**Setting Closed Caption:**  
 This option sets several closed caption modes that allows text to be superimposed on the projected image.

- CAPTION 1-4 ..... Text is superimposed.
- TEXT 1-4 ..... Text is displayed in full screen.
- OFF ..... This exits the closed caption mode.

[Page 2]

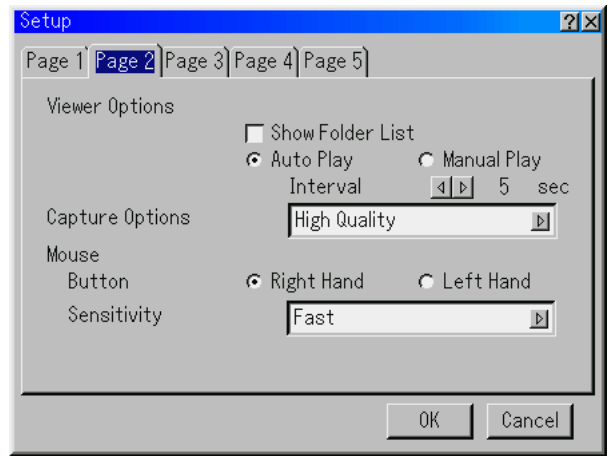

**Setting Viewer Options [Viewer Options]**  
**Show Folder List:**  
 If this option is checked, when the Viewer source is selected on the projector, the folder lists will be displayed and allows you to select the presentation from a PC card.

**Auto Play:**  
 If this option is checked, when the Viewer source is selected on the projector any given slide will start to play automatically.

**Auto Play Interval:**  
 You can specify interval time between 5 and 300 seconds.

*NOTE: The Auto Play Interval time set on "Slide Show Settings" of the Dynamic Image Utility 2.0 overrides the one set here.*

**Manual Play:**  
 Views a slide manually when the Viewer source is selected.

**Selecting Capture Options [Capture Option]:**  
 (available for JPEG only)  
 These options are used for the Capture function that you can select from Tools. You have three options for JPEG compression quality: High quality, Normal and High Compression.

- High Quality ..... Gives quality of JPEG a priority.
- Normal ..... Gives normal JPEG quality.
- High Compression ... Gives compression a priority.



Setting Mouse Button and Sensitivity [Mouse]:

This option lets you change your USB mouse settings. The mouse settings feature is available for USB mouse only. Choose the settings you want:

- Mouse Button ..... "Right Hand" or "Left Hand"
- Mouse Sensitivity .... "Fast", "Medium" or "Slow"

[Page 3]

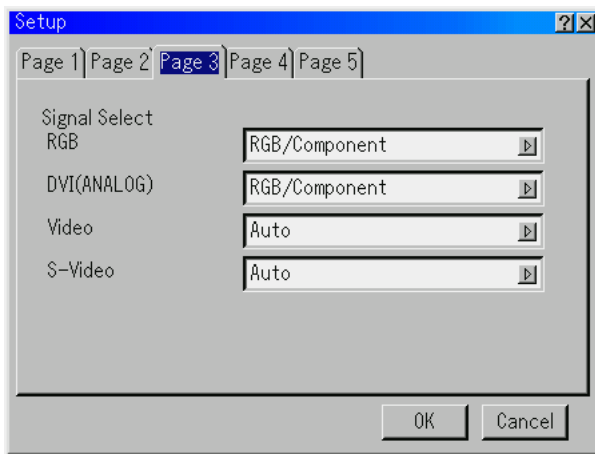

Selecting Signal Format [Signal Select]

RGB and DVI (ANALOG):

Allows you to choose "RGB" or "DVI (ANALOG)" for an RGB source such as a computer, or "Component" for a component video source such as a DVD player. Normally select "RGB/Component" and the projector automatically detects an either incoming signal. However there may be some component signals that the projector is unable to detect. If this is the case, select "Component". Select "Scart" in RGB for the European Scart.

VIDEO and S-VIDEO:

This feature enables you to select composite video standards manually. Normally select "Auto". Select the video standard from the pull-down menu. This must be done for Video and S-Video separately.

[Page 4]

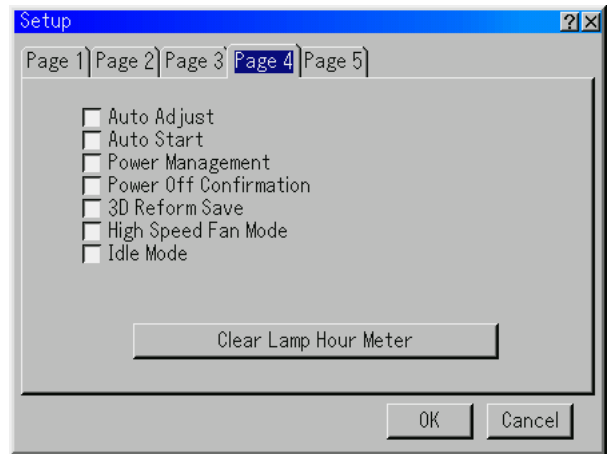

Enabling Auto Adjust [Auto Adjust]:

When "Auto Adjust" is set to "On", the projector automatically determines the best resolution for the current RGB input signal to project an image using NEC's Advanced AccuBlend Intelligent Pixel Blending Technology.

The image can be automatically adjusted for position and stability; "Horizontal Position", "Vertical Position", "Clock", "Phase", and "Resolution".

- On ..... Automatically adjusts image "Horizontal Position", "Vertical Position", "Clock", "Phase" and "Resolution".
- Off ..... User can adjust the image display functions ("Horizontal Position", "Vertical Position", "Clock", "Phase" and "Resolution") manually.

Enabling Auto Start [Auto Start]:

Turns the projector on automatically when the power cable is inserted into an active power outlet and the main power switch is turned on. This eliminates the need to always use the "Power" button on the remote control or projector cabinet.

Enabling Power Management [Power Management]:

When this option is on and there is no input for five minutes or more, the projector will automatically turn itself off.

Enabling Power Off Confirmation [Power Off Confirmation]:

This option determines whether a confirmation dialog for turning off the projector will appear or not.

*NOTE: When the confirmation message is displayed, you must be in the Projector mode to operate your projector using the remote control. If not, press the PJ button on the remote control to change your projector to the Projector mode. The button lights to indicate that you are in the Projector mode.*

**Enabling Horizontal and Vertical Keystone Correction Save [3D Reform Save]:**

This option enables you to save your current 3D Reform settings. Saving your change once affects all sources. The changes are saved when you turn off the projector.

**Enabling High Speed Fan Mode [High Speed Fan Mode]:**

This option allows you to select two modes for fan speed: high-speed mode and normal speed mode.

When you wish to cool down the temperature inside the projector quickly, check this box.

*NOTE: Enable High Speed Fan mode if you continue to use the projector for consecutive days.*

**Enabling Idle Mode [Idle Mode]:**

The projector has two standby modes: Idle and Standby.

Standby is the mode that allows you to put the projector in the standby condition which consumes less power than the idle mode. The projector is preset for Idle mode at the factory.

When this check box is turned on, you allow the RGB OUT connector to output RGB signal during Idle mode.

**NOTE:**

- \* The RGB OUT connector will not output signal during the Standby mode.
- \* Via the USB interface the projector can be turned on from your PC using Dynamic Image Utility 2.0 during the Idle or Standby mode. On the LAN connection the projector can be controlled or monitored from your PC using Dynamic Image Utility 2.0 only in the Idle mode.
- \* The HTTP server functions are not available during Standby mode.

**Clearing Lamp Hour Meter [Clear Lamp Hour Meter]:**

Resets the lamp clock back to zero. Pressing this button appears a confirmation dialog box. To reset the lamp usage hour, press "OK".

*NOTE: The projector will turn off and go into standby mode after 2100 hours (up to 3100 hours in Eco mode) of service. In this condition you cannot clear the lamp hour meter on the menu. If this happens, press the "Help" button on the remote control for ten seconds to reset the lamp clock back to zero. Do this only after replacing the lamp.*

[Page 5]

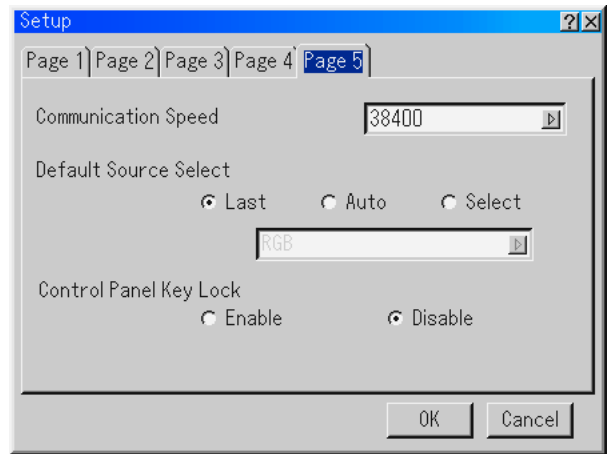

**Selecting Communication Speed [Communication Speed]:**

This feature sets the baud rate of the PC Control port (Mini DIN 8 Pin). It supports data rates from 4800 to 38400 bps.

The default is 38400 bps. Select the appropriate baud rate for your equipment to be connected (depending on the equipment, a lower baud rate may be recommended for long cable runs).

**Selecting Default Source [Default Source Select]:**

You can set the projector to default to any one of its inputs each time the projector is turned on.

**Last** ..... Sets the projector to default to the previous or last active input each time the projector is turned on.

**Auto** ..... Searches for an active source in order of RGB → DVI (DIGITAL) → DVI (ANALOG) → Video → S-Video → Viewer → RGB and displays the first found source.

**Select** ..... Displays the selected source input every time the projector is started up. Select an input from the pull-down menu.

**Disabling the Cabinet Buttons [Control Panel Key Lock]:**

This option turns on or off the Control Panel Key Lock function.

**NOTE:**

- \* This Control Panel Key Lock does not affect the remote control and the PC Control functions.
- \* When the cabinet buttons are disabled, pressing and holding the CANCEL button for about 10 seconds will change the setting to enabled.

**Selecting Aspect Ratio and Position for Screen [Screen]**

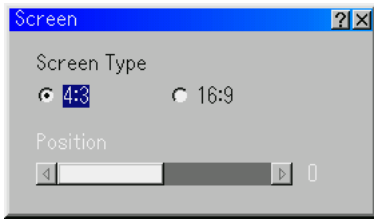

**Screen Type:**

Select either 4:3 Screen or 16:9 Screen for the screen to be used.

See also "Aspect Ratio" on page 6-8.

*NOTE: When "Resolution" is set to "Native", this selection is inactive.*

**Position:**

This feature adjusts the vertical position of the image when viewing video with an aspect ratio selected.

When some aspect ratios are selected in Image Options, the image is displayed with black borders on the top and bottom. You can adjust the vertical position between top and bottom.

*NOTE: This option is not available when "4:3" is selected in Screen Type and "Letterbox" is selected in Aspect Ratio.*

*NOTE: During 3D Reform adjustment, "Screen Type" and "Screen Position" may not be available. To make available, first reset the 3D Reform data and then do settings again. Secondly repeat the 3D Reform adjustment. Changing "Screen Type" and "Screen Position" can limit 3D Reform in its adjustable range.*

**Setting LAN Mode**

This feature allows you to set various setting items when the projector is used on your network.

Consult with your network administrator about these settings.

*NOTE: A LAN card is required for LAN connection; NEC's optional wireless LAN card is available. For more information on inserting or ejecting a LAN card, see page 5-1.*

**CAUTION: Make sure that the LAN card is removed during Standby mode (NOT Idle mode) or with the main power off. Failure to do so may cause damage to your LAN card.**

**IP Address**

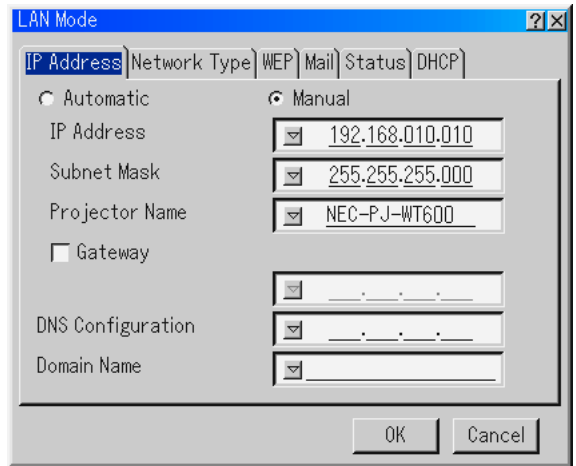

An IP address can be automatically assigned to this projector by your DHCP server. If your network does not automatically assign IP address, ask your network administrator for an address, and then register it manually.

- Automatic ..... Automatically assigns an IP address to the projector from a DHCP server.
- Manual ..... Provides a space for you to register the IP address or subnet mask number obtained from your network administrator.
- IP Address ..... Set your IP address. Press to display the software keyboard and type in 12 numeric characters.
- Subnet Mask ..... Set your subnet mask number. Press to display the software keyboard and type in 12 numeric characters.
- Projector Name ..... Specify a unique projector name. Press to display the software keyboard and type in. Up to 16 alphanumeric characters can be used.
- Gateway ..... Set the default gateway of the network connected to the projector. Press to display the software keyboard and type in 12 numeric characters.

Checking this box will make the set default route valid. When data is sent from the LAN card, the transfer location will be searched according to the previously set routing information; however, when the transfer location has not been found as a result of the search, the data will be sent to the device that holds the IP address set here. The IP address that is set here must be one that can be identified by a search of the routing information.

**DNS Configuration**

..... Type in the IP address of DNS server on the network connected to the projector. 12 numeric characters are used.

Domain Name ..... Type in domain name of the network connected to the projector. Up to 60 alphanumeric characters can be used.

**Channel:**

Set this option when selecting [802.11 Ad Hoc] or [Ad Hoc] in [Mode].

Select a channel number from the pull-down list. The channel must match for all wireless devices communicating on your wireless LAN.

*NOTE: Channels in the pull-down list are different depending on which country you live in.*

**TX rate:**

Select a wireless transmission speed. Normally leave it as Automatic. Try another transmission speed when the connection fails.

**WEP (for Wireless only)**

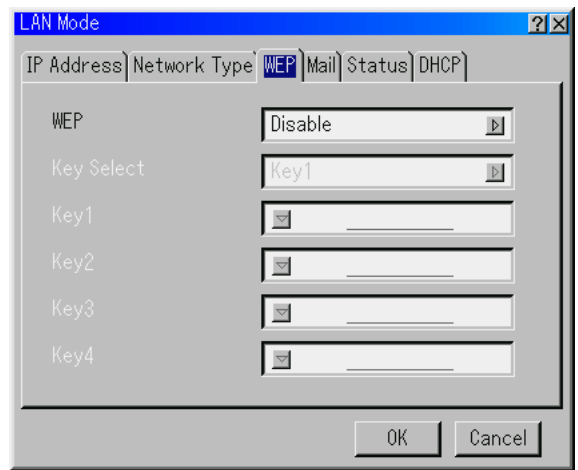

Select this option whether using the WEP (Wired Equivalent Privacy) key for encryption or not. To use encryption, specify WEP key.

Disable ..... Will not turn on the encryption feature. Your communications may be monitored by someone.

64bit ..... Uses 64-bit datalength for secure transmission.

128bit ..... Uses 128-bit datalength for secure transmission. This option will increase privacy and security when compared to use of 64bit datalength encryption.

*NOTE: The WEP settings must be the same as communication devices such as PC or access point in your wireless network. When you use WEP, your image transmission speed will slow down.*

**Key Select:**

Selects one key from the four keys below when selecting [64bit] or [128bit] in [WEP].

**Network Type (required for wireless only)**

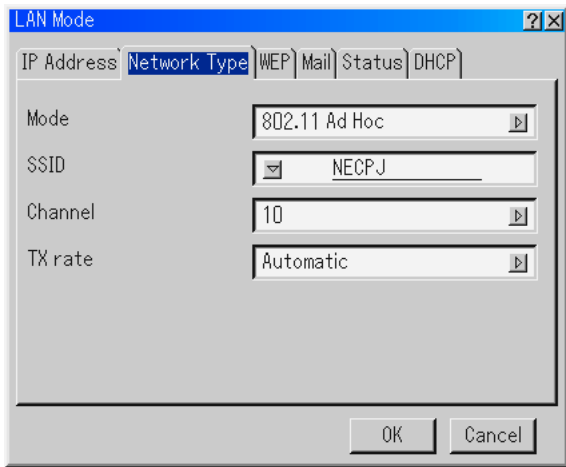

**Mode:**

Select communication method when using wireless LAN.

Infrastructure ..... Select this option when communicating with one or more equipment connected to the wireless or wired LAN network via an access point.

802.11 Ad Hoc ..... Select this option when using the wireless LAN to communicate with a computer in a one-to-one correspondence. This is a method that meets the IEEE802.11 wireless standard.

Ad Hoc ..... Select this option when using the wireless LAN to communicate with a computer in a one-to-one correspondence.

Easy Connection ..... This allows you to easily set up wireless LAN connection. See the supplied Software Utility Installation Guide for more information.

**SSID (Network name):**

Enter an identifier (SSID) for wireless LAN. Communication can be done only with equipment whose SSID matches SSID for your wireless LAN. Up to 32 alphanumeric characters can be used (Case-sensitive).

*NOTE: To disable SSID, select a space (null) or "ANY"(All caps).*

**Key1-4:**

Enter encryption key when selecting [64bit] or [128bit] in [WEP].

Up to 5 characters can be set in 64 bit and up to 13 characters in 128 bit. Press the "HEX" button in the Software keyboard to change to "ASCII" to set the key in ASCII digit. You can toggle this button between "ASCII" and "HEX".

When setting the key in hexadecimal digit:

- \* The "0x (numeral and alphabet respectively) appears automatically right in front of your key code.
- \* Hexadecimal uses 0 to 9 and A to F.
- \* Up to 10 characters can be set in 64 bit and up to 26 characters in 128 bit.

**SMTP Server Name:**

Type in the SMTP server name to be connected to the projector. Up to 60 alphanumeric characters can be used.

**Recipient's Address 1 to 3:**

Type in your recipient's address. Up to 60 alphanumeric and symbols characters can be used.

**Test Mail:**

Send a test mail to check if your settings are correct.

*NOTE: If you entered an incorrect address in a test, you may not receive an Alert mail. Should this happen, check if the Recipient's Address is correctly set.*

*NOTE: Unless any one of the "Sender's Address", "SMTP Server's Name" or "Recipient's Address 1-3" is selected, "Test Mail" is not available.*

*NOTE: Be sure to highlight "OK" and press the ENTER button before executing "Test Mail".*

**Mail**

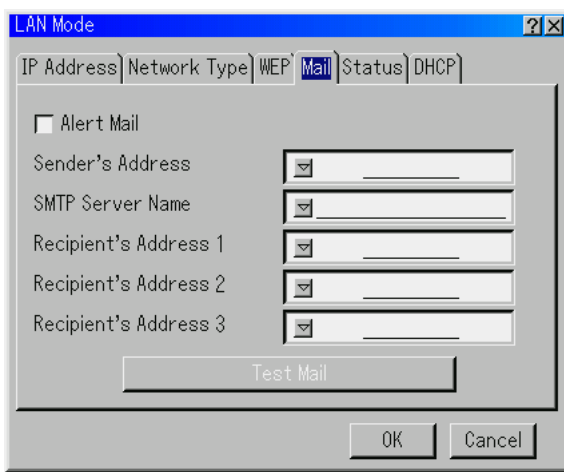

*NOTE: To the Mail Alert feature on wireless LAN connection, select "Infrastructure" for "Mode" in "Network Type." "Test Mail" is available only when there is a LAN card in the PC card slot of the projector.*

**Alert Mail:**

Checking this box enables Alert Mail feature.

This option notifies your computer of an error message via e-mail when using wireless or wired LAN. The error message will be notified when the projector lamp has reached the end of its usable life or an error occurs in the projector.

**Sample of a message sent from the projector:**

The lamp is at the end of its usable life. Please replace the lamp.

Projector Name: X X X X

Lamp Hour Meter: xxxx [H]

Projector Usage: xxxxxx [H]

**Sender's Address:**

Specify the senders address. Use the Software keyboard. Up to 60 alphanumeric and symbols characters can be used. See "Using Software Keyboard" in Appendix for more details.

Status

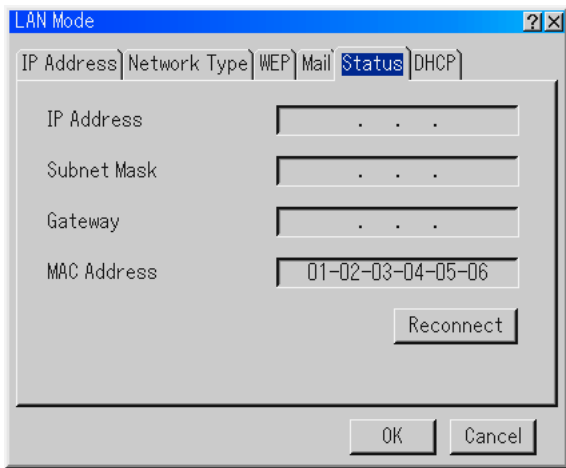

Displays the status of the LAN settings.

- IP Address ..... Indicates the IP address of the projector.
- Subnet Mask ..... Indicates the subnet mask of the projector.
- Gateway ..... Indicates the gateway of the network connected to the projector.
- MAC Address ..... Indicates the MAC address of the LAN card.
- Reconnect ..... Use this button to connect the projector to a network.

changes to the following settings.

Host Name option

- Select whether or not to add option hostname for DHCP.
- None ..... Not add
- Request ..... Add at the time of DHCP\_REQUEST.
- Discover/Request .... Add at the time of DHCP\_DISCOVER and DHCP\_REQUEST.

Host Name

Type in a hostname. This field is available only when "Request" or "Discover/Request."

Client-identifier option

- Select whether or not to add option client identifier for DHCP.
- None ..... Not add
- Request ..... Add at the time of DHCP\_REQUEST.
- Discover/Request .... Add at the time of DHCP\_DISCOVER and DHCP\_REQUEST.

Use MAC address

Turn on to use MAC address for Client-identifier.

Client-identifier

Type in a client identifier.

DHCP

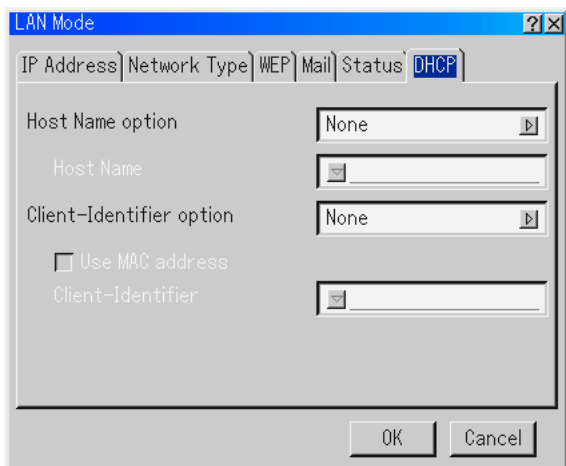

Depending on your network environment, acquiring an IP address from a DHCP server may not be possible. Should this happen, consult your network administrator to make

**Setting a Password**

A password can be set for your projector to avoid operation by an unauthorized person.

There are two password options: one for menu and the other for logo.

When a password is set, doing any one of the following four operations will display the Password input screen.

For Menu:

- \* Changing the menu to Advanced
- \* Editing the custom menu

For Logo:

- \* Changing the background
- \* Changing the logo data in PC Card Files

Procedures for Password setting apply to both Menu and Logo.

**Entry**

To assign your password:



*NOTE: Up to 15 alphanumeric characters can be assigned.*

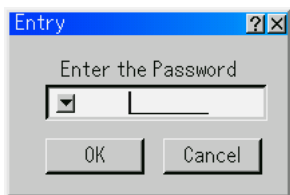

1. Type a password.  
Highlight "Entry" and press the ENTER button.  
The "Enter the Password screen" will be displayed.

Make sure that "▼" is highlighted and then press the ENTER button.  
The Software keyboard appears. Use the Software keyboard to type a password and then highlight "OK" on the "Enter the Password" screen and press the ENTER button.  
The [Confirm Password] screen will be displayed.

2. Type the same password again. Highlight "OK" on the "Enter the Password" screen and press the ENTER button.

Your password will be assigned.

**Delete**

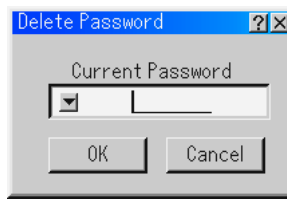

To delete your password:

1. Highlight [Delete] and press the ENTER button. The "Current Password" screen will be displayed.
2. Use the Software keyboard to type your password. Highlight "OK" on the "Current Password" screen and then press the ENTER button.

Your password will be deleted.

In case you forget your password, follow the steps below to delete it.

1. Select the Advanced menu from the Basic menu. The "Password" entry screen will be displayed.
2. Use the Software keyboard to type "1111".  
Highlight "OK" on the "Password" entry screen and then press the ENTER button.  
The "Password Warning!!" message will be displayed.
3. Use the Software keyboard to type "3333".  
Highlight "OK" on the "Password" entry screen and then press the ENTER button.  
The "Password Warning!!" message will be displayed.
4. Use the Software keyboard to type "5555".  
Highlight "OK" on the "Password" entry screen and then press the ENTER button.  
The "Delete Password. Are you sure? Yes/No" dialog box will be displayed.
5. Use the SELECT ◀ or ▶ button to highlight "Yes" and press the ENTER button.

Your password will be deleted.

**Security**

The Security function enables you to protect your projector so that the projector will not project a signal unless you enter a keyword. There is also an option to lock the projector by using a registered PC card as a protect key. Once you have registered your PC card as a protect key, you are required to insert the registered PC card into the PC card slot of the projector each time you turn on the projector. You can enable the Security function by using a keyword only.

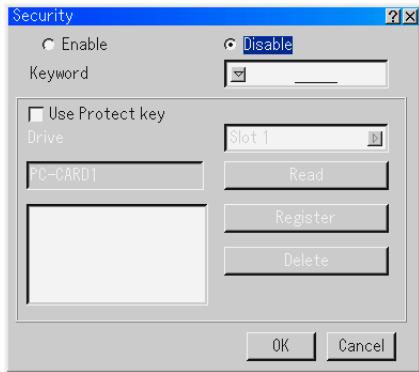

- Enable/Disable ..... This turns the Security function on or off.
- Keyword ..... Enter an appropriate keyword when you use the Security function.  
(Up to 10 characters can be used.)
- The Security function is available only when your keyword is entered.
- Use Protect key ..... Check this box to lock your projector when using a PC card. To use a keyword without a PC card, do not check this box.
- Drive ..... Switches between PC Card slots.
- Read ..... Reads data of a PC card.
- Register ..... Registers data of the PC card.  
The Security function is not available unless at least one PC card is registered. (if the "Use Protect key" check box is selected) Up to 5 PC cards can be registered.
- Delete ..... Deletes data of a registered PC card.

To set up a keyword to enable the Security function without using a registered PC card.

1. Use the SELECT ▲▼ button to select "Keyword" and use the software keyboard to enter a keyword.

*NOTE: Please make a note of your keyword.*

2. Use the SELECT ▲▼ button to select "Enable" and use the SELECT ▲▼ button to select "OK", then the Security function will be enabled. An "Are you sure?" message will appear. Use the SELECT ◀▶ button and press the ENTER button. The Security function takes effect.

To register a PC card as a protect key.

1. Insert a PC card into the PC card slot of the projector.
2. Use the SELECT ▲▼ button to select "Use Protect key" and press the ENTER button. A check mark will be placed.
3. Use the SELECT ▲▼ button to select "Read" and press the ENTER button.  
Data of the PC card will be read into the projector.
4. Use the SELECT ▲▼ button to select "Register" and press the ENTER button.  
Downloaded data will be registered and be displayed in the list window.
5. Use the SELECT ▲▼ button to select "Keyword" and use the software keyboard to enter a keyword.

*NOTE: To use a PC card as a protect key, you must also set up a keyword. Please make a note of your keyword.*

This completes registration of your PC card.

To enable Security, use the SELECT ▲▼ button to select "Enable" and use the SELECT ▲▼ button to select "OK" and "Security function will be enabled. An "Are you sure?" message will appear. Use the SELECT ◀▶ button and press the ENTER button. The Security function takes effect.

To turn on the projector when Security is enabled (when using your keyword only).

1. Press and hold the POWER button for a minimum of two seconds.  
The projector will be turned on and display a message to the effect that the projector is security-protected.
2. Select [Projector Options] → [Security] from the menu and press the ENTER button.  
The Release Code input screen will be displayed.
3. Enter your keyword in the Release Code input screen.  
You can view the projected image.

*NOTE: Do not forget your keyword. However, if you forget your keyword, NEC or your dealer will provide you with your Release Code. See more information at the end of this section.*



To turn on the projector when Security is enabled (when using a PC card as a protect key).

1. Insert your registered PC card into the PC card slot.
  2. Press and hold the POWER button for a minimum of two seconds.  
The projector will turn on and then recognize the PC card. Once the image has been projected, it will stay on without the PC card.
- The security disable mode is maintained until the main power is turned off (by setting the main power switch to "O" or unplugging the power cable).  
In the following cases you will be asked to check the protect key or input the keyword:
    - (1) When "OK" is selected at an image for which security is set and the power is turned off then back on
    - (2) When the main power is turned off then back on while the security function is enabled
    - (3) When you attempt to display an image for which security is set while the security function is enabled
  - Blanks (spaces) cannot be used in the Keyword section.

To delete PC card data you registered.

1. Use the SELECT ▲▼ button to select "Delete" and use the SELECT ◀ button to select the list window.
2. Use the SELECT ▲▼ button to select the PC card data you wish to delete.
3. Press the SELECT ▶ button to select "Delete" and press the ENTER button.  
The PC card data will be deleted.

If you've lost your registered PC card, proceed as follows:

---

*NOTE: NEC or your dealer will provide you with your Release Code in exchange for your registered keyword and Request Code. See URLs at the end of this section.*

---

1. Press and hold the POWER button for a minimum of two seconds.  
The projector will be turned on and display a message to the effect that the projector is security-protected.
2. Select [Projector Options] → [Security] from the menu and press the ENTER button.  
The Release Code input screen will be displayed as well as your Request Code (24 alphanumeric characters).
3. Enter your Release Code in the Release Code Input screen.

- \* If the projector is turned on by entering the Release Code, your Security will be disabled.

---

**NOTE:**

- \* Some types of PC cards cannot be registered as your protect key.
  - \* It is recommended that you register two or more PC cards in case you lose or damage your registered PC card.
  - \* Formatting your registered PC card will disable your protect key function.
- 

**NOTE:**

For additional information visit:

US : <http://www.necvisualsystems.com>

Europe : <http://www.nec-europe.com/>

Global : <http://www.nec-pj.com/>

---

**Tools**

Provides tools for setting sleep timer, capturing images, displaying files or changing your background logo in a PC Card and drawing.

*NOTE: The "Capture" and "PC Card Files" features are required for a PC card.*

**Using Sleep Timer**

1. Select your desired time between 30 minutes and 16 hours: Off, 0:30, 1:00, 2:00, 4:00, 8:00, 12:00, 16:00.
2. Select "Set" and press the ENTER button on the remote control.
3. The remaining time starts counting down.
4. The projector will turn off after the countdown is complete.

*NOTE:*

- To cancel the preset time, set "Off" for the preset time or turn off the power.
- When the remaining time reaches 3 minutes before the projector is turned off, the "Projector will turn off in 3 minutes" message will be displayed on the bottom of the screen.

**Using Capture**

Allows you to capture an image from a source that is currently being displayed. The image is saved as JPEG in the PC card. When you select Capture from the menu, you will get a tool bar. You can capture an image directly using the tool bar when the menu is not displayed. See page 5-3.

**Using PC Card Files**

The PC Card Files feature allows you to display a list of all the files stored in the PC card so that you can select a file you want to display. You can also sort files by file name or date, or display the file. See page 5-4.

**Changing Background Logo:**  
You can change the default background logo using the PC Card Files feature.

*NOTE: File size must be 256KB or less. Other file formats than JPEG and BMP are not available. See page 4-4.*

**Using ChalkBoard**

The ChalkBoard feature allows you to write and draw messages on a projected image. See page 4-4.

*NOTE: This feature is available only when using with USB mouse. See page 4-3.*

**Help**

**Contents**

Provides an online help about how to use the menus. An underlined link means that you can move to an adjustment item directly. Selecting the underlined link and pressing ENTER moves to the corresponding adjustment item.

**Information**

Displays the status of the current signal, and the lamp and the projector usage hours. This dialog box has three pages. The information included are as follows:

*NOTE: The progress indicator shows the percentage of remaining bulb life. The value informs you of the amount of lamp and projector usage respectively.*

[Page 1]	[Page 2]	[Page 3]
Source Name	Signal Type	Remaining Lamp Time (%)
Input Terminal	Video Type	Lamp Hour Meter (H)
Entry No.	Sync Type	Projector Usage (H)
Horizontal Frequency	Interlace	
Vertical Frequency		
Sync Polarity		

**Remaining Lamp Time Display**

When the remaining lamp time reaches 0, the Remaining Lamp Time bar indicator changes from 0% to 100 Hours and starts counting down. If the remaining lamp time reaches 0 hours, the projector will not turn on regardless of whether the lamp mode is set to Normal or Eco.

**Returning to Factory Default**

The Factory Default feature allows you to change adjustments and setting to the factory preset for source.

All Data .....	Resets all the adjustments and settings for all the signals to the factory preset except Remaining Lamp Time, Lamp Hour Meter, Projector Usage, Language, Background, Idle mode, Communication Speed, LAN Mode, Security and Password. Including Entry List: Also deletes all the signals in the Entry List and returns to the factory preset.
Current Signal .....	Resets the adjustments for the current signal to the factory preset levels. All the items in "Picture", "Volume", "Image Options" and "Picture Management" can be reset.

# 7. Maintenance

This section describes the simple maintenance procedures you should follow to replace the lamp, and to clean the cabinet and the mirror.

## 7-1. Replacing the Lamp

After your lamp has been operating for 2000 hours (up to 3000 hours : Eco mode) or longer, the "Lamp" indicator in the cabinet will blink red and the message will appear. Even though the lamp may still be working, replace it at 2000 hours (up to 3000 hours : Eco mode) to maintain optimal projector performance.

### CAUTION

- **DO NOT TOUCH THE LAMP** immediately after it has been used. It will be extremely hot. Turn the projector off, wait 90 seconds, turn off the main power switch, and then disconnect the power cable. Allow at least one hour for the lamp to cool before handling.
- **DO NOT REMOVE ANY SCREWS** except the lamp cover screw and two lamp case screws. You could receive an electric shock.
- The projector will turn off and go into stand by mode after 2100 hours (up to 3100 hours : Eco mode) of service. If this happens, be sure to replace the lamp. If you continue to use the lamp after 2000 hours (up to 3000 hours : Eco mode) of use, the lamp bulb may shatter, and pieces of glass may be scattered in the lamp housing. Do not touch them as the pieces of glass may cause injury. If this happens, contact your NEC dealer for lamp replacement.

To replace the lamp:

1. Loosen the lamp cover screw until the screwdriver goes into a freewheeling condition and remove the lamp cover. The lamp cover screw is not removable.

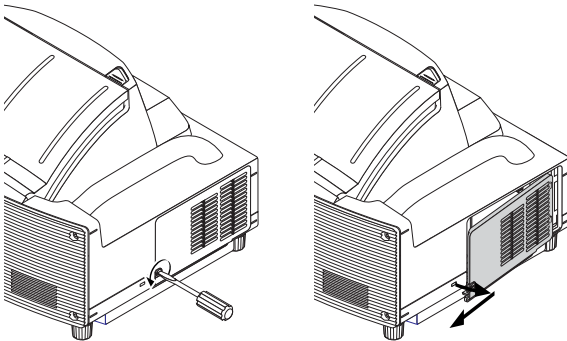

2. Loosen the two screws securing the lamp housing until the screwdriver goes into a freewheeling condition. The two screws are not removable.

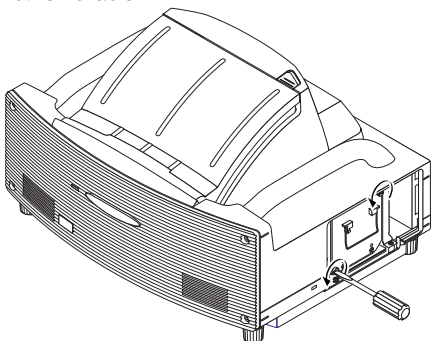

3. Remove the lamp housing by pulling out the handle.

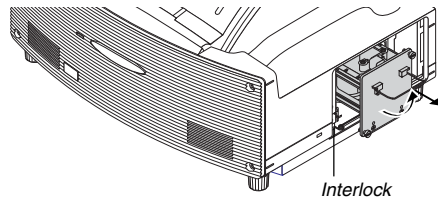

*NOTE: There is an interlock on this case to prevent the risk of electrical shock. Do not attempt to circumvent this interlock.*

4. Insert a new lamp housing until the lamp housing is plugged into the socket.

**CAUTION: Do not use a lamp other than the NEC replacement lamp (LT60LPK).**

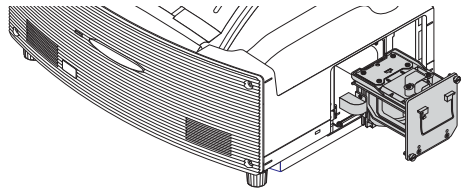

5. Secure it in place with the two screws. Be sure to tighten the screws.

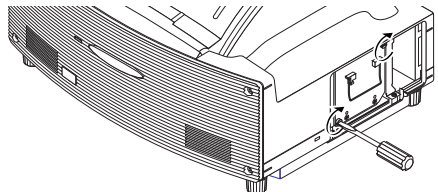

6. Reattach the lamp cover.

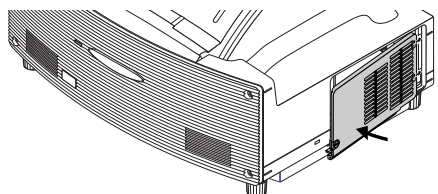

7. Tighten the lamp cover screw. Be sure to tighten the screw.

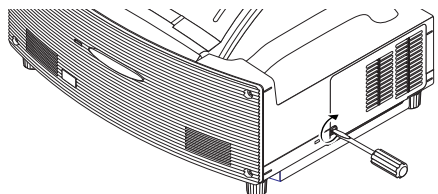

8. After you install a new lamp, from the menu select [Projector Options] → [Setup] → [Page 4] → [Clear Lamp Hour Meter] to reset the lamp usage hours. If the projector will not be turned on after using 2100 hours (up to 3100 hours : Eco mode) of service, press and hold the [Help] button on the remote control for ten seconds or longer to reset the lamp time clock to zero.

## 7-2. Cleaning

### Cleaning the Cabinet

1. Turn off the projector before cleaning.
2. Clean the cabinet periodically with a damp cloth. If heavily soiled, use a mild detergent. Never use strong detergents or solvents such as alcohol or thinner.

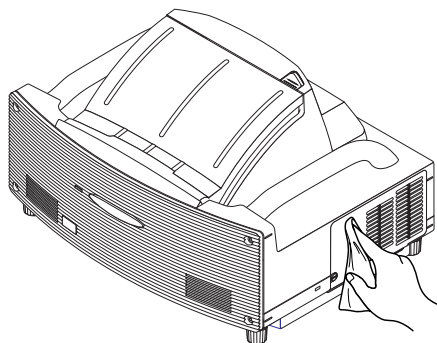

- \* The projector has a sensor which detects an object in front of the largest mirror or in the light path. If the sensor detects any object, the projector will not turn on. If this happens while the projector is turned on, the image is muted. In either case the STATUS indicator flashes in red.
- \* The projector has a temperature sensor which detects excessive heat. If the sensor detects heat in the bottom of the mirror or in the light path, the projector will not turn on. If this happens while the projector is turned on, the projector will turn off (the idle mode). In either case the STATUS indicator flashes in red.

### Handling and Care of Mirror surface

If the projector is not to be used for an extended period of time, close the mirror cover. This will protect the projector against dropping an object or gathering dust.

Consult with your dealer when using the projector exposed to smoke or dust. Long-term exposure to sulfide can corrode the mirror surface.

#### Cleaning the mirror face

Keep finger prints off the mirror surface. Do not scratch the mirror surface with a hard or pointed object. Leaving a defect in the mirror surface might cause an unwanted shadow and poor picture quality.

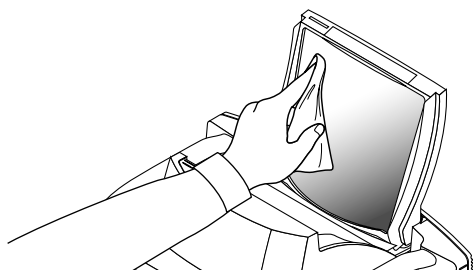

If the mirror surface is soiled with fingers prints or dust, wipe them off with the supplied cleaning cloth. When removing sandy dust, use a blower to blow off dust or brush it off softly and wipe the mirror surface with the supplied cleaning cloth.

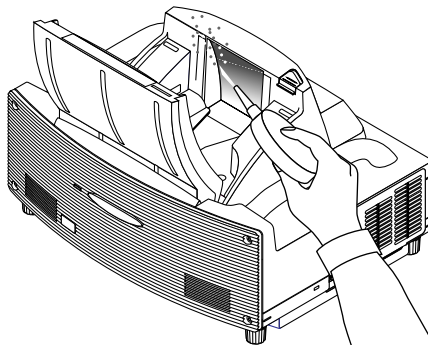

Do not blow your breath against the mirror surface, which can accidentally put your saliva on the mirror surface. Leaving foreign grease stains, oil-smudged finger prints or salt on the mirror surface can cause damage to the reflective coating on the mirror surface. Use only the supplied cleaning cloth to clean the mirror surface. Failure to do so can mar the mirror surface.

Do not force the cleaning cloth against the mirror surface or apply excessively strong pressure against it. Do not scratch it with your nails while wiping off.

Never use strong detergents or solvents such as thinner or benzene. Doing so can corrode the reflective coating on the mirror surface. If heavily soiled and wiping with the cleaning cloth will not work, use absolute alcohol. After the mirror surface is dried, wipe it with the cleaning cloth again.

If the supplied cleaning cloth is soiled, wash it. It is recommended you wash it every after two to three uses. Do not allow long-term close contact with rubber or vinyl products because this could cause the reflective coating of the mirror surface to deteriorate.

Do not spray volatile substances such as insect repellent on the mirror surface.

# 8. Troubleshooting

This section helps you resolve problems you may encounter while setting up or using the projector.

## 8-1. Power Indicator

Indicator Condition			Projector Condition	Note
Off			The main power is off	–
Blinking light	Green blinking	0.5 sec ON, 0.5 sec OFF	The projector is getting ready to turn on.	Wait for a moment.
		2.5 sec ON, 0.5 sec OFF	The projector is in Sleep Timer mode.	–
	Orange blinking	0.5 sec ON, 0.5 sec OFF	The projector is cooling down.	Wait for a moment.
Steady light	Green		The projector is turned on.	–
	Orange		The projector is in Idle or Standby.	–

## 8-2. Status Indicator

Indicator Condition			Projector Condition	Note
Off			Normal	–
Blinking light	Red blinking	1 cycle (0.5 sec ON, 2.5 sec OFF)	Lamp cover error	Replace the lamp cover correctly.
			Mirror cover error	Make sure the mirror cover is open. Projector cannot be turned on with the mirror cover closed.
		2 cycle (0.5 sec ON, 0.5 sec OFF)	Temperature error	The projector is overheated. Move the projector to a cooler location.
			Temperature error due to dust	Remove dust in the light path.
		3 cycle (0.5 sec ON, 0.5 sec OFF)	Power error	Power unit will not work correctly.
	4 cycle (0.5 sec ON, 0.5 sec OFF)	Fan error	Fans will not work correctly.	
	6 cycle (0.5 sec ON, 0.5 sec OFF)	Lamp error	Lamp fails to light. Wait a full minute and then turn on again.	
	Green blinking	Re-firing the lamp	The projector is re-firing.	
Steady light	Orange	Control key locked	You have pressed control panel key when Control Key Lock is enabled.	
	Red	A hand or an object blocks the light path.	Remove it from the light path.	
	Green	Idle condition	–	

## 8-3. Lamp Indicator

Indicator Condition		Projector Condition	Note
Off		Normal	–
Blinking light	Red	Lamp has reached its end of life. Lamp replacement message will be displayed.	Replace the lamp.
Steady light	Red	Lamp has been used beyond its limit. The projector will not turn on until the lamp is replaced.	Replace the lamp.
	Green	Lamp mode is set to Eco mode	–

## 8-4. Common Problems & Solutions

Problem	Check These Items
Does not turn on	<ul style="list-style-type: none"> <li>• Check that the power cable is plugged in and that the power button on the projector cabinet or the remote control is on. See pages 2-7 and 3-1.</li> <li>• Ensure that the lamp cover is installed correctly. See page 7-1.</li> <li>• Check to see if the projector has overheated or the lamp usage exceeds 2100 hours (up to 3100 hours : Eco mode). If there is insufficient ventilation around the projector or if the room where you're presenting is particularly warm, move the projector to a cooler location.</li> <li>• Check to see if the Control Panel Key Lock function is enabled. If this function is enabled, cancel it by pressing and holding the CANCEL button on the cabinet for a minimum of 10 seconds or using the menu. See page 6-17.</li> </ul>
No picture	<ul style="list-style-type: none"> <li>• Use the menus or SOURCE button to select your source (RGB, DVI (DIGITAL), DVI (ANALOG), Video, S-Video, Viewer or LAN). See page 3-2 or 6-6.</li> <li>• Ensure your cables are connected properly.</li> <li>• Use menus to adjust the brightness and contrast. See page 6-7.</li> <li>• Open the mirror cover. See page 1-3.</li> <li>• Reset the settings or adjustments to factory preset levels using the Factory Default in the Adjustment Menu. See page 6-25.</li> <li>• When using with a notebook PC, be sure to connect between the projector and the notebook PC before turning on the power to the notebook PC. In most cases signal cannot be output from RGB output unless the notebook PC is turned on after connecting with the projector. <ul style="list-style-type: none"> <li>* If the screen goes blank while using your notebook PC, it may be the result of the computer's screen-saver or power management software.</li> <li>* If you accidentally hit the POWER button on the remote control, wait 90 seconds and then press the POWER button again to resume.</li> </ul> </li> </ul> <p>To project a DVI digital signal, be sure to connect the PC and the projector using the DVI-D signal cable (supplied) before turning on your PC or projector. Turn on the projector first and select DVI (DIGITAL) from the source menu before turning on your PC.</p> <p>Failure to do so may not activate the digital output of the graphics card resulting in no picture being displayed. Should this happen, restart your PC.</p> <p>Do not disconnect the DVI-D signal cable while the projector is running. If the signal cable has been disconnected and then reconnected, an image may not be correctly displayed. Should this happen, restart your PC.</p>
Image isn't square to the screen	<ul style="list-style-type: none"> <li>• Reposition the projector to improve its angle to the screen. See page 3-2.</li> <li>• Use the 3DReform function to correct the trapezoid distortion. See page 6-10 to 6-13.</li> </ul>
Picture is blurred	<ul style="list-style-type: none"> <li>• Adjust the focus. See page 3-3.</li> <li>• Reposition the projector to improve its angle to the screen. See page 3-2.</li> <li>• Ensure that the distance between the projector and screen is within the adjustment range of the mirror. See page 2-2.</li> <li>• Condensation may form on the mirror if the projector is cold, brought into a warm place and is then turned on. Should this happen, let the projector stand until there is no condensation on the mirror.</li> </ul>
Image is scrolling vertically, horizontally or both	<ul style="list-style-type: none"> <li>• Use the menus or SOURCE button on the remote control or the cabinet to select the source you want to input.</li> </ul>
Remote control does not work	<ul style="list-style-type: none"> <li>• Install new batteries. See page 1-8.</li> <li>• Make sure there are no obstacles between you and the projector.</li> <li>• Stand within 22 feet (7 m) of the projector. See page 1-8.</li> <li>• Make sure that you are in the Projector mode and the PJ button lights in red. If not, press the PJ button. See page 4-1.</li> </ul>
Indicator is lit or blinking	<ul style="list-style-type: none"> <li>• See the Status Indicator on page 8-1.</li> </ul>
Cross color in RGB mode	<ul style="list-style-type: none"> <li>• If Auto Adjust is off, turn it on or adjust the image manually with the Position/Clock in the Image Options. See pages 6-8 and 6-16.</li> </ul>
USB mouse does not work	<ul style="list-style-type: none"> <li>• Make sure that your USB mouse is properly connected to the projector. The projector may not support some brands of a USB mouse.</li> </ul>

For more information contact your dealer.

# 9. Specification

---

This section provides technical information about the WT600 Projector's performance

**Model Number** **WT600**

## Optical

DMD	Single Chip Digital Micromirror Device (DMD)
Resolution	1024 × 768 pixels* up to UXGA (up to SXGA for digital signal) with Advanced AccuBlend
Mirror	Aspherical mirror × 4
Lamp	220 W DC standard (176W Eco mode)
Image Size	40" - 100" (1.0 m - 2.5 m) diagonal
Projection Distance	2.52" - 25.94" / 64 mm - 659 mm
Projection Angle	55°

## Electrical

Inputs	1 RGB, 1 DVI-I , 1 S-Video, 1 Video, 1 PC Card, 2 Stereo Mini Audio, 1 (L/R) RCA Audio, 1 PC Control, 1 Remote Control
Outputs	1 RGB, 1 Stereo Mini Audio
USB Port	1 A Type, 1 B Type
Video Compatibility	NTSC, NTSC4.43, PAL, PAL-60, PAL-N, PAL-M, SECAM, HDTV:1080i, 720p, 480p, 480i (w/optional cable)
Scan Rate	Horizontal: 15 kHz to 100 kHz (RGB: 24 kHz or over) Vertical: 50 Hz to 120 Hz
Video Bandwidth	RGB: 100 MHz (-3dB)
Pixel Clock Freq	Less than 135 MHz
Color Reproduction	16.7 million colors simultaneously, Full color
Horizontal Resolution	NTSC / NTSC4.43/PAL / YCbCr: 540 TV lines SECAM: 300 TV lines RGB: 1024 dots (H) × 768 dots (V)
External Control	RS232, IR, LAN (optional)
Sync Compatibility	Separate Sync / Composite Sync / Sync on G
Built-in Speakers	5 cm × 7 cm Oval type (× 2)
Sound Output Power	1W × 2
Power Requirement	100 - 120V AC / 200 - 240V AC, 50 / 60 Hz
Input Current	3.2A (100 - 120V AC) / 1.6A (200 - 240V AC)
Power Consumption	290W (0.6W at Standby)

\* Effective pixels are more than 99.99%.

**Mechanical**

Installation Orientation	Desktop/Front, Desktop/Rear, Ceiling/Front, Ceiling/Rear
Dimensions	15.0" (W) × 12.3" (H) × 12.3" (D) (with the mirror cover open)
	15.0" (W) × 8.9" (H) × 11.7" (D) (with the mirror cover closed)
	380 mm (W) × 313 mm (H) × 313 mm (D) (with the mirror cover open)
	380 mm (W) × 227 mm (H) × 296 mm (D) (with the mirror cover closed)
Net Weight	13.0 lbs / 5.9 kg
Environmental Considerations	Operational Temperatures: 41° to 95°F (5° to 35°C), 20% to 80% humidity (non-condensing) Storage Temperatures: 14° to 122°F (-10° to 50°C), 20% to 80% humidity (non-condensing)
Regulations	UL Approved (UL 1950, CSA 950) Meets DOC Canada Class B requirements Meets FCC Class B requirements Meets AS/NZS Cispr22 : 2002 Class B Meets EMC Directive (EN55022, EN55024, EN61000-3-2, EN61000-3-3) Meets Low Voltage Directive (EN60950, TUV GS Approved) CE

For additional information visit:

US : <http://www.necvisualsystems.com>

Europe : <http://www.nec-europe.com/>

Global : <http://www.nec-pj.com/>

Digital Light Processing and DLP are trademarks of Texas Instruments.

The specifications are subject to change without notice.



The DLP™ logo and DLP™ medallion are trade marks of Texas Instruments.



# 10. Appendix

## 10-1. Cabinet Dimensions

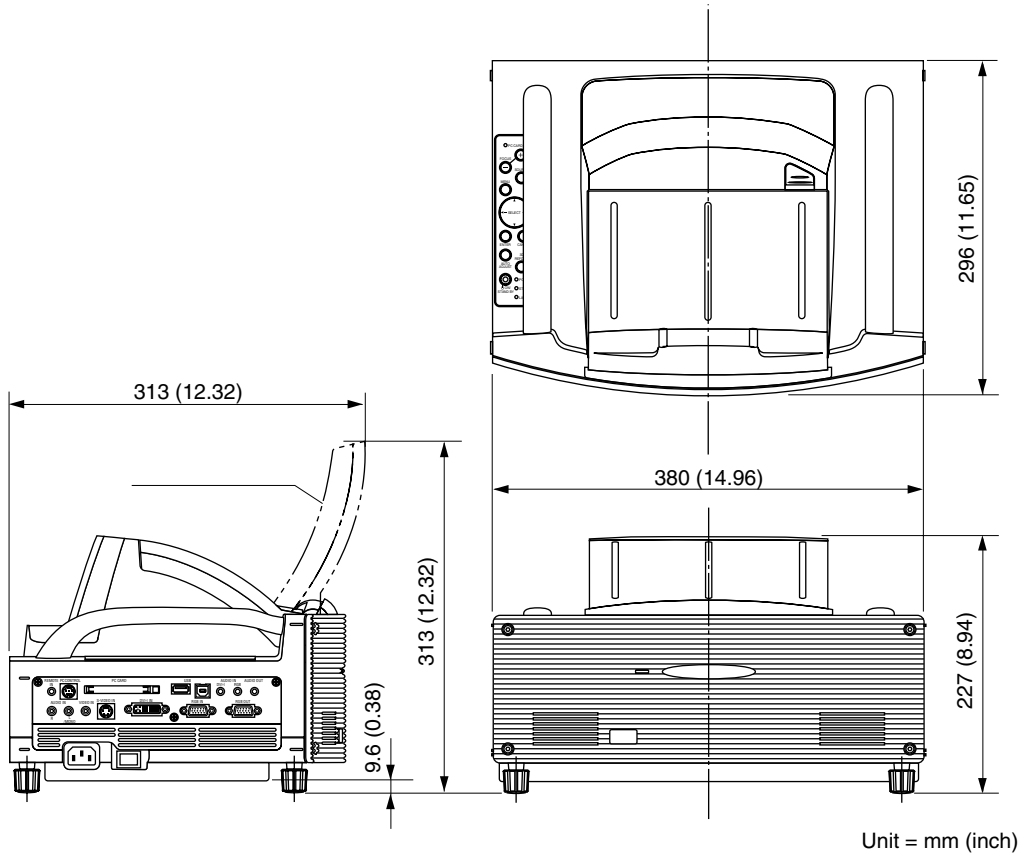

## 10-2. Pin Assignments of D-Sub RGB Input Connector

### Mini D-Sub 15 Pin Connector

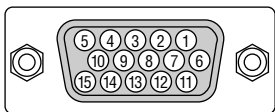

Signal Level  
 Video signal : 0.7Vp-p (Analog)  
 Sync signal : TTL level

Pin No.	RGB Signal (Analog)	YCbCr Signal
1	Red	Cr
2	Green or Sync on Green	Y
3	Blue	Cb
4	Ground	
5	Ground	
6	Red Ground	Cr Ground
7	Green Ground	Y Ground
8	Blue Ground	Cb Ground
9	No Connection	
10	Sync Signal Ground	
11	SCART Sync	
12	Bi-directional DATA (SDA)*	
13	Horizontal Sync or Composite Sync	
14	Vertical Sync	
15	Data Clock	

\* Supports RGB input (RGB IN) only.

### 10-3. Compatible Input Signal List

Signal	Resolution ( Dots )	Frequency H. ( kHz )	Refresh Rate ( Hz )	Dot Clock ( MHz )
NTSC	–	15.734	60	–
PAL	–	15.625	50	–
PAL60	–	15.734	60	–
SECAM	–	15.625	50	–
D VESA	640 × 480	31.47	59.94	25.175
IBM	640 × 480	31.47	60	25.175
MAC	640 × 480	31.47	60	25.175
MAC	640 × 480	34.97	66.67	31.334
MAC	640 × 480	35	66.67	30.24
D VESA	640 × 480	37.86	72.81	31.5
D VESA	640 × 480	37.5	75	31.5
IBM	640 × 480	39.375	75	31.49
D VESA	640 × 480	43.269	85.01	36
IBM	720 × 350	31.469	70.09	28.322
D VESA	720 × 400	37.927	85.04	35.5
IBM	720 × 350	39.44	87.85	35.5
IBM	720 × 400	39.44	87.85	35.5
D VESA	800 × 600	35.16	56.25	36
D VESA	800 × 600	37.879	60.32	40
D VESA	800 × 600	48.077	72.19	50
D VESA	800 × 600	46.88	75	49.5
D VESA	800 × 600	53.674	85.06	56.25
MAC	832 × 624	49.725	74.55	57.283
VESA	1024 × 768	35.5	43 Interlaced	44.9
D VESA	1024 × 768	48.363	60	65
D VESA	1024 × 768	56.476	70.07	75
MAC	1024 × 768	60.241	74.93	80
D VESA	1024 × 768	60.023	75.03	78.75
D VESA	1024 × 768	68.677	85	94.5
# D VESA	1152 × 864	67.5	75	108
# MAC	1152 × 870	68.681	75.06	100
# SUN	1152 × 900	61.796	65.95	92.94
# SGI	1152 × 900	71.736	76.05	105.6
# D VESA	1280 × 960	60	60	108
# D VESA	1280 × 1024	63.981	60.02	108
# MAC	1280 × 1024	69.89	65.2	118.5
# HP	1280 × 1024	78.125	72.01	135
# SUN	1280 × 1024	81.13	76.11	135
# VESA	1280 × 1024	79.976	75.03	135
# VESA	1280 × 1024	91.146	85.02	157.5
# HDTV (1080i)(1125i)	1920 × 1080	33.75	60 Interlace	74.25
# HDTV (1080i)(1125i)	1920 × 1080	28.13	50 Interlace	74.25
# HDTV (720p)(750p)	1280 × 720	45	60 Progressive	74.25
# SDTV (480p)(525p)	–	31.47	59.94 Progressive	27
# VESA	1600 × 1200	75.0	60	162
# VESA	1600 × 1200	81.3	65	175.5
# VESA	1600 × 1200	87.5	70	189
# VESA	1600 × 1200	93.75	75	202.5
DVD YCbCr	–	15.734	59.94 Interlaced	–
DVD YCbCr	–	15.625	50 Interlaced	–

#: Images above flagged with # are compressed with Advanced AccuBlend.

D: Images above flagged with “D” are supported by digital signal.

*NOTE: Some composite sync signals may not be displayed correctly.*

*Signals other than those specified in the table above may not be displayed correctly. If this should happen, change the refresh rate or resolution on your PC. Refer to Display Properties help section of your PC for procedures.*

*UXGA (1600×1200) is supported for separate sync signal only.*

## 10-4. PC Control Codes and Cable Connection

### PC Control Codes

Function	Code Data							
POWER ON	02H	00H	00H	00H	00H	02H		
POWER OFF	02H	01H	00H	00H	00H	03H		
INPUT SELECT RGB	02H	03H	00H	00H	02H	01H	09H	
INPUT SELECT DVI (ANALOG)	02H	03H	00H	00H	02H	01H	02H	0AH
INPUT SELECT DVI (DIGITAL)	02H	03H	00H	00H	02H	01H	1AH	22H
INPUT SELECT VIDEO	02H	03H	00H	00H	02H	01H	06H	0EH
INPUT SELECT S-VIDEO	02H	03H	00H	00H	02H	01H	0BH	13H
INPUT SELECT VIEWER	02H	03H	00H	00H	02H	01H	1FH	27H
PICTURE MUTE ON	02H	10H	00H	00H	00H	12H		
PICTURE MUTE OFF	02H	11H	00H	00H	00H	13H		
SOUND MUTE ON	02H	12H	00H	00H	00H	14H		
SOUND MUTE OFF	02H	13H	00H	00H	00H	15H		
ON SCREEN MUTE ON	02H	14H	00H	00H	00H	16H		
ON SCREEN MUTE OFF	02H	15H	00H	00H	00H	17H		

*NOTE: Contact your local dealer for a full list of PC Control Codes if needed.*

### Cable Connection

#### Communication Protocol

Baud rate : 38400 bps  
 Data length : 8 bits  
 Parity : No parity  
 Stop bit : One bit  
 X on/off : None  
 Communications procedure : Full duplex

*NOTE: Depending on the equipment, a lower baud rate may be recommended for long cable runs.*

### PC Control Connector (DIN-8P)

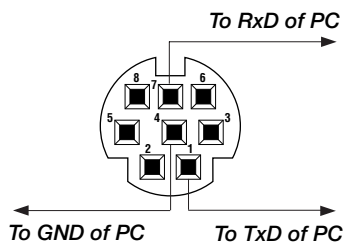

*NOTE: Pins 2, 3, 5, 6 and 8 are used inside the projector.*

## 10-5. Using Software Keyboard

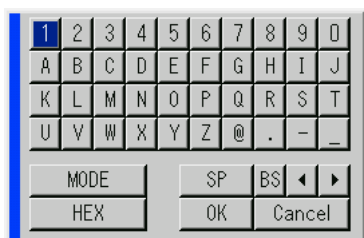

- 1 to 0 and Characters ..... Use to type in IP address or projector name
- SP ..... Inserts a space
- BS ..... Deletes one character backward
- ◀ ..... Returns to the previous
- ▶ ..... Advances to the next
- OK ..... Executes the selection
- Cancel ..... Cancels the selection
- Drag bar ..... Use to move the software keyboard on the screen.
- MODE ..... Selects one of three modes for alphabet and special characters.
- HEX/ASCII ..... Toggles between "HEX" and "ASCII".

## 10-6. Operation Using an HTTP Brouter

### Overview

The use of HTTP server functions will allow control of the projector from a web browser without the installation of special software. Please be sure to use "Microsoft Internet Explorer 4.x" or a higher version for the web browser. (This device uses "JavaScript" and "Cookies" and the browser should be set to accept these functions. The setting method will vary depending on the version of browser. Please refer to the help files and the other information provided in your software.)

**NOTE:**

- \* The use of HTTP server functions is not available during Standby mode.
- \* The display's or button's response can be slowed down or operation may not be accepted depending the settings of your network. Should this happen, consult your network administrator.
- \* The projector may not respond if its buttons are repeatedly pressed in rapid intervals. Should this happen, wait a moment and repeat. If you still can't get any response, pull out and then re-insert the LAN card.

Access is gained to the HTTP server functions by specifying `http:// <the projector's IP address> /index.html` in the entry column of the URL.

**CAUTION:**

Do not use the HTTP Server functions and the Dynamic Image Utility included on the supplied CD-ROM. Using both at the same time may result in a connection failure or slow response.

**Preparation Before Use**

Make network connections and set up the projector and confirm that it is complete before engaging in browser operations. (See "Setting LAN Mode" on page 6-18.)

Operation with a browser that uses a proxy server may not be possible depending on the type of proxy server and the setting method. Although the type of proxy server will be a factor, it is possible that items that have actually been set will not be displayed depending on the effectiveness of the cache, and the contents set from the browser may not be reflected in operation. It is recommended that a proxy server not be used unless it is unavoidable.

**Handling of the Address for Operation via a Browser**

Regarding the actual address that is entered for the address or entered to the URL column when operation of the projector is via a browser, the host name can be used as it is when the host name corresponding to the IP address of the projector has been registered to the domain name server by a network administrator, or the host name corresponding to the IP address of the projector has been set in the "HOSTS" file of the computer being used.

Example 1: When the host name of the projector has been set to "pj.nec.co.jp", `http://pj.nec.co.jp/index.html` is specified for the address or the entry column of the URL.

Example 2: When the IP address of the projector is "192.168.73.1", access is gained to the HTTP server functions by specifying

`http://192.168.73.1/index.html` for the address or the entry column of the URL.

### Structure of the HTTP Server

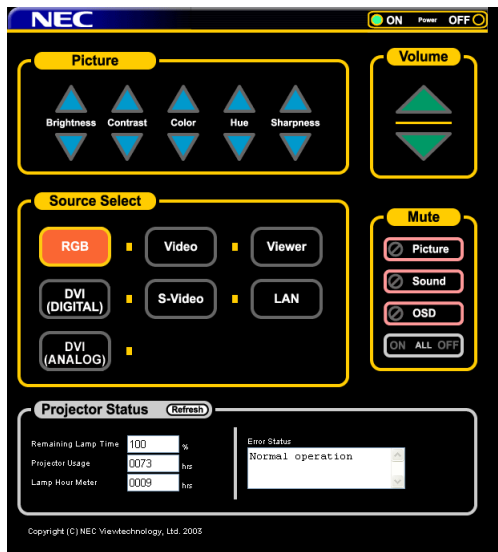

**Power:** This controls the power of the projector.

- On ..... Power is switched on.
- Off ..... Power is switched off.

**Volume:** This controls the volume of the projector.

- ▲ ..... Increments the volume adjustment value.
- ▼ ..... Decrements the volume adjustment value.

**Mute:** This controls the mute function of the projector.

- All On ..... Mutes each of the video, audio, and on-screen display functions.
- All Off ..... Cancels the muting of each of the video, audio, and on-screen display functions.
- Picture On ..... Mutes the video.
- Picture Off ..... Cancels the video muting.
- Sound On ..... Mutes the audio.
- Sound Off ..... Cancels the audio muting.
- OSD On ..... Mutes the on-screen display.
- OSD Off ..... Cancels the muting of the on-screen display.

Picture: Controls the video adjustment of the projector.

- Brightness ▲ ..... Increments the brightness adjustment value.
- Brightness ▼ ..... Decrements the brightness adjustment value.
- Contrast ▲ ..... Increments the contrast adjustment value.
- Contrast ▼ ..... Decrements the contrast adjustment value.
- Color ▲ ..... Increments the color adjustment value.
- Color ▼ ..... Decrements the color adjustment value.
- Hue ▲ ..... Increments the hue adjustment value.
- Hue ▼ ..... Decrements the hue adjustment value.
- Sharpness ▲ ..... Increments the sharpness adjustment value.
- Sharpness ▼ ..... Decrements the sharpness adjustment value.

\* The functions that can be controlled will vary depending on the signal being input to the projector.

Source Select: This switches the input connector of the projector.

- RGB ..... Switches to the RGB connector.
- DVI (ANALOG) ..... Switches to the DVI-I connector.
- DVI (DIGITAL) ..... Switches to the DVI-I connector.
- Video ..... Switches to the Video connector.
- S-Video ..... Switches to the S-Video connector.
- Viewer ..... Switches to the Viewer.
- LAN ..... Switches to a LAN signal.

Projector Status: This displays the condition of the projector.

- Remaining Lamp Time ..... Displays the remaining life of the lamp as a percentage.
- Lamp Hour Meter ..... Displays how many hours the lamp has been used.
- Projector Usage ..... Displays how many hours the projector has been used.
- Error Status ..... Displays the status of errors occurring within the projector.
- Refresh ..... Updates the display of the following conditions.