



SHARP®

XV-Z200U

PROJECTOR
PROJECTEUR
PROYECTOR
PROJETOR

OPERATION MANUAL
MODE D'EMPLOI
MANUAL DE OPERACION
MANUAL DE OPERAÇÃO

XV-Z200U

SHARP®

SHARP CORPORATION

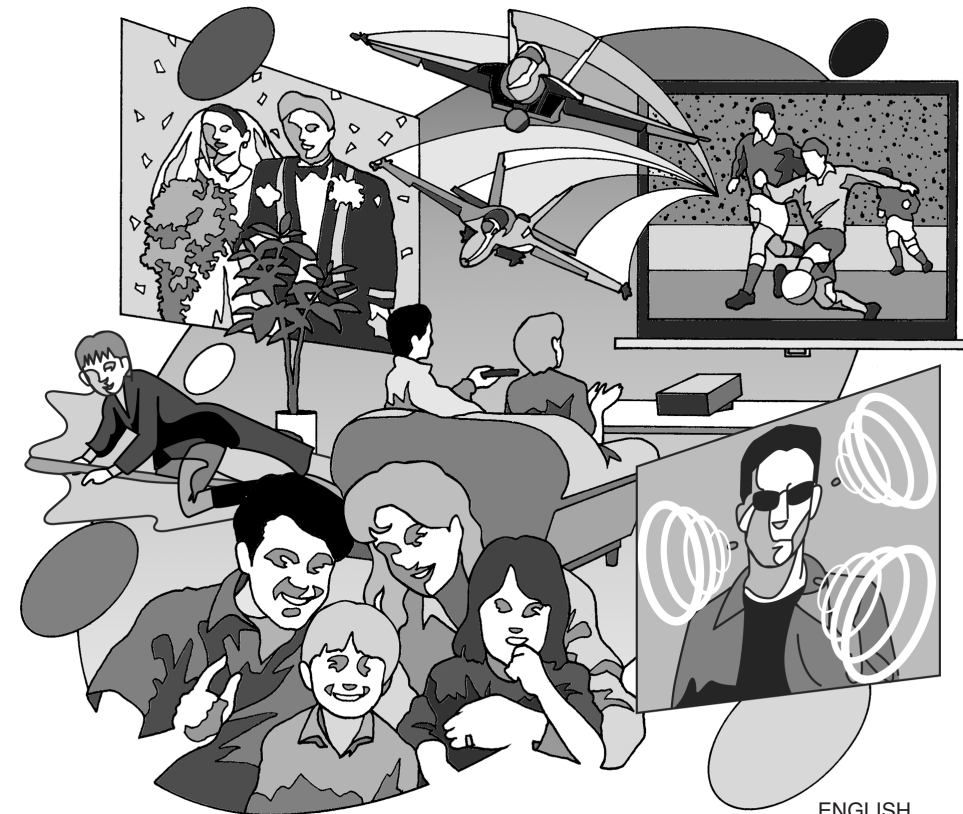

ENGLISH (E) -1 – (E) -72
FRANÇAIS (F) -1 – (F) -71
ESPAÑOL (ES) -1 – (ES) -70
PORTUGUÊS (P) -1 – (P) -70

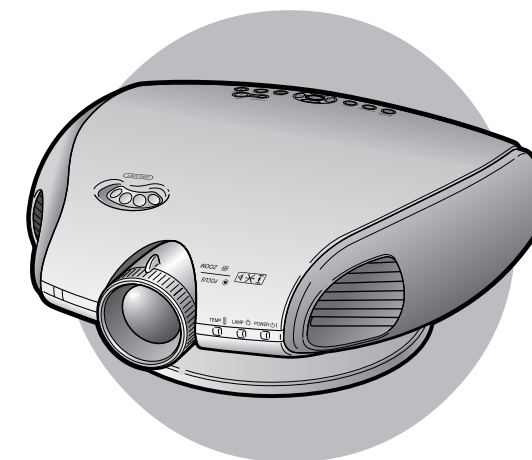

SHARP®

Printed in Japan
Imprimé au Japon
Impreso en Japón
Impresso no Japão
TINS-B005WJZZ
03P11-JWM

Printed on 100% post-consumer recycled paper.
Imprimé sur 100% de papier recyclé.
Impreso en 100% de papel reciclado de postconsumo.
Papel 100% Reciclado - Cuidado do Meio Ambiente.





Before using the projector, please read this operation manual carefully.

Introduction ENGLISH

IMPORTANT

For your assistance in reporting the loss or theft of your Projector, please record the Serial Number located on the bottom of the projector and retain this information. Before recycling the packaging, please be sure that you have checked the contents of the carton thoroughly against the list of "Supplied accessories" on page 12.

Model No.: XV-Z200U

Serial No.:

There are two important reasons for prompt warranty registration of your new SHARP Projector, using the REGISTRATION CARD packed with the projector.

1. WARRANTY

This is to assure that you immediately receive the full benefit of the parts, service and labor warranty applicable to your purchase.

2. CONSUMER PRODUCT SAFETY ACT

To ensure that you will promptly receive any safety notification of inspection, modification, or recall that SHARP may be required to give under the 1972 Consumer Product Safety Act, PLEASE READ CAREFULLY THE IMPORTANT "LIMITED WARRANTY" CLAUSE. U.S.A. ONLY

WARNING: High brightness light source. Do not stare into the beam of light, or view directly. Be especially careful that children do not stare directly into the beam of light.



WARNING: To reduce the risk of fire or electric shock, do not expose this product to rain or moisture.

See bottom of actual set.

CAUTION

**RISK OF ELECTRIC SHOCK.
DO NOT REMOVE SCREWS
EXCEPT SPECIFIED USER
SERVICE SCREWS.**



The lightning flash with arrowhead symbol, within an equilateral triangle, is intended to alert the user to the presence of uninsulated "dangerous voltage" within the product's enclosure that may be of sufficient magnitude to constitute a risk or electric shock to persons.

**CAUTION: TO REDUCE THE RISK OF ELECTRIC SHOCK,
DO NOT REMOVE COVER.
NO USER-SERVICEABLE PARTS EXCEPT LAMP UNIT.
REFER SERVICING TO QUALIFIED SERVICE
PERSONNEL.**



The exclamation point within a triangle is intended to alert the user to the presence of important operating and maintenance (servicing) instructions in the literature accompanying the product.

WARNING: FCC Regulations state that any unauthorized changes or modifications to this equipment not expressly approved by the manufacturer could void the user's authority to operate this equipment. U.S.A. ONLY

PRODUCT DISPOSAL
This product utilizes tin-lead solder, and high intensity discharge lamp (HID lamp) containing a small amount of mercury. Disposal of these materials may be regulated due to environmental considerations. For disposal or recycling information, please contact your local authorities or the Electronic Industries Alliance: www.eiae.org.



INFORMATION

This equipment has been tested and found to comply with the limits for a Class B digital device, pursuant to Part 15 of the FCC Rules. These limits are designed to provide reasonable protection against harmful interference in a residential installation. This equipment generates, uses, and can radiate radio frequency energy and, if not installed and used in accordance with the operation manual, may cause harmful interference to radio communications. However, there is no guarantee that interference will not occur in a particular installation. If this equipment does cause harmful interference to radio or television reception, which can be determined by turning the equipment off and on, the user is encouraged to try to correct the interference by one or more of the following measures:

- Reorient or relocate the receiving antenna.
- Increase the separation between the equipment and the receiver.
- Connect the equipment into an outlet on a circuit different from that to which the receiver is connected.
- Consult the dealer or an experienced radio/TV technician for help.

U.S.A. ONLY

Declaration of Conformity

SHARP PROJECTOR, MODEL XV-Z200U

This device complies with Part 15 of the FCC rules. Operation is subject to the following conditions: (1) This device may not cause harmful interference, and (2) this device must accept any interference received, including interference that may cause undesired operation.

Responsible Party:

SHARP ELECTRONICS CORPORATION
Sharp Plaza, Mahwah, New Jersey 07430
TEL: 1-800-BE-SHARP (1-800-237-4277)

U.S.A. ONLY

WARNING:

The cooling fan in this projector continues to run for about 90 seconds after the projector enters the standby mode. During normal operation, when putting the projector into the standby mode always use the STANDBY button on the projector or on the remote control. Ensure the cooling fan has stopped before disconnecting the power cord. DURING NORMAL OPERATION, NEVER TURN THE PROJECTOR OFF BY DISCONNECTING THE POWER CORD. FAILURE TO OBSERVE THIS WILL RESULT IN PREMATURE LAMP FAILURE.

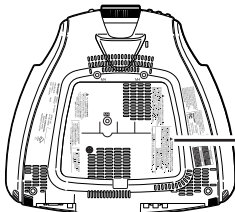

Caution Concerning the Lamp Replacement

There is potential glass particles hazard if the lamp ruptures.



LAMP REPLACEMENT CAUTION

BEFORE REMOVING THE SCREW, DISCONNECT POWER CORD. HOT SURFACE INSIDE. ALLOW 1 HOUR TO COOL BEFORE REPLACING THE LAMP. REPLACE WITH SAME SHARP LAMP UNIT TYPE B0C-XVZ200++1 ONLY. UV RADIATION: CAN CAUSE EYE DAMAGE. TURN OFF LAMP BEFORE SERVICING. HIGH PRESSURE LAMP: RISK OF EXPLOSION. POTENTIAL HAZARD OF GLASS PARTICLES IF LAMP HAS RUPTURED. HANDLE WITH CARE. SEE OPERATION MANUAL.



PRECAUTIONS A OBSERVER LORS DU REMPLACEMENT DE LA LAMPE.

DEBRANCHER LE CORDON D'ALIMENTATION AVANT DE RETIRER LES VIS. L'INTERIEUR DU BOITIER ETANT EXTREMEMENT CHAUD, ATTENDRE 1 HEURE AVANT DE PROCEDER AU REMPLACEMENT DE LA LAMPE. NE REMPLACER QUE PAR UNE LAMPE SHARP DE TYPE B0C-XVZ200++1. RAYONS ULTRAVIOLETS: PEUVENT ENDOMMAGER LES YEUX. ETEINDRE LA LAMPE AVANT DE PROCEDER A L'ENTRETIEN. LAMPE A HAUTE PRESSION: RISQUE D'EXPLOSION. DANGER POTENTIEL DE PARTICULES DE VERRE EN CAS D'ECLATEMENT DE LA LAMPE. A MANIPULER AVEC PRECAUTION, SE REPORTER AU MODE D'EMPLOI.

WARNING:

Some IC chips in this product include confidential and/or trade secret property belonging to Texas Instruments. Therefore you may not copy, modify, adapt, translate, distribute, reverse engineer, reverse assemble or discompile the contents thereof.



Contents

Introduction

Contents	3
IMPORTANT SAFEGUARDS	4
Quick Guide	7
Part Names	8
Operating the Remote Control	11
Accessories	12

Connections & Setup

Connecting the Projector to Other Devices	14
Connecting the Power Cord	14
Connecting to Video Equipment	15
Connecting to a DVD Player and DTV Decoder	17
Connecting to a Computer	21
Controlling the Projector by a Computer	23
Setup	24
Using the Swivel Stand	24
Removing the Swivel Stand	24
Attaching the Swivel Stand	25
Focusing and Zooming	25
Using the Lens Shift	25
Adjusting the Projection Distance	26
Image Projection	28

Basic Operation

Image Projection	30
Basic Procedure	30
Selecting the On-screen Display Language	31
Turning the Power off	32
Keystone Correction	33
Placement of the Projected Image	
Using the Keystone Correction	34
Freezing a Moving Image	35
Adjusting the Picture Aspect Ratio	35

Adjustments and Settings

Using the Menu Screen	38
Menu Selections (Adjustment)	38
Menu Selections (Settings)	40
Menu Bar Items	42
Adjusting the Picture	44
Adjusting Image Preferences	44
Adjusting the Color Temperature	45
Gamma Correction Function	46
Emphasizing the Contrast	46
Picture Setting Function	47
Adjusting the Computer and	
DVD/DTV Images	48
When Auto Sync is OFF	48
Special Modes Adjustment	49
Auto Sync Adjustment	50
Checking the Input Signal	50

Using the “Options” Menu	51
Checking the Lamp Life Status	51
Turning on/off the On-screen Display	51
Selecting the Signal Type	52
Setting the Video Signal (VIDEO menu only)	52
Selecting a Background Image	53
Setting the Eco Mode	53
Automatic Power Shut-off Function	54
Selecting the Menu Screen Position	54
Selecting the Menu Color	55
Reversing/Inverting Projected Images	56

Appendix

Maintenance Indicators	58
Regarding the Lamp	59
Lamp	59
Caution Concerning the Lamp	59
Replacing the Lamp	59
Removing and Installing the Lamp Unit	60
Resetting the Lamp Timer	61
Cleaning the Ventilative Holes	62
Using the Kensington Lock	63
Troubleshooting	63
For SHARP Assistance (U.S.A. only)	63
Connecting Pin Assignments	64
(RS-232C) Specifications	
and Command Settings	65
Computer Compatibility Chart	66
Specifications	67
Dimensions	68
Glossary	69
Index	70
CONSUMER LIMITED WARRANTY	
(VALID IN USA ONLY)	71
LIMITED WARRANTY	
(VALID IN CANADA ONLY)	72



IMPORTANT SAFEGUARDS

CAUTION: Please read all of these instructions before you operate this product and save them for later use.

Electrical energy can perform many useful functions. This product has been engineered and manufactured to ensure your personal safety. However IMPROPER USE CAN RESULT IN POTENTIAL ELECTRICAL SHOCK OR FIRE HAZARD. In order not to defeat the safeguards incorporated into this Projector, observe the following basic rules for its installation, use and servicing. For your own protection and reliable usage of your Projector, please be sure to read these "IMPORTANT SAFEGUARDS" carefully before use.

1. Read Instructions

All the safety and operating instructions should be read before the product is operated.

2. Retain Instructions

The safety and operating instructions should be retained for future reference.

3. Heed Warnings

All warnings on the product and in the operating instructions should be adhered to.

4. Follow Instructions

All operating and use instructions should be followed.

5. Cleaning

Unplug this product from the wall outlet before cleaning. Do not use liquid cleaners or aerosol cleaners. Use a damp cloth for cleaning.

6. Attachments

Do not use attachments not recommended by the product manufacturer as they may cause hazards.

7. Water and Moisture

Do not use this product near water—for example, near a bathtub, wash bowl, kitchen sink, or laundry tub; in a wet basement; or near a swimming pool; and the like.

8. Accessories

Do not place this product on an unstable cart, stand, tripod, bracket, or table. The product may fall, causing serious injury to a child or adult, and serious damage to the product. Use only with a cart, stand, tripod, bracket, or table recommended by the manufacturer, or sold with the product. Any mounting of the product should follow the manufacturer's instructions, and should use a mounting accessory recommended by the manufacturer.

9. Transportation

A product and cart combination should be moved with care. Quick stops, excessive force, and uneven surfaces may cause the product and cart combination to overturn.



10. Ventilation

Slots and openings in the cabinet are provided for ventilation to ensure reliable operation of the product and to protect it from overheating. The openings should never be covered or blocked by placing the product on a bed, sofa, rug, or other similar surface. This product should not be placed in a built-in installation such as a bookcase or rack unless proper ventilation is provided or the manufacturer's instructions have been adhered to.

11. Power Sources

This product should be operated only from the type of power source indicated on the marking label. If you are not sure of the type of power supply to your home, consult your product dealer or local power company. For products intended to operate from battery power, or other sources, refer to the operating instructions.

12. Grounding or Polarization

This product is equipped with a three-wire grounding-type plug, a plug having a third (grounding) pin. This plug will only fit into a grounding-type power outlet. This is a safety feature. If you are unable to insert the plug into the outlet, contact your electrician to replace your obsolete outlet. Do not defeat the safety purpose of the grounding-type plug.

13. Power-Cord Protection

Power-supply cords should be routed so that they are not likely to be walked on or pinched by items placed upon or against them, paying particular attention to cords at plugs, convenience receptacles, and the point where they exit from the product.

14. Lightning

For added protection for this product during a lightning storm, or when it is left unattended and unused for long periods of time, unplug it from the wall outlet and disconnect the power cord. This will prevent damage to the product due to lightning and power-line surges.

15. Overloading

Do not overload wall outlets, extension cords, or integral convenience receptacles as this can result in a risk of fire or electric shock.

16. Object and Liquid Entry

Never push objects of any kind into this product through openings as they may touch dangerous voltage points or short-out parts that could result in a fire or electric shock. Never spill liquid of any kind on the product.

17. Servicing

Do not attempt to service this product yourself as opening or removing covers may expose you to dangerous voltage or other hazards. Refer all servicing to qualified service personnel.



18. Damage Requiring Service

Unplug this product from the wall outlet and refer servicing to qualified service personnel under the following conditions:

- a. If the power-supply cord or plug is damaged.
- b. If liquid has been spilled, or objects have fallen into the product.
- c. If the product has been exposed to rain or water.
- d. If the product does not operate normally by following the operating instructions. Adjust only those controls that are covered by the operating instructions, as an improper adjustment of other controls may result in damage and will often require extensive work by a qualified technician to restore the product to normal operation.
- e. If the product has been dropped or damaged in any way.
- f. If the product exhibits a distinct change in performance.

19. Replacement Parts

When replacement parts are required, be sure the service technician has used replacement parts specified by the manufacturer or have the same characteristics as the original part. Unauthorized substitutions may result in fire, electric shock, or other hazards.

20. Safety Check

Upon completion of any service or repairs to this product, ask the service technician to perform safety checks to determine that the product is in proper operating condition.

21. Wall or Ceiling Mounting

This product should be mounted to a wall or ceiling only as recommended by the manufacturer.

22. Heat

This product should be situated away from heat sources such as radiators, heat registers, stoves, or other products (including amplifiers) that produce heat.

- Digital Light Processing, DLP, Digital Micromirror Device and DMD are trademarks of Texas Instruments.
- Microsoft and Windows are registered trademarks of Microsoft Corporation in the United States and/or other countries.
- PC/AT is a registered trademark of International Business Machines Corporation in the United States.
- Macintosh is a registered trademark of Apple Computer, Inc. in the United States and/or other countries.
- All other company or product names are trademarks or registered trademarks of their respective companies.



IMPORTANT SAFEGUARDS

Be sure to read the following safeguards when setting up your projector.

Caution concerning the lamp unit

- There is a potential hazard of glass particles if the lamp ruptures. In case of lamp rupture, contact your nearest Authorized SharpVision Service Center or Dealer for replacement. See "Replacing the Lamp" on page 59.

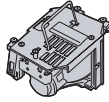

Cautions concerning the setup of the projector

- For minimal servicing and to maintain high image quality, SHARP recommends that this projector be installed in an area free from humidity, dust and cigarette smoke. When the projector is subjected to these environments, the lens and part of filter must be cleaned more often than usual. As long as the projector is properly maintained in this manner, use in these environments will not reduce the overall operation life. Please note that all internal cleaning must be performed by an Authorized SharpVision Service Center or Dealer.

Do not set up the projector in places exposed to direct sunlight or bright light.

- Position the screen so that it is not in direct sunlight or room light. Light falling directly on the screen washes out the colors, making viewing difficult. Close the curtains and dim the lights when setting up the screen in a sunny or bright room.

Do not subject the projector to hard impact and/or vibration.

- Take care with the lens so as not to hit or damage the surface of the lens.

Rest your eyes occasionally.

- Watching the screen for long hours continuously will make your eyes tired. Be sure to occasionally rest your eyes.

Do not expose the projector to extreme heat or cold.

- Operating temperature: 41°F to 95°F (+5°C to 35°C)
- Storage temperature: -4°F to 140°F (-20°C to +60°C)

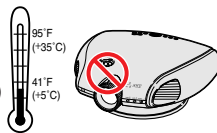

Notes on Operation

- The exhaust ventilative holes, the lamp unit cover and adjacent areas may get extremely hot during projector operation. To prevent injury, do not touch these areas until they have sufficiently cooled down.
- Allow at least 1 foot (30 cm) of space between the exhaust ventilative hole and the nearest wall or obstruction.



- If the cooling fan becomes obstructed, a protection device will automatically turn off the projector lamp. This does not indicate a malfunction. Remove the projector power cord from the wall outlet and wait at least 10 minutes. Then turn on the power by plugging the power cord back in. This will return the projector to the normal operating condition.

Cautions regarding the transportation of the projector

- When transporting the projector, be sure not to subject it to hard impact and/or vibration, as this can result in damage. Take extra caution with the lens. Before moving the projector, be sure to unplug the power cord from the wall outlet, and disconnect any other cables connected to it.

Other connected equipment

- When connecting other audio-visual equipment or a computer to the projector, make the connections AFTER turning off the projector and the equipment to be connected.
- Please read the operation manuals of the projector and the equipment to be connected for instructions on how to make the connections.

Temperature monitor function

- If the projector starts to overheat due to setup problems or blockage of the air vents, "TEMP." and "TEMP." will blink in the lower left corner of the picture. If the temperature continues to rise, the lamp will turn off, the temperature warning indicator on the projector will blink, and after a 90-second cooling-off period the projector will enter the standby mode. Refer to "Maintenance Indicators" on page 58 for details.



Info

- The cooling fan regulates the internal temperature, and its performance is automatically controlled. The sound of the fan may change during projector operation due to changes in the fan speed. This does not indicate malfunction.



Quick Guide

In this page, connection of the projector and the video equipment is explained as an example for the procedure from setup to projection. Refer to each page for details.

Required equipments

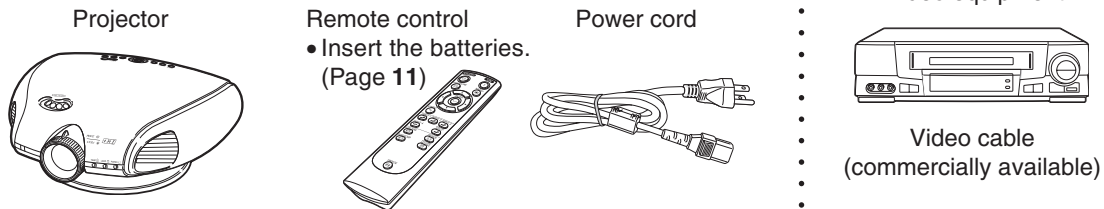

1. Place the projector facing a wall or a screen.
2. Connect to video equipment. (Page 16)

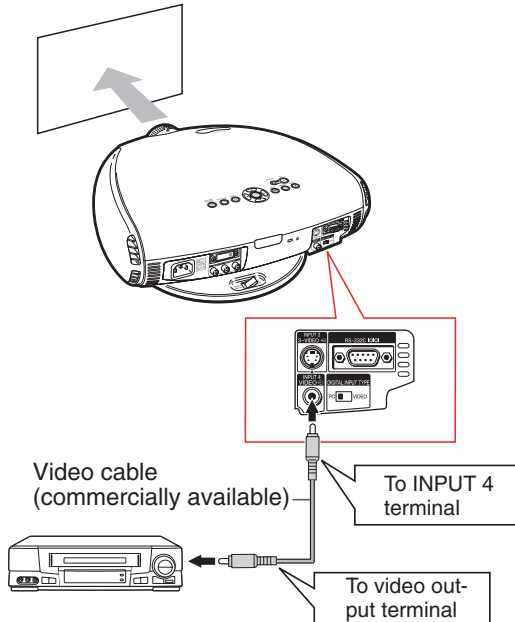

3. Connect the output terminal of the video equipment to the input terminal of the audio equipment using an audio cable.
4. Plug the power cord into the AC socket of the projector and into the wall outlet. (Page 14)
5. Remove the lens cap from the lens.

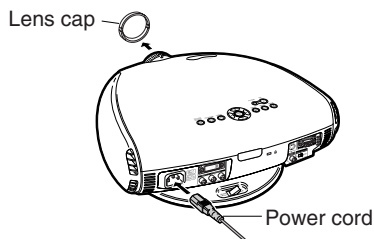

6. Turn the projector on using **ON** on the remote control. (Page 30)

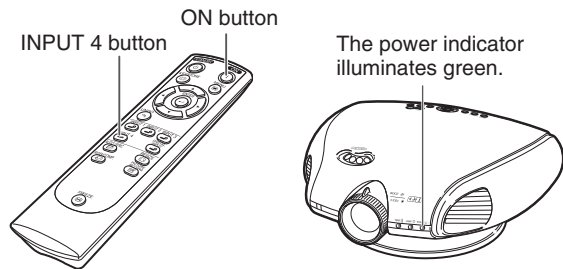

7. Press **INPUT 4** on the remote control to select the INPUT 4 mode. (Page 31)

▼ On-screen Display



8. Turn on the video equipment.

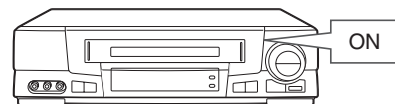

9. Play the video.
10. Adjust the image size, image position and the focus. (Page 25)

Adjust the zooming by moving the zoom knob. Adjust the height of the image by rotating the lens shift dial.

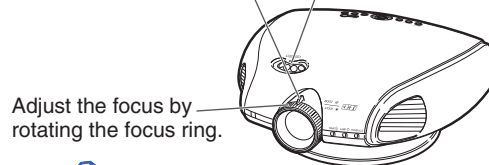

Note

- This projector can also be connected to a computer as well as to video equipment. (Page 21)



Part Names

Numbers in **■** refer to the main pages in this operation manual where the topic is explained.

Projector (Front and Top View)

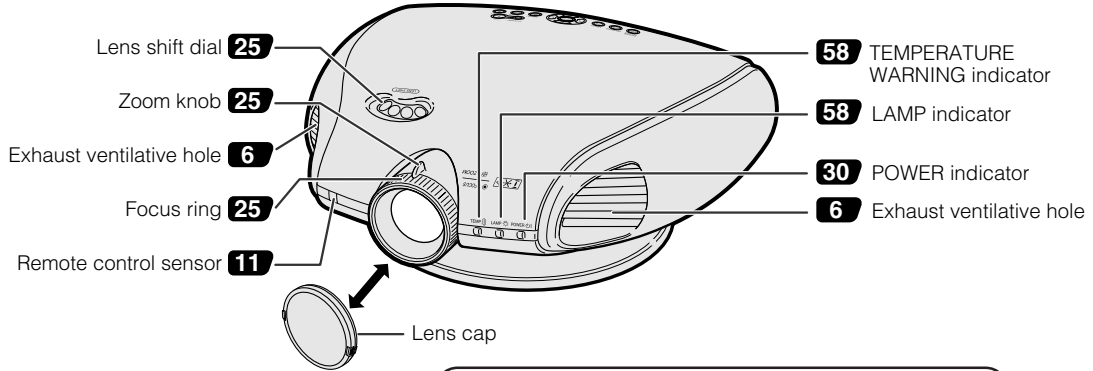

Attaching the Lens Cap
 The lens cap can be attached to the projector using commercially available straps (for cellular phones etc.), as shown in the figure.

Projector (Side and Rear View)

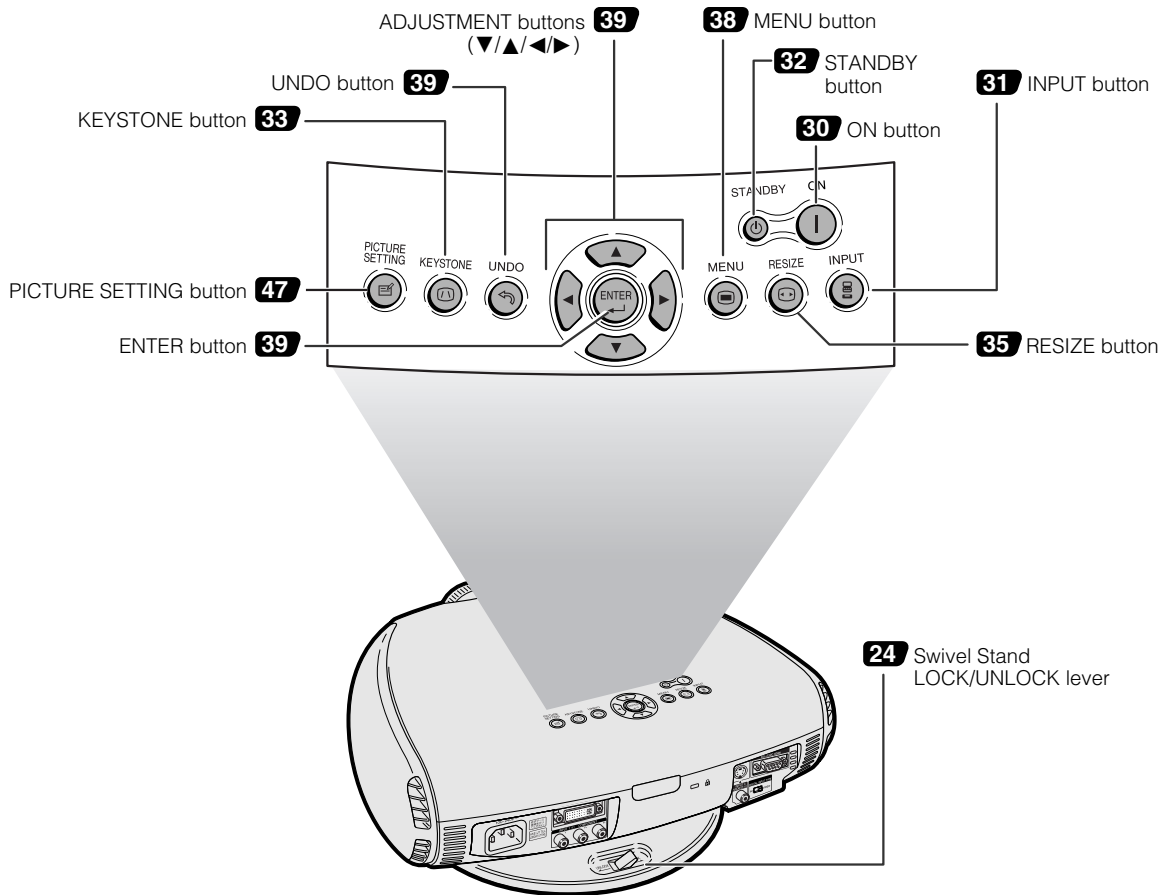



Projector (Rear View)

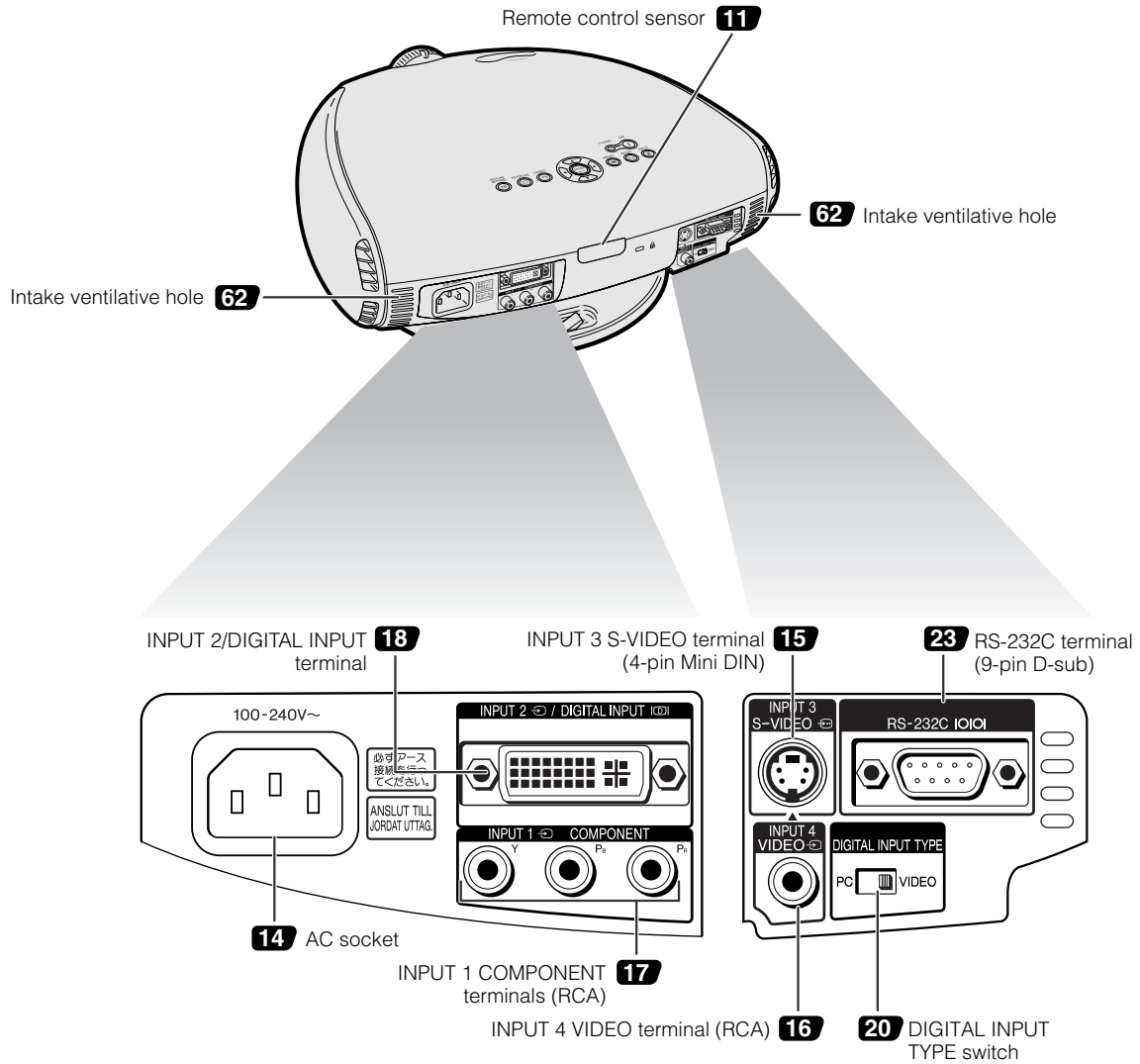

Using the Terminal Cover

When the projector is used on a desktop, high mounted or ceiling mounted, attach the terminal cover (supplied) to hide the connecting cables.

Attaching the Terminal Cover

- ① Align with the tabs on the projector and then press the terminal cover in the direction of the arrow.
- ② Tighten the two screws on the bottom of the projector.

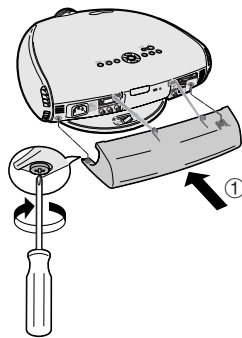

Removing the Terminal Cover

- ① Loosen the two screws on the bottom of the projector.
- ② Raise the terminal cover and pull it out in the direction of the arrow.

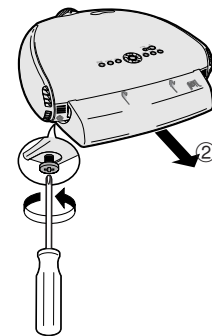



Part Names

Remote Control (Front View)

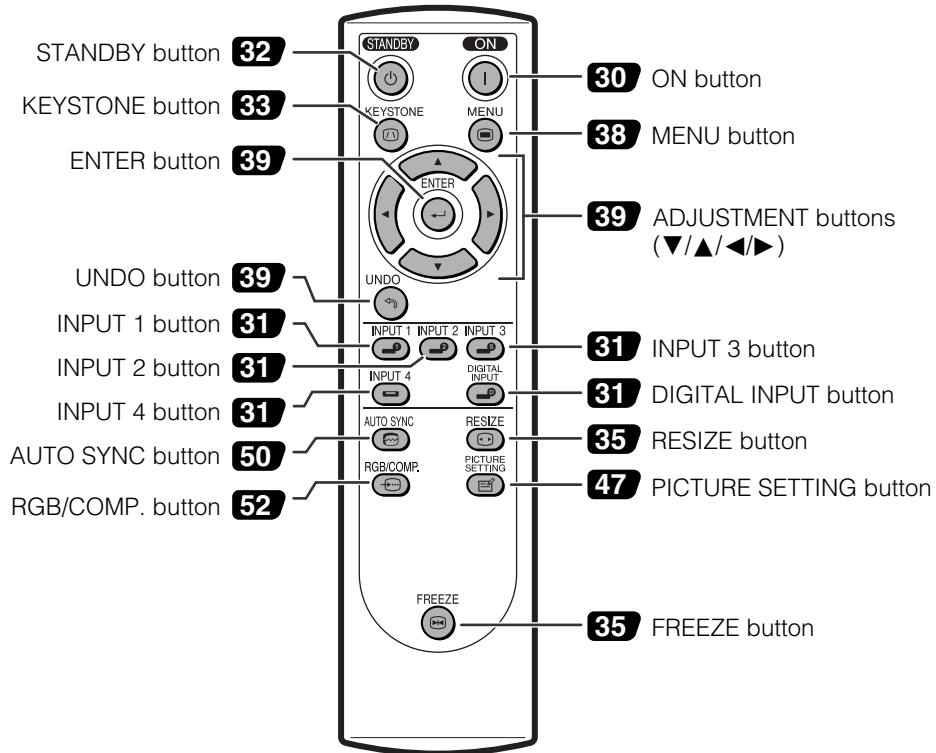

Remote Control (Top View)

Remote control signal transmitters

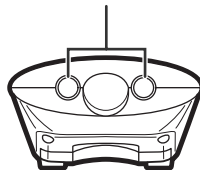



Operating the Remote Control

Available Range of the Remote Control

- The remote control can be used to control the projector within the ranges shown in the illustration.

Note

- The signal from the remote control can be reflected off a screen for easy operation. However, the effective distance of the signal may differ due to the screen material.

When using the remote control:

- Be sure not to drop, or expose to moisture or high temperature.
- The remote control may malfunction under a fluorescent lamp. Under that circumstance, move the projector away from the fluorescent lamp.

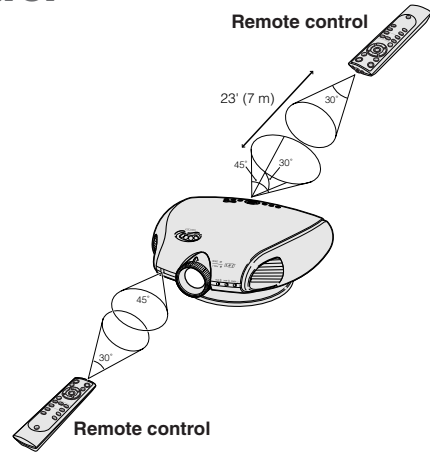

Inserting the Batteries

The batteries (two “AA” size) are included in the package.

- 1 Pull down the tab on the cover and remove the cover toward the direction of the arrow.**
- 2 Insert the included batteries.**
 - Insert the batteries making sure the polarities correctly match the \oplus and \ominus marks inside the battery compartment.
- 3 Insert the lower tab of the cover into the opening, and lower the cover until it clicks in place.**

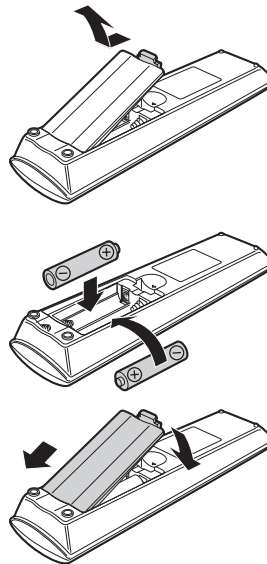

Incorrect use of the batteries may cause them to leak or explode. Please follow the precautions below.

⚠ Caution

- Insert the batteries making sure the polarities correctly match the \oplus and \ominus marks inside the battery compartment.
- Batteries of different types have different properties, therefore do not mix batteries of different types.
- Do not mix new and old batteries.
This may shorten the life of new batteries or may cause old batteries to leak.
- Remove the batteries from the remote control once they have run out, as leaving them can cause them to leak. Battery fluid from leaked batteries is harmful to your skin, therefore be sure to first wipe them and then remove them using a cloth.

- The batteries included with this projector may exhaust over a short period, depending on how they are kept. Be sure to replace them as soon as possible with new batteries when they have run out.
- Remove the batteries from the remote control if you will not be using the remote control for a long time.

Accessories

Supplied accessories

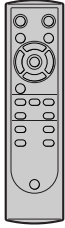

Remote control
RRMCGA218WJSA



Two AA size batteries

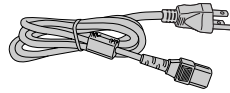

Power cord
QACCDAA007WJPZ

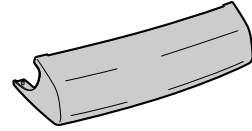

Terminal cover
GCOVAA116WJKB



Lens cap
CCAPHA004WJ01

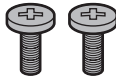

Screws for terminal cover
XBBSN40P10000

Operation manual
TINS-B005WJZZ

Optional accessories

3 RCA to 15-pin D-sub cable (9'10" (3.0 m))	AN-C3CP
DVI to 15-pin D-sub adaptor (7.9" (20 cm))	AN-A1DV
DVI cable (9'10" (3.0 m))	AN-C3DV

Note

- Some of the cables may not be available depending on the region. Please check with your nearest Authorized SharpVision Service Center or Dealer.



Connections and Setup

Connections and Setup

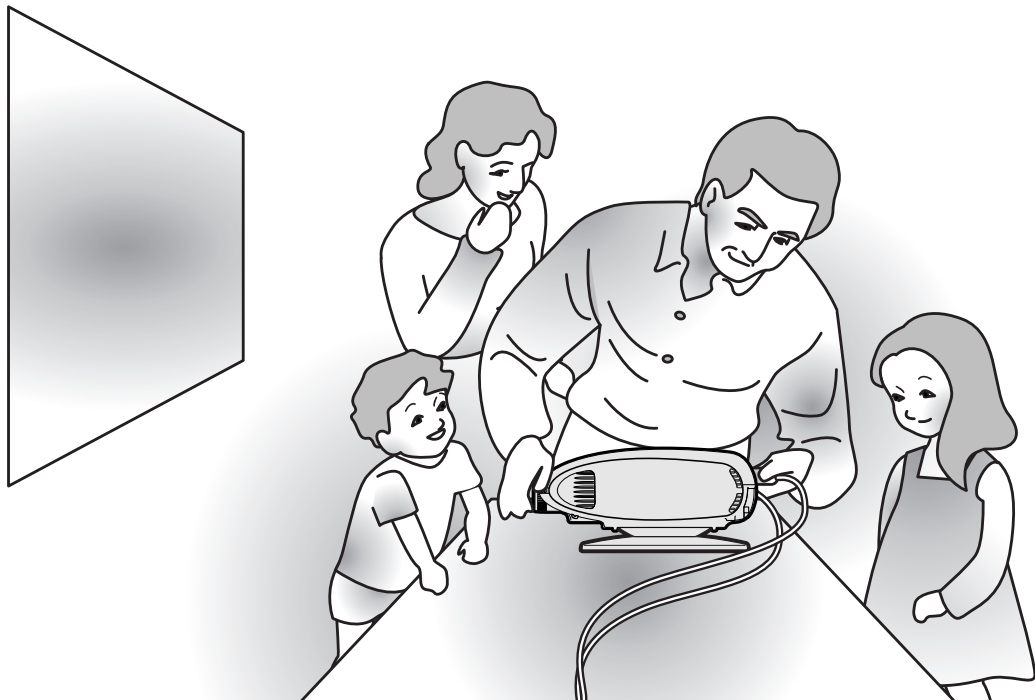



Connecting the Projector to Other Devices

Before Connecting



- Before connecting, be sure to unplug the power cord of the projector from the AC outlet and turn off the devices to be connected. After making all connections, turn on the projector and then the other devices.

When connecting a computer, be sure that it is the last device to be turned on after all the connections are made.

- Be sure to read the operation manuals of the devices to be connected before making connections.

This projector can be connected to:

Video equipment:

- A VCR, DVD player or other video equipment (See page 15.)
- A DVD player or DTV* decoder (See page 17.)

*DTV is the umbrella term used to describe the new digital television system in the United States.

A computer using:

- DVI to 15-Pin D-sub adapter (See page 21.)
- A DVI cable (See page 22.)
- An RS-232C cable (See page 23.)

Connecting the Power Cord

Plug in the supplied power cord into the AC socket on the rear of the projector.

Supplied accessory

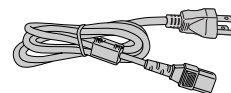

Power cord

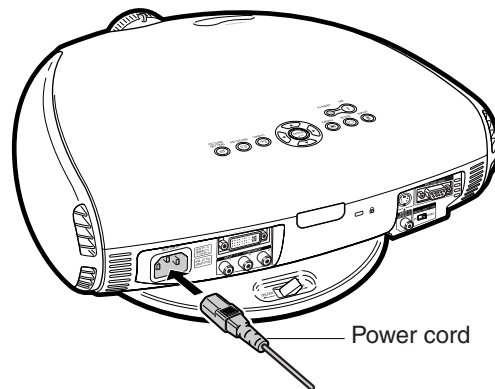

Power cord



Connecting to Video Equipment

Connecting to Video Equipment Using an S-video Cable (INPUT 3)

Using an S-video cable, a VCR, DVD player or other video equipment can be connected to INPUT 3 input terminal.

- 1** Connect an S-video cable to the projector.
- 2** Connect the S-video cable to the video equipment.

Note

- The INPUT 3 (S-VIDEO) terminal uses a video signal system in which the picture is separated into color and luminance signals to realize a higher-quality image. To view a higher-quality image, use a commercially available S-video cable to connect the INPUT 3 terminal on the projector and the S-video output terminal on the video equipment.

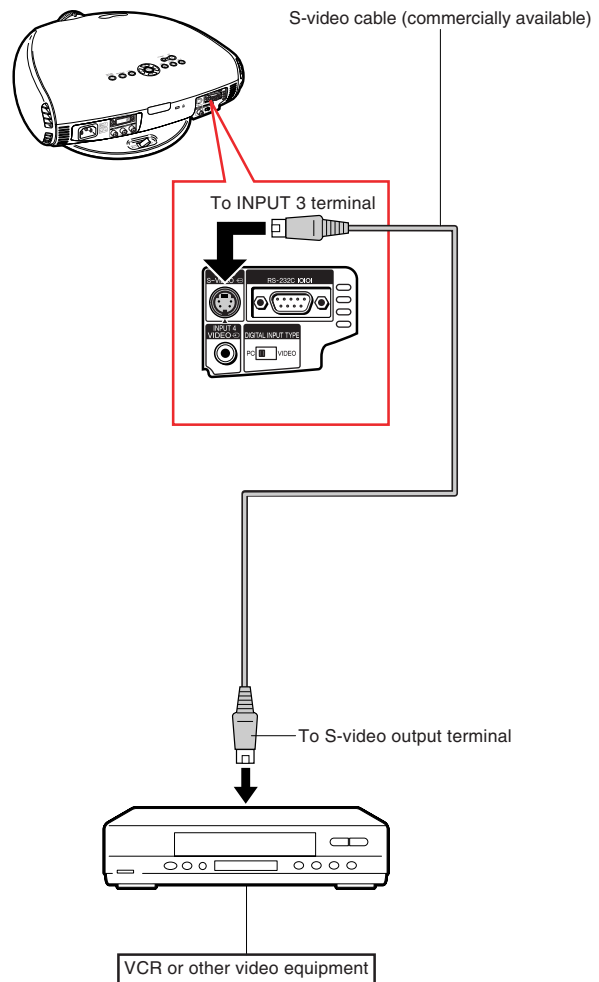

Connecting the Projector to Other Devices

Connecting to Video Equipment Using a Composite Video Cable (INPUT 4)

Using a composite video cable, a VCR, DVD player or other video equipment can be connected to INPUT 4 input terminal.

- 1** Connect a composite video cable to the projector.
- 2** Connect the composite video cable to the video equipment.

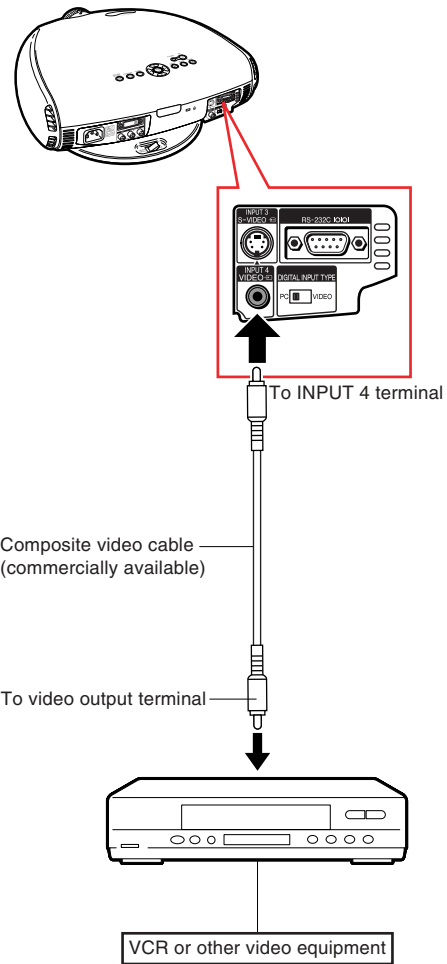



Connecting to a DVD Player and DTV Decoder

Connecting to Component Video Equipment Using a Component Cable (INPUT 1)

Use a component cable when connecting component video equipment such as DVD players and DTV decoders to INPUT 1 terminals.

- 1** Connect a component cable to the projector.
- 2** Connect the above cable to the component video equipment.

Note

- Make sure to turn both the projector and the video equipment off before connecting.

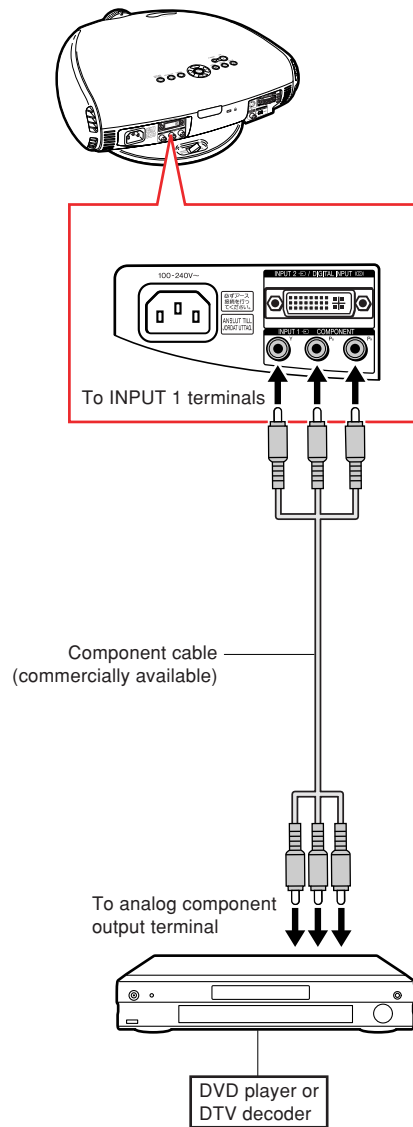



Connecting the Projector to Other Devices

Connecting to Component Video Equipment Using a 3 RCA to 15-pin D-sub Cable and the DVI to 15-pin D-sub Adaptor (INPUT 2)

Use a 3 RCA to 15-pin D-sub cable and the DVI to 15-pin D-sub adaptor when connecting component video equipment such as DVD players and DTV decoders to INPUT 2 terminal.

1 Connect a DVI to 15-pin D-sub adaptor to the projector.

2 Connect a 3 RCA to 15-pin D-sub cable to the above adaptor.

• Secure the connectors by tightening the thumbscrews.

3 Connect the above cable to the video equipment.

Note

- When connecting this projector to component output terminal of the DTV decoder, select "Component" for "Signal Type" on the OSD menu or press  on the remote control. (See page 52.)
- Make sure to turn both the projector and the video equipment off before connecting.

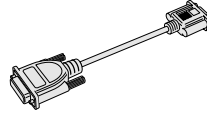
Optional accessories		3 RCA to 15-pin D-sub cable Type: AN-C3CP (9'10" (3.0 m))
		DVI to 15-pin D-sub adaptor Type: AN-A1DV (7.9" (20 cm))

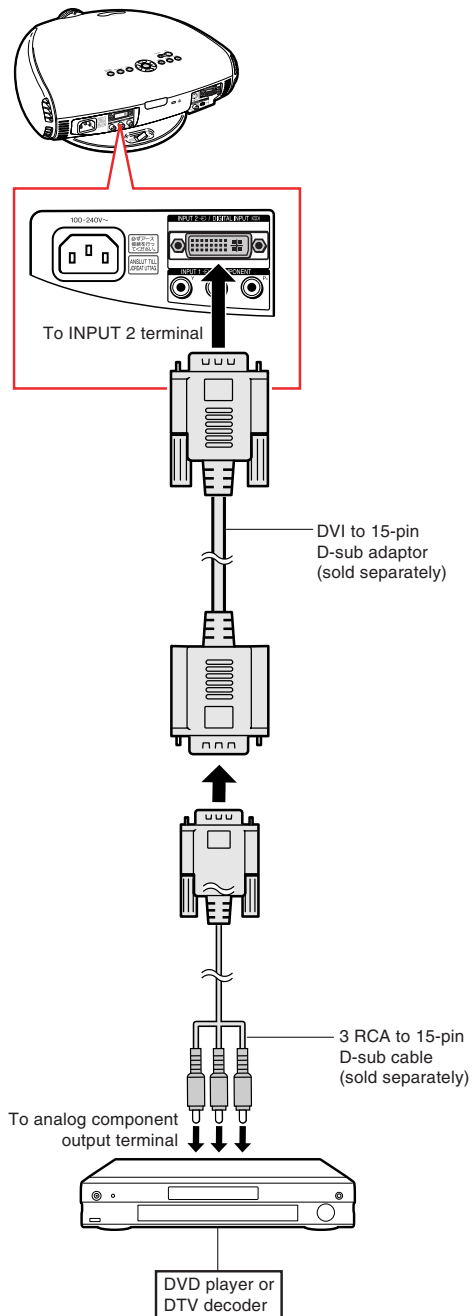



Connecting to RGB Video Equipment Using the DVI to 15-pin D-sub Adaptor and the RGB Cable (INPUT 2)

Use the DVI to 15-pin D-sub adaptor and the RGB cable when connecting RGB video equipment such as DVD players and DTV decoders to INPUT 2 terminal.

- 1** Connect a DVI to 15-pin D-sub adaptor to the projector.
- 2** Connect the above adaptor to an RGB cable.
- 3** Connect the above cable to the video equipment.

- Secure the connectors by tightening the thumbscrews.

Note

- When connecting this projector to DVI output of the DTV decoder, select "RGB" for "Signal Type" on the OSD menu or press  on the remote control. (See page 52.)

Optional accessory

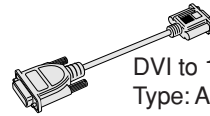

DVI to 15-pin D-sub adaptor
Type: AN-A1DV (7.9" (20 cm))

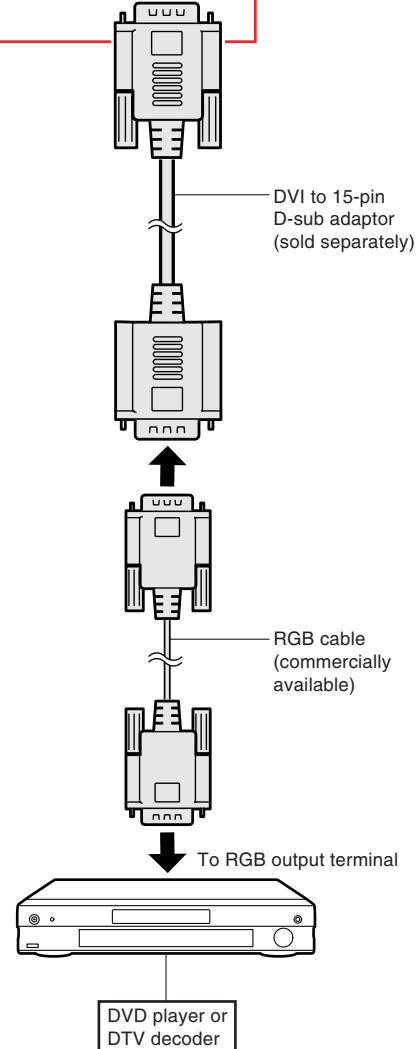
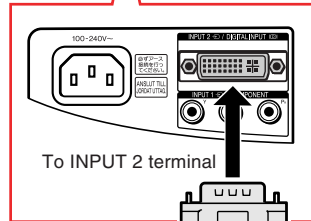
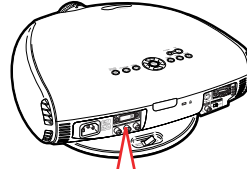

Connecting the Projector to Other Devices

Connecting to Video Equipment with the DVI Output Terminal Using a DVI Cable (DIGITAL INPUT)

Use the DVI cable when connecting video equipment with the DVI output terminal such as DVD players and DTV decoders to DIGITAL INPUT terminal.

- 1** Slide the “DIGITAL INPUT TYPE” switch on the back terminal board to “VIDEO”.
- 2** Connect the DVI cable to the DIGITAL INPUT terminal.
- 3** Connect the other end to the corresponding terminal on the DVD player or DTV decoder.

- Secure the connectors by tightening the thumbscrews.

Note

- Select DIGITAL INPUT mode when connecting to video equipment with the digital output terminal. (See page 31.)
- Make sure to turn both the projector and the video equipment off before switching the “DIGITAL INPUT TYPE” switch and connecting.

Optional accessory

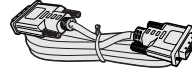

DVI cable
Type: AN-C3DV
(9'10" (3.0 m))

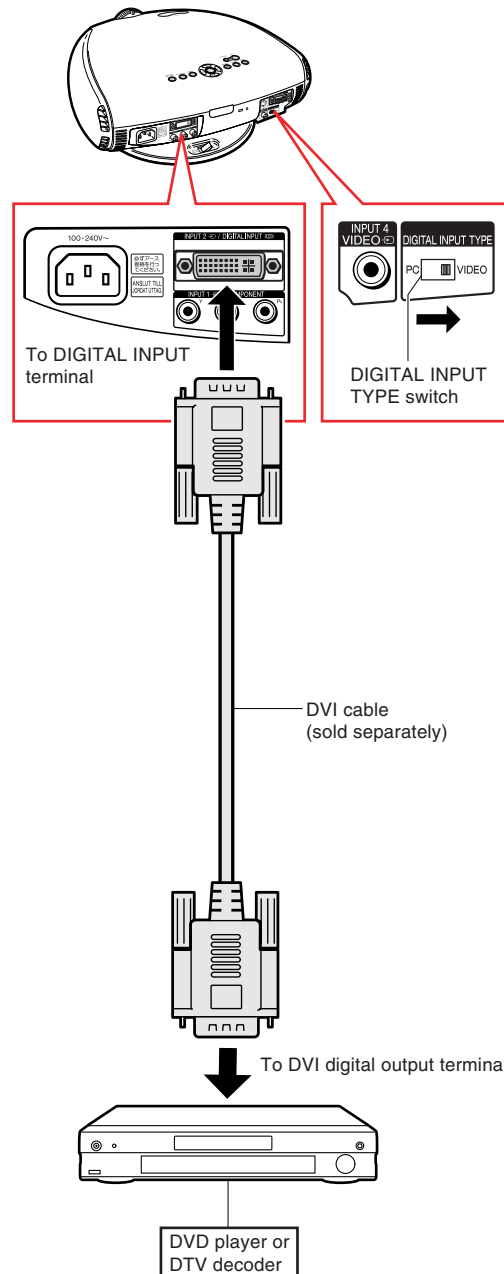



Connecting to a Computer

Connecting to a Computer Using the DVI to 15-pin D-sub Adaptor and the RGB Cable (INPUT 2)

- 1** Connect a DVI to 15-pin D-sub adaptor to the projector.
- 2** Connect the above adaptor to an RGB cable.
- 3** Connect the above cable to the computer.

- Secure the connectors by tightening the thumbscrews.

Note

- Refer to "Computer Compatibility Chart" on page 66 for a list of computer signals compatible with the projector. Use with computer signals other than those listed may cause some of the functions not to work.
- When connecting the projector to a computer in this way, select "RGB" for "Signal Type" on the OSD menu or press  on the remote control. (See page 52.)
- A Macintosh adaptor may be required for use with some Macintosh computers. Contact your nearest Authorized SharpVision Service Center or Dealer.
- Depending on the computer you are using, an image may not be projected unless the signal output setting of the computer is switched to the external output. Refer to the computer operation manual for switching the computer signal output settings.

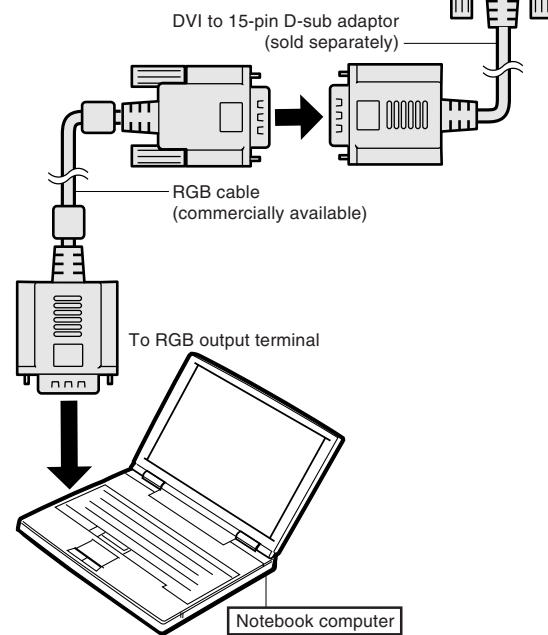
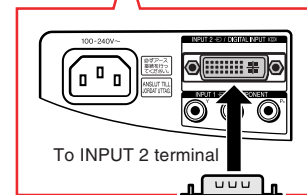
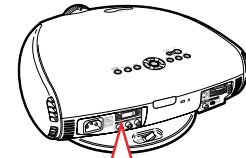
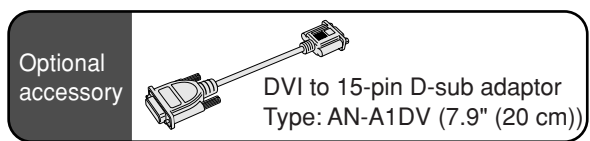

Connecting the thumbscrew cables

- Connect the thumbscrew cable making sure that it fits correctly into the terminal. Then, firmly secure the connectors by tightening the screws on both sides of the plug.
- Do not remove the ferrite core attached to the RGB cable.

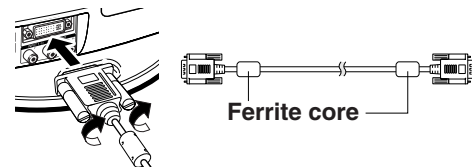

Connecting the Projector to Other Devices

Connecting to a computer with DIGITAL RGB output Terminal (DIGITAL INPUT)

- 1 Slide the “DIGITAL INPUT TYPE” switch on the back terminal board to “PC”.
- 2 Connect a DVI cable to the projector.
- 3 Connect the above cable to the computer.

- Secure the connectors by tightening the thumbscrews.

Note

- Select DIGITAL INPUT mode when connecting to digital output terminal of the computer. (See page 31.)
- Before switching the “DIGITAL INPUT TYPE” switch and connecting, be sure to unplug the power cord of the projector from the AC outlet and turn off the computer to be connected. After making all connections, turn on the projector and then the computer.
- Be sure that the computer is the last device to be turned on after all the connections are made.

Optional accessory

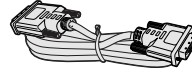

DVI cable
Type: AN-C3DV
(9'10" (3.0 m))

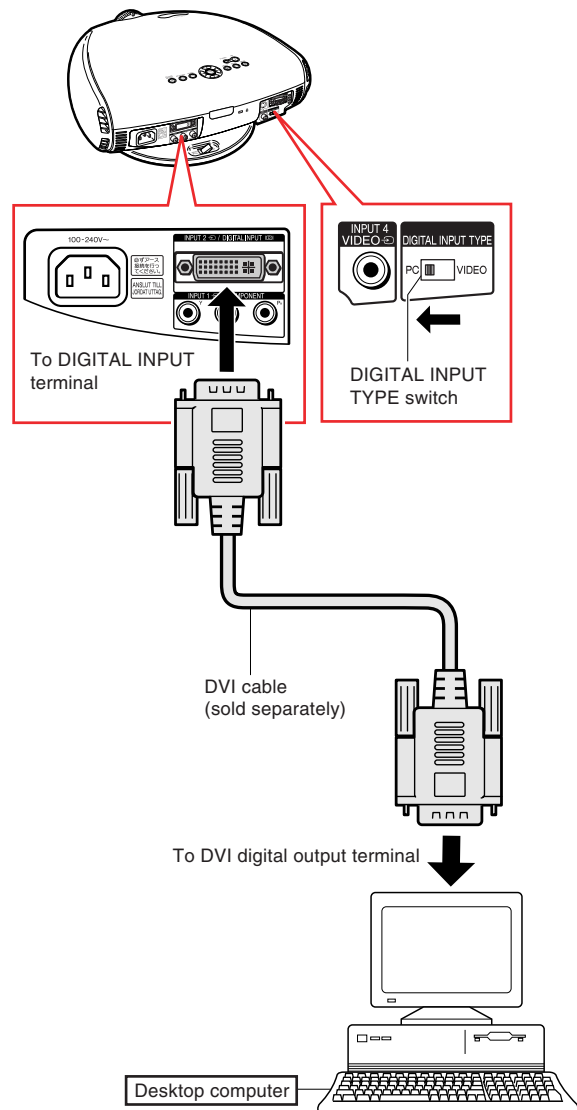

“Plug and Play” function

- This projector is compatible with VESA-standard DDC 1/DDC 2B. The projector and a VESA DDC compatible computer will communicate their setting requirements, allowing for quick and easy setup.
- **Before using the “Plug and Play” function, be sure to turn on the projector first and the connected computer last.**

Note

- The DDC “Plug and Play” function of this projector operates only when used in conjunction with a VESA DDC compatible computer.

Controlling the Projector by a Computer

Controlling the Projector Using an RS-232C Cable

When the RS-232C terminal on the projector is connected to a computer with an RS-232C cable (null modem, cross type, commercially available), the computer can be used to control the projector and check the status of the projector. See page 65 for details.

- 1** Connect an RS-232C cable to the projector.
- 2** Connect the above cable to the computer.

Note

- Do not connect or disconnect an RS-232C cable to or from the computer while it is on. This may damage your computer.
- The RS-232C function may not operate if your computer terminal is not correctly set up. Refer to the operation manual of the computer for details.
- Refer to "Computer Compatibility Chart" on page 66 for a list of computer signals compatible with the projector. Use with computer signals other than those listed may cause some of the functions not to work.

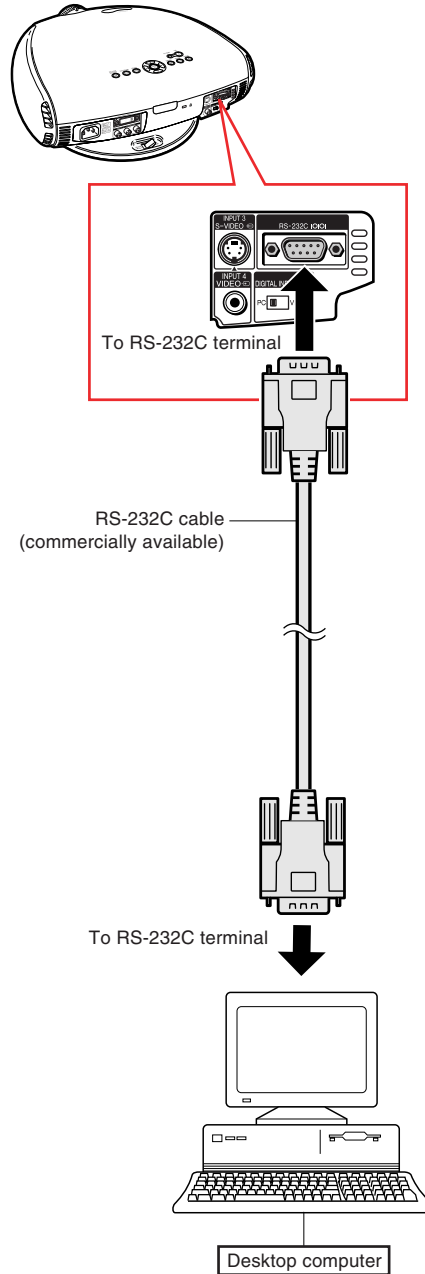



Setup

Using the Swivel Stand

You can adjust the angle and direction of the projected image by using the Swivel Stand.

1 Unlock the lever on the Swivel Stand.

2 Adjust the angle and direction of the projected image as you want by lifting up the projector and rotating the projector on the Swivel Stand.

⚠ Caution

- Do not hold the lens when lifting, lowering or rotating the projector.
- When lowering the projector, be careful not to get your fingers caught in the area between the Swivel Stand and the projector.

Note

- When the height or direction of the projector is adjusted, the image may become distorted (keystoned), depending on the relative positions of the projector and the screen. See page 33 for details on the keystone correction.

3 Lock the lever on the Swivel Stand.

Removing the Swivel Stand

1 Lift the projector (2) with pressing the removing-stand button on the back of the projector (1).

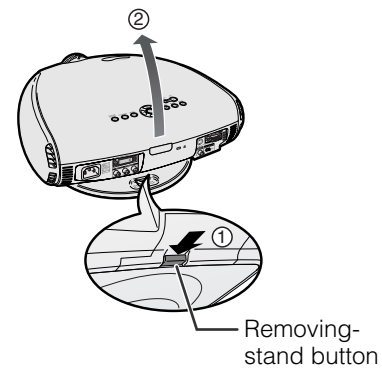
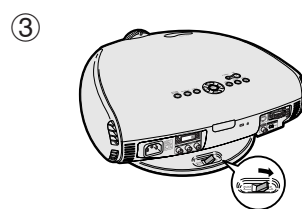
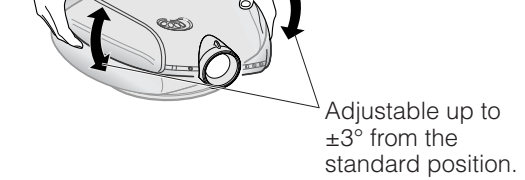
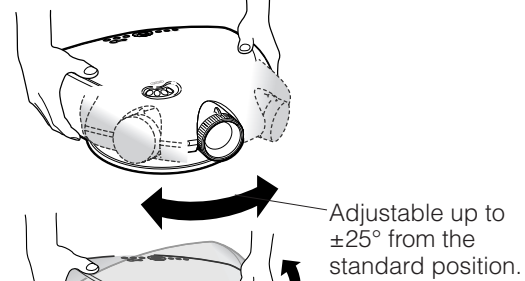
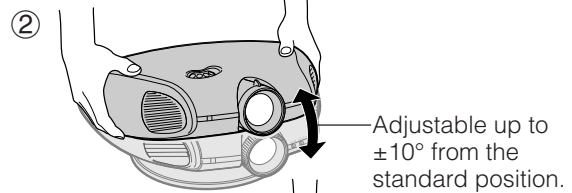
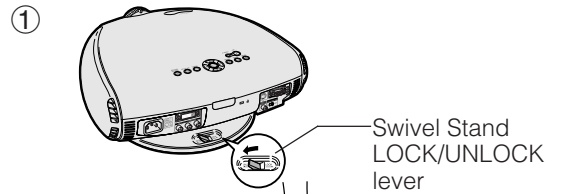



Attaching the Swivel Stand

- 1** Align the tabs on the front bottom of the projector (①).
- 2** While holding down the button (②), place the projector onto the Swivel Stand (③) to attach.
- 3** Press the projector down firmly to attach it to the Swivel Stand to make sure it is securely attached to the Swivel Stand.

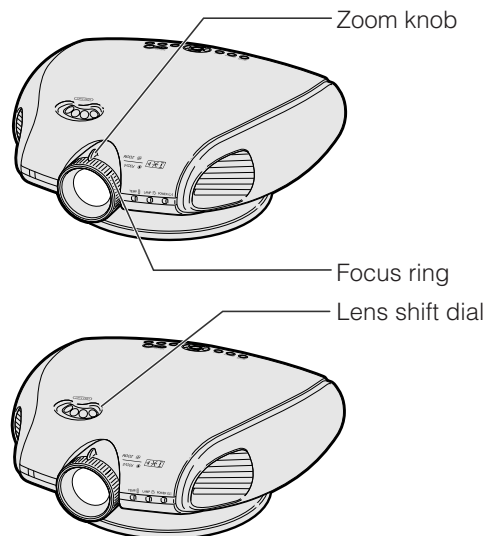
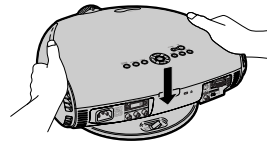
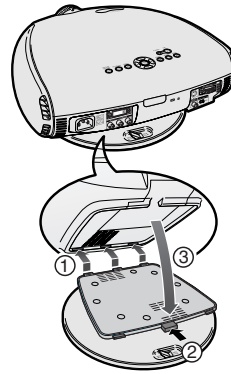

Focusing and Zooming

The picture can be focused and zoomed in or out by using the Focus ring and the Zoom knob.

- 1** Rotate the Focus ring until the image on the screen comes into focus.
- 2** Slide the Zoom knob. The image can be adjusted to the desired size within the zoom range.

Projected Image

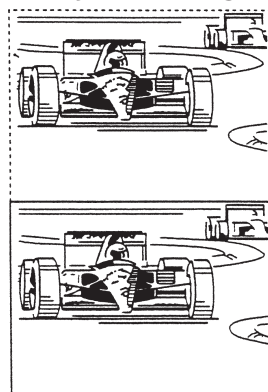

UP

DOWN

Using the Lens Shift

The picture can be adjusted within the shift range of the lens by rotating the lens shift dial on the top of the projector using your finger.



Setup

Adjusting the Projection Distance

- Refer to pages 33 and 34 about the function of Keystone correction and placement of projector using the correction.
- Decide the placement of the projector referring to the figures on the table and the diagram below according to the size of your screen and input signal.

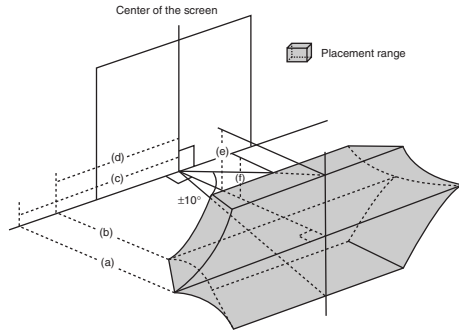

- (a) Maximum projection distance
- (b) Minimum projection distance
- (c) Horizontal placement range when projection distance is maximum.
- (d) Horizontal placement range when projection distance is minimum.
- (e) Vertical placement range when projection distance is maximum.
- (f) Vertical placement range when projection distance is minimum.

Note

- The aspect ratio of the projected image shifts slightly when the lens shift is at a position other than the top position.
- The aspect ratio of the projected image also shifts slightly when the "H Keystone" and "V Keystone" functions are adjusted simultaneously.
- When adjusting "H Keystone" and "V Keystone" at the same time, the values of adjustable angles for each setting become smaller.
- Keystone correction cannot be applied to On-screen Display.
- When Keystone correction is applied, the resolution of image can be deteriorated to some extent.
- There are errors of ±3% in the formulas below.

When using a wide screen (16:9)
In case of displaying the 16:9 picture on the whole of the 16:9 screen.

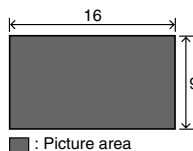

■ : Picture area

Screen size (16.9)(x)	Projection distance and Keystone correction										
	Diag.	Projection distance (a)	Maximum projection distance			Vertical placement range (e)	Projection distance (b)	Minimum projection distance			Vertical placement range (f)
			Composite, S-video 480iP, 1080i	720P	RGB			Composite, S-video 480iP, 1080i	720P	RGB	
200"	34' 6" (10.5m)	10' 6" (3.2m)	11' 10" (3.6m)	8' 6" (2.6m)	5' 11" (1.8m)	28' 7" (8.7m)	7' 7" (2.3m)	8' 2" (2.5m)	5' 11" (1.8m)	4' 11" (1.5m)	
150"	25' 10" (7.9m)	7' 10" (2.4m)	8' 10" (2.7m)	6' 7" (2.0m)	4' 3" (1.3m)	21' 5" (6.5m)	5' 7" (1.7m)	6' 3" (1.9m)	4' 3" (1.3m)	3' 7" (1.1m)	
133"	22' 11" (7.0m)	6' 11" (2.1m)	7' 10" (2.4m)	5' 7" (1.7m)	3' 11" (1.2m)	18' 12" (5.8m)	4' 11" (1.5m)	5' 7" (1.7m)	3' 11" (1.2m)	3' 3" (1.0m)	
106"	18' 3" (5.6m)	5' 7" (1.7m)	6' 3" (1.9m)	4' 7" (1.4m)	2' 11" (0.9m)	15' 1" (4.6m)	3' 11" (1.2m)	4' 3" (1.3m)	2' 11" (0.9m)	2' 7" (0.8m)	
100"	17' 2" (5.2m)	5' 3" (1.6m)	5' 11" (1.8m)	4' 3" (1.3m)	2' 11" (0.9m)	14' 3" (4.3m)	3' 7" (1.1m)	3' 11" (1.2m)	2' 11" (0.9m)	2' 4" (0.7m)	
92"	15' 10" (4.8m)	4' 7" (1.4m)	5' 3" (1.6m)	3' 11" (1.2m)	2' 7" (0.8m)	13' 1" (4.0m)	3' 3" (1.0m)	3' 7" (1.1m)	2' 7" (0.8m)	2' 4" (0.7m)	
84"	14' 5" (4.4m)	4' 3" (1.3m)	4' 11" (1.5m)	3' 7" (1.1m)	2' 4" (0.7m)	11' 11" (3.6m)	2' 11" (0.9m)	3' 3" (1.0m)	2' 4" (0.7m)	1' 12" (0.6m)	
72"	12' 4" (3.8m)	3' 7" (1.1m)	4' 3" (1.3m)	2' 11" (0.9m)	1' 12" (0.6m)	10' 3" (3.1m)	2' 7" (0.8m)	2' 11" (0.9m)	1' 12" (0.6m)	1' 8" (0.5m)	
60"	10' 3" (3.1m)	2' 11" (0.9m)	3' 3" (1.0m)	2' 4" (0.7m)	1' 8" (0.5m)	8' 6" (2.6m)	2' 4" (0.7m)	2' 4" (0.7m)	1' 8" (0.5m)	1' 4" (0.4m)	
40"	6' 10" (2.1m)	1' 12" (0.6m)	2' 4" (0.7m)	1' 8" (0.5m)	12" (0.3m)	5' 7" (1.7m)	1' 4" (0.4m)	1' 4" (0.4m)	12" (0.3m)	8" (0.2m)	

(a) = (0.052833802x - 0.038639669) / 0.3048 x: Screen size (diag.)
(b) = (0.043798292x - 0.038804856) / 0.3048

When using a normal screen (4:3)
In case of setting the 16:9 picture to the full horizontal width of the 4:3 screen.

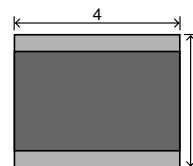

■ : Screen area
■ : Picture area

Screen size (4.3)(x)	Projection distance and Keystone correction										
	Diag.	Projection distance (a)	Maximum projection distance			Vertical placement range (e)	Projection distance (b)	Minimum projection distance			Vertical placement range (f)
			Composite, S-video 480iP, 1080i	720P	RGB			Composite, S-video 480iP, 1080i	720P	RGB	
200"	-	-	-	-	-	26' 3" (8.0m)	6' 11" (2.1m)	7' 7" (2.3m)	5' 3" (1.6m)	4' 7" (1.4m)	
150"	23' 9" (7.2m)	7' 3" (2.2m)	8' 2" (2.5m)	5' 11" (1.8m)	3' 11" (1.2m)	19' 8" (6.0m)	5' 3" (1.6m)	5' 7" (1.7m)	3' 11" (1.2m)	3' 3" (1.0m)	
100"	15' 9" (4.8m)	4' 7" (1.4m)	5' 3" (1.6m)	3' 11" (1.2m)	2' 7" (0.8m)	13' 1" (4.0m)	3' 3" (1.0m)	3' 7" (1.1m)	2' 7" (0.8m)	2' 4" (0.7m)	
84"	13' 3" (4.0m)	3' 11" (1.2m)	4' 7" (1.4m)	3' 3" (1.0m)	2' 4" (0.7m)	10' 11" (3.3m)	2' 11" (0.9m)	2' 11" (0.9m)	1' 12" (0.6m)	1' 8" (0.5m)	
72"	11' 4" (3.5m)	3' 3" (1.0m)	3' 11" (1.2m)	2' 7" (0.8m)	1' 12" (0.6m)	9' 4" (2.9m)	2' 4" (0.7m)	2' 7" (0.8m)	1' 8" (0.5m)	1' 8" (0.5m)	
60"	9' 5" (2.9m)	2' 7" (0.8m)	2' 11" (0.9m)	2' 4" (0.7m)	1' 8" (0.5m)	7' 9" (2.4m)	1' 12" (0.6m)	1' 12" (0.6m)	1' 4" (0.4m)	1' 4" (0.4m)	
40"	6' 3" (1.9m)	1' 8" (0.5m)	1' 4" (0.4m)	1' 4" (0.4m)	12" (0.3m)	5' 2" (1.6m)	1' 4" (0.4m)	1' 4" (0.4m)	12" (0.3m)	8" (0.2m)	

(a) = (0.04849498x - 0.038639669) / 0.3048 x: Screen size (diag.)
(b) = (0.040201488x - 0.038804856) / 0.3048



Upper and Lower Lens Shift Position

- This projector is equipped with a lens shift function that lets you adjust the projection height.
- Adjust the projection height to match the setup configuration.
- The screen can be moved maximum the length of one screen vertically using the lens shift.

Note

- Optimal image quality is produced with the projector positioned perpendicular to the screen with all feet flat and level. Tilting or angling the projector will reduce the effectiveness of the lens shift function.

Screen size: 100 inches (254 cm)
Aspect ratio: 16:9

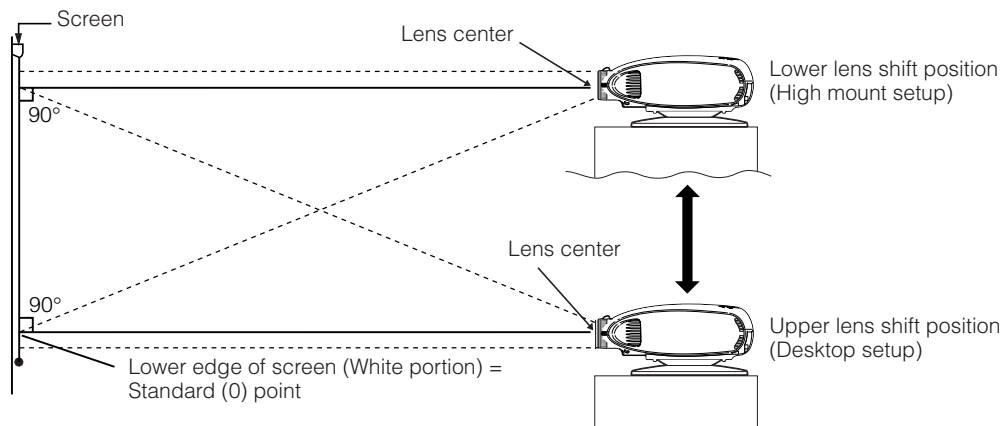

Upper and Lower Lens Shift Position (Ceiling Mount)

When the projector is in the inverted position, use the upper edge of the screen as the base line, and exchange the lower and upper lens shift values.

Screen size: 100 inches (254 cm)
Aspect ratio: 16:9

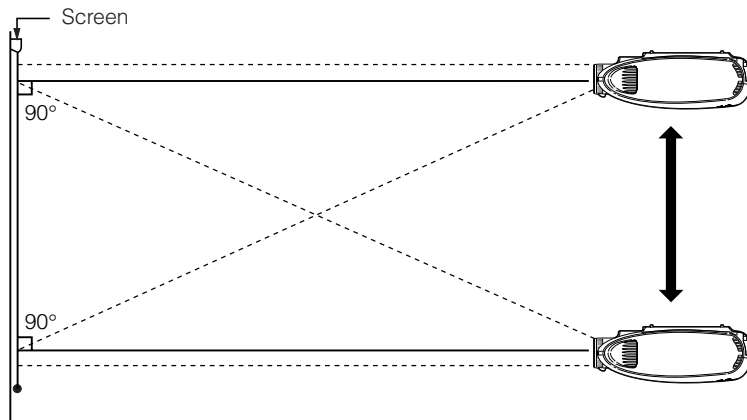



Setup

Image Projection

Rear Projection

- Place a translucent screen between the projector and the audience.
- Use the projector's menu screen to reverse the projected image. (See page 56 for use of this function.)

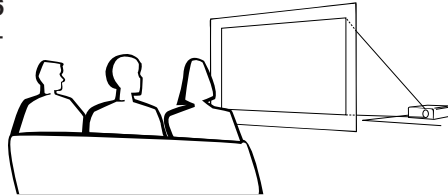

Note

- Optimal image quality can be achieved when the projector is positioned perpendicular to the screen with all feet flat and leveled.

Projection using a mirror

- Place a mirror (normal flat type) in front of the lens.

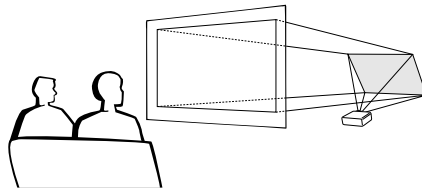

Info

- When using a mirror, be sure to carefully position both the projector and the mirror so the light does not shine into the eyes of the audience.

Ceiling-mount setup

- It is recommended that you use the optional Sharp ceiling-mount bracket for this installation.
- Before mounting the projector, remove the Swivel Stand. (See pages 24 and 25 for removing and attaching the Swivel Stand.)
- Before mounting the projector, contact your nearest Authorized SharpVision Service Center or Dealer to obtain the recommended ceiling-mount bracket (sold separately). (AN-CM260 ceiling-mount bracket, AN-EP101B extension tube for AN-CM260.)
- When the projector is in the inverted position, use the upper edge of the screen as the base line.
- Use the projector's menu screen to select the appropriate projection mode. (See page 56 for use of this function.)

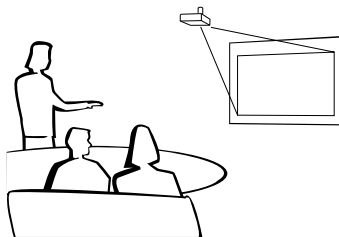

When using the default setting.

▼On-screen Display



The image is reversed.

When using the default setting.

▼On-screen Display

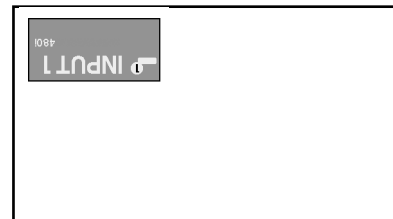

The image is inverted.



Basic Operation

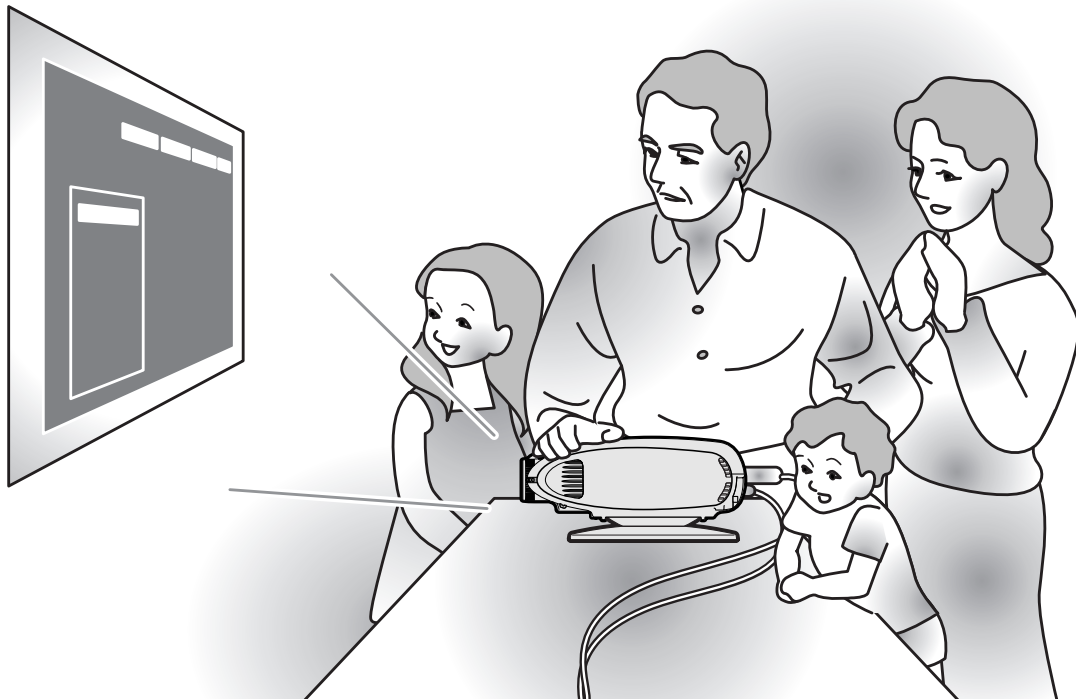

Basic Operation



Image Projection

Basic Procedure

Connect the required external equipment to the projector before operating the following procedures.

Info

- The language preset at the factory is English. If you want to change the on-screen display to another language, reset the language according to the procedure on page 31.

1 Plug the power cord into the wall outlet.

- The POWER indicator illuminates red, and the projector enters standby mode.

2 Press on the remote control or on the projector.

- The blinking green LAMP indicator shows that the lamp is warming up. Wait until the indicator stops blinking before operating the projector.
- If the power is turned off and then immediately turned on again, it may take a short while before the lamp turns on.

Note

- After the projector is unpacked and turned on for the first time, a slight odor may be emitted from the exhaust ventilative holes. This odor will soon disappear with use.

When the power is on, the LAMP indicator illuminates, indicating the status of the lamp.

Green: Lamp is ready.

Green blinking: Warming up. / Cooling down.

Red: Change the lamp.

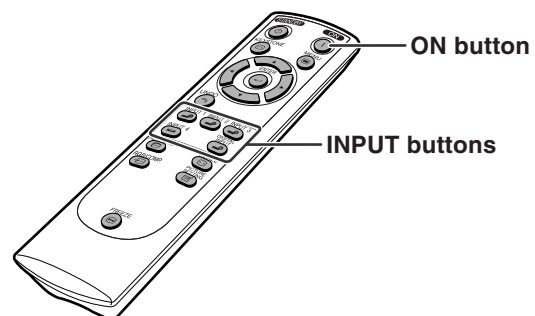
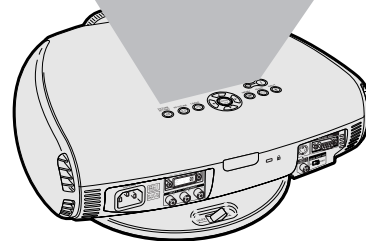
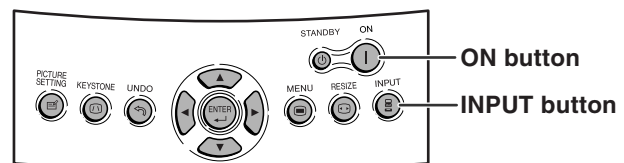
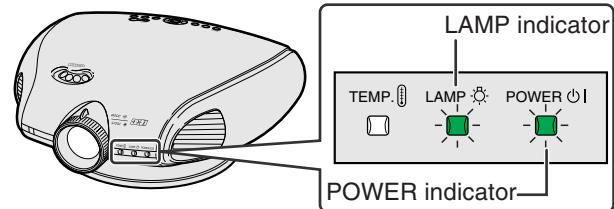



3 Press or on the remote control or on the projector to select the INPUT mode.

- After pressing once on the projector, use to select the desired input mode.

Note

- When no signal is received, “NO SIGNAL” will be displayed. When a signal that the projector is not preset to receive is received, “NOT REG.” will be displayed.

About the INPUT modes

INPUT 1 (Component)	Used for projecting images from equipment connected to INPUT 1 terminals.
INPUT 2 (Component/RGB)	Used for projecting images from equipment connected to INPUT 2 terminal.
INPUT 3 (S-Video)	Used for projecting images from equipment connected to INPUT 3 terminal.
INPUT 4 (Video)	Used for projecting images from equipment connected to INPUT 4 terminal.
DIGITAL	Used for projecting images from equipment connected to DIGITAL INPUT terminal.

Selecting the On-screen Display Language

English is the preset language for the On-screen Display; however, this can be changed to German, Spanish, Dutch, French, Italian, Swedish, Portuguese, Chinese, Korean or Japanese.

Display the “Language” menu and select the desired Language.
→For operating the menu screen, see pages 38 to 41.

▼ On-screen Display (Example)

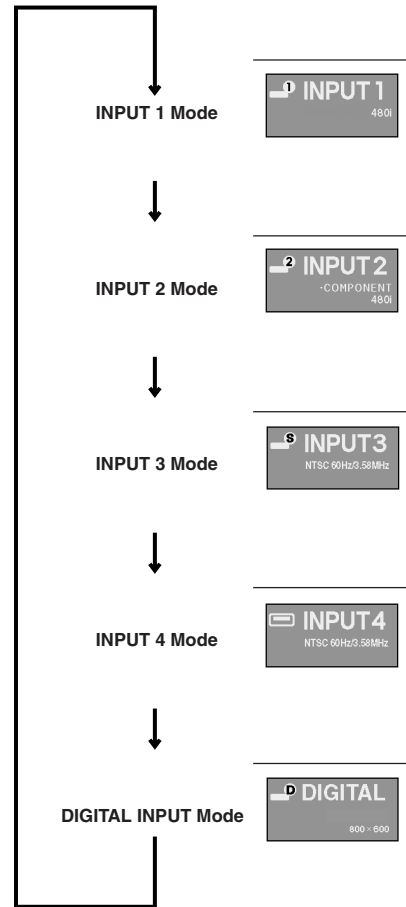

Basic Operation





On-screen Display





Image Projection

Turning the Power off

- 1** Press  on the remote control or  on the projector, then press  or  again while the confirmation message is displayed, to put the projector into the standby mode.

- A dimly-lit screen is displayed for a short time to reduce lamp damage.

Note

- If you accidentally pressed  and do not want to put the projector into the standby mode, wait until the confirmation message disappears.

- 2** Unplug the power cord from the AC outlet after the cooling fan stops.

Info

- Do not unplug the power cord during projection or cooling fan operation. This can cause damage due to the rise in internal temperature, as the cooling fan also stops.
- When connected to equipment such as an amplifier, be sure to turn off the power to the equipment connected first and then to the projector.

E-32

STANDBY button

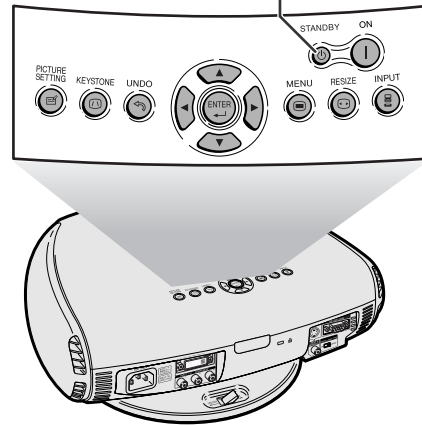

STANDBY button

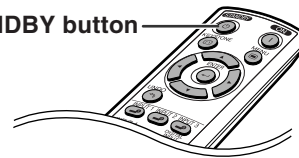

Enter STANDBY mode?

Yes: Press Again. No: Please Wait.



Shutting down. Please wait.





Keystone Correction

This function can be used to adjust the Keystone settings.



Note

- For details about using the menu screen, see pages 38 to 41.

1 Press  on the projector or on the remote control.

2 Press / to select “H Keystone” or “V Keystone”.

Selected Item	Description
H Keystone	Horizontally adjusts the keystone settings.
V Keystone	Vertically adjusts the keystone settings.
Reset	V and H Keystone adjustments are returned to the factory preset settings.

3 Press / to move the  mark on the selected adjustment item to the desired setting.

Note

- Straight lines and the edges of the displayed image may appear jagged, when adjusting the Keystone setting.
- When adjusting “H Keystone” and “V Keystone” at the same time, the values of adjustable angles for each setting become smaller.
- The adjustable value of the “V Keystone” becomes extremely small when “H Keystone” is made to be the maximum value.
- Keystone correction is disabled while the picture mode is set to “SMART STRETCH”. (See page 35.)

4 To return to the normal screen, press  again.

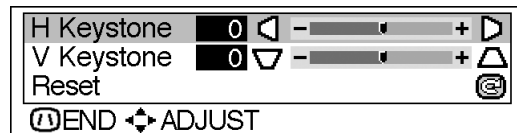
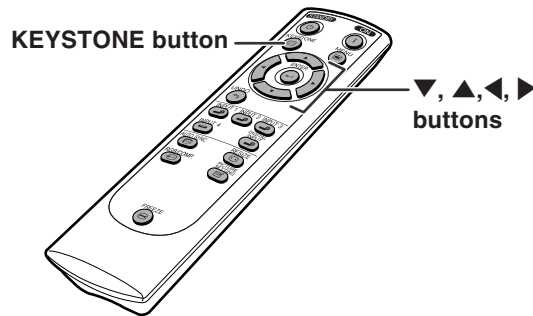
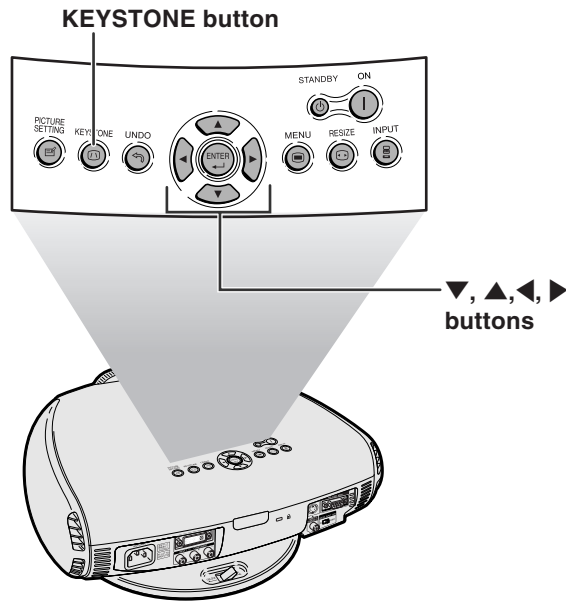

Horizontal Keystone Correction

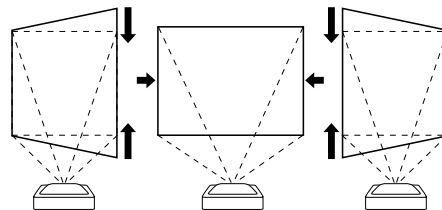

Vertical Keystone Correction

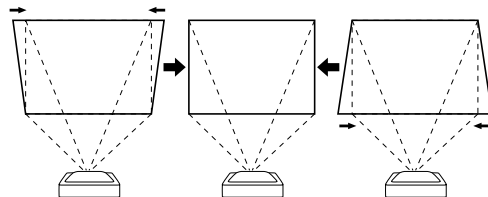



Image Projection

Placement of the Projected Image Using the Keystone Correction

Place the projector at a distance from the screen that allows images to be projected onto the screen by referring to “Adjusting the Projection Distance” on pages 26 and 27.

- 1** Project the test pattern of the Keystone correction function onto the screen. Rotate the Focus ring until the image on the screen comes into focus. (See page 25.)
- 2** Change the projection angle using the Swivel Stand to properly project images onto the screen. (See page 24).
- 3** Align the edge of the screen closest to the projector with the test pattern by adjusting the zoom and the Swivel Stand. (See pages 24 and 25.)
- 4** Adjust the Keystone function so that the size of the projected image matches the screen size. (See page 33.)
- 5** Align the image on the screen by adjusting the zoom function and the Swivel Stand.
- 6** Adjust the focus so that the projected image is in focus at the center of the screen. (See page 25.)

Note

- The aspect ratio of the projected image shifts slightly when the lens shift is at a position other than the top position.
- The aspect ratio of the projected image also shifts slightly when the “H Keystone” and “V Keystone” functions are adjusted simultaneously.

(E)-34

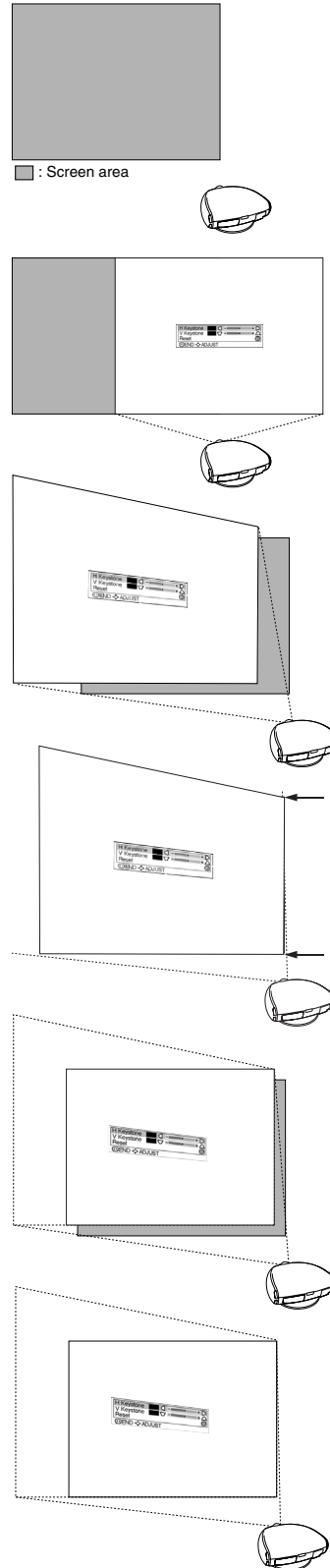



Freezing a Moving Image

You can instantly freeze a moving image with the remote control.

- 1 Press .
 - The projected image is frozen.

- 2 Press  again to return to the moving image from the currently connected device.

Adjusting the Picture Aspect Ratio

This function allows you to modify or customize the picture display mode to enhance the input image. Depending on the input signal, you can choose SIDE BAR, SMART STRETCH, CINEMA ZOOM or STRETCH image.

Press . Each time  is pressed, the picture mode changes as shown on the next page.

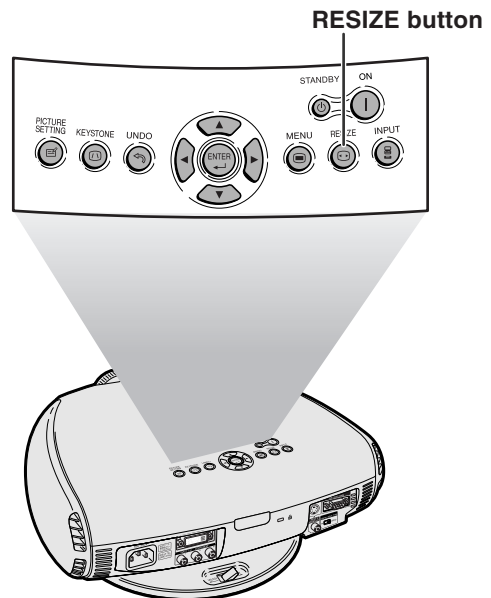
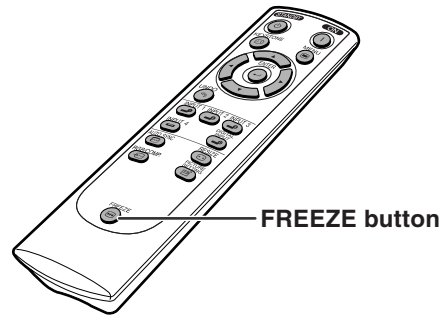
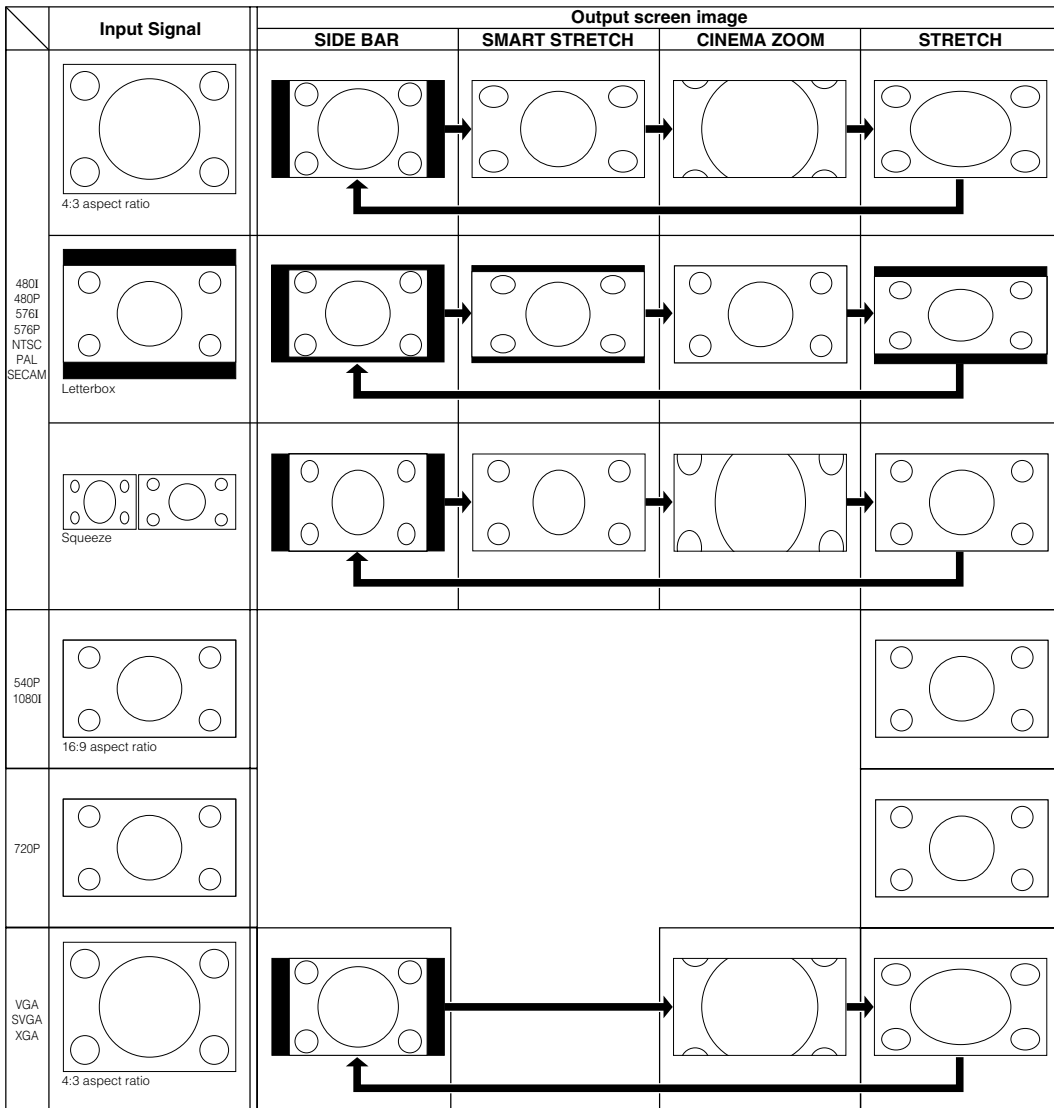



Image Projection

		SIDE BAR	SMART STRETCH	CINEMA ZOOM	STRETCH
For 4:3 aspect ratio	480I 480P 576I 576P NTSC PAL SECAM VGA SVGA XGA	768 × 576	1024 × 576	1024 × 576	1024 × 576
For 16:9 aspect ratio	480P	768 × 576	1024 × 576	1024 × 576	1024 × 576
	720P	-	-	-	1024 × 576
	1080I	-	-	-	1024 × 576

- "STRETCH" is fixed when 540P, 720P or 1080I signal is entered.
- "SMART STRETCH" cannot be selected while input signal from a computer (VGA, SVGA or XGA) is entered.



Note

- "SMART STRETCH" cannot be selected while the Keystone correction (page 33) is being adjusted.
- Keystone correction (page 33) is disabled while the picture mode is set to "SMART STRETCH".
- 580I/580P is displayed on the screen when signal 576I/576P is input.





Adjustments and Settings

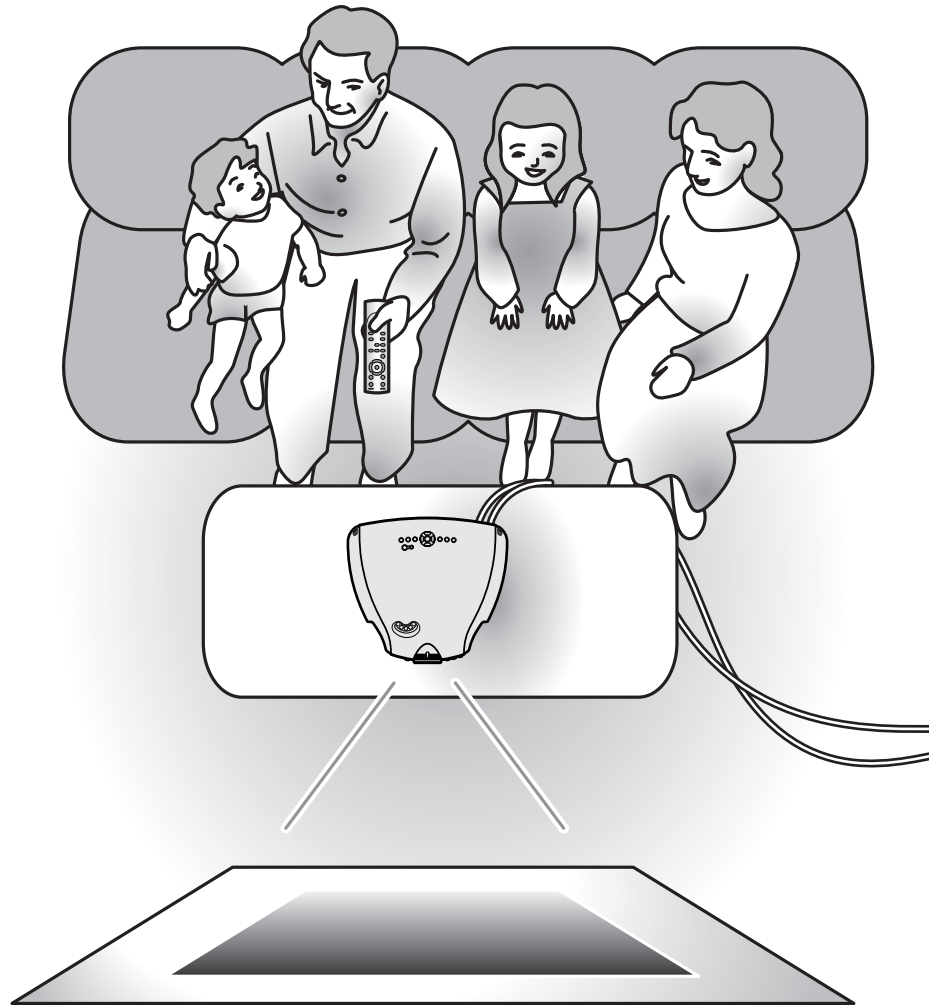

Adjustments and Settings



Using the Menu Screen

The menu screens allow you to adjust the image and various projector settings. The menu can be operated to achieve two functions, adjustment and setting. (For adjusting the menu items, see pages 38 and 39. For setting the menu items, see pages 40 and 41.)

Menu screen (example)

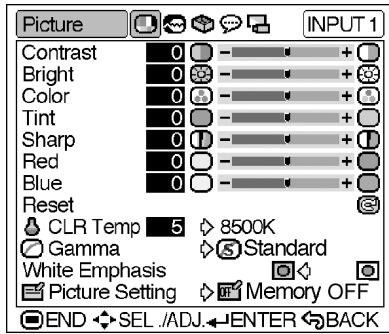

Menu Selections (Adjustments)

1 Press .

- The menu screen is displayed.

Note

- The "Picture" menu screen for the selected input mode is displayed.

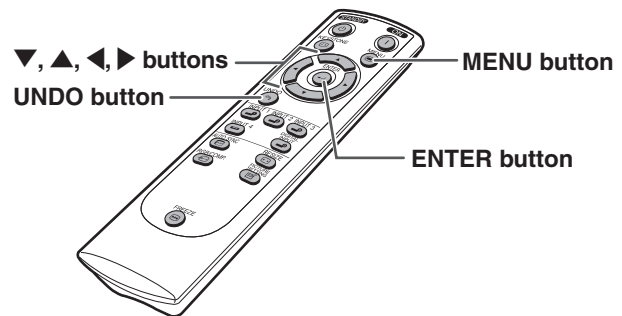
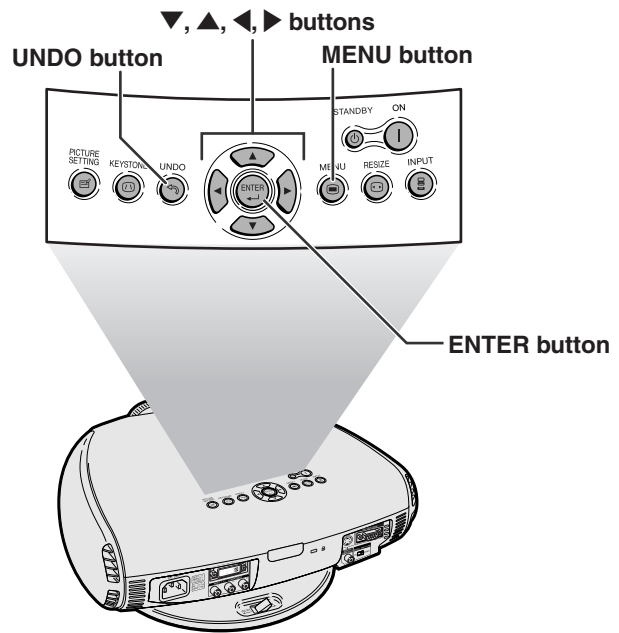



2 Press ◀ or ▶ to display the other menu screens.

- The menu icon for the selected menu screen is highlighted.

Menu icon	Menu screen
	Picture
	Fine Sync
	Options
	Language
	PRJ Mode

Note

- The “Fine Sync” menu is not available for INPUT 3 or 4.
- For items on the menus, see the tree charts on pages 42 and 43.

3 Press ▼ or ▲ to select the item you want to adjust.

Note

- To display a single adjustment item, press after selecting the item. Only the menu bar and the selected adjustment item will be displayed. Then if you press ▼ or ▲, the following item (“Bright” after “Contrast”) will be displayed.
- Press to return to the previous screen.

4 Press ◀ or ▶ to adjust the item selected.

- The adjustment is stored.

5 Press .

- The menu screen will disappear.

Select the menu icon.

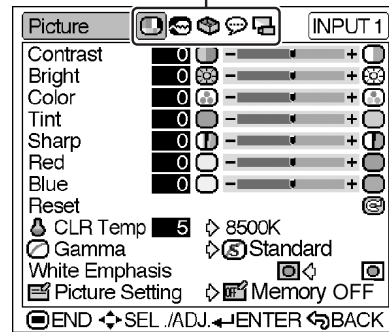

Select the item.

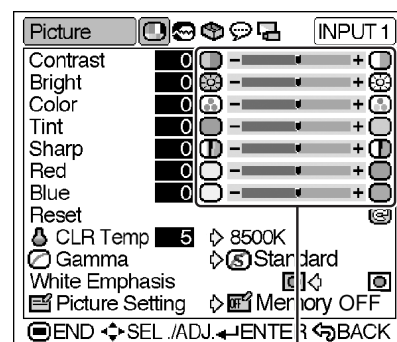
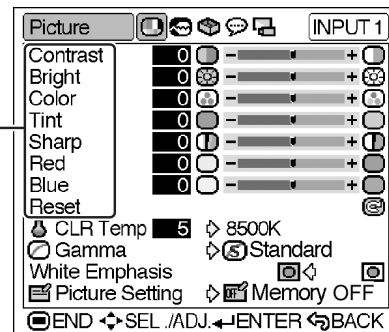

Adjust the item.



Using the Menu Screen



Menu Selections (Settings)

1 Press .





- The menu screen is displayed.

 **Note**

- The "Picture" menu screen for the selected input mode is displayed.

2 Press  or  to display the other menu screens.

- The menu icon for the selected menu screen is highlighted.

Menu icon	Menu screen
	Picture
	Fine Sync
	Options
	Language
	PRJ Mode

 **Note**

- The "Fine Sync" menu is not available for INPUT 3 or 4.
- For items on the menus, see the tree charts on pages 42 and 43.

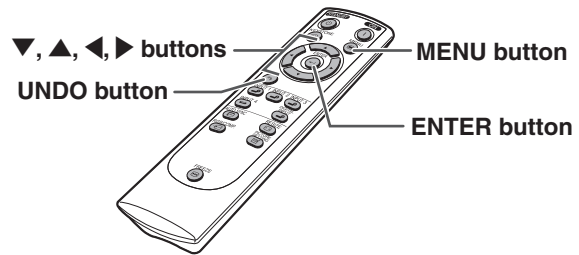
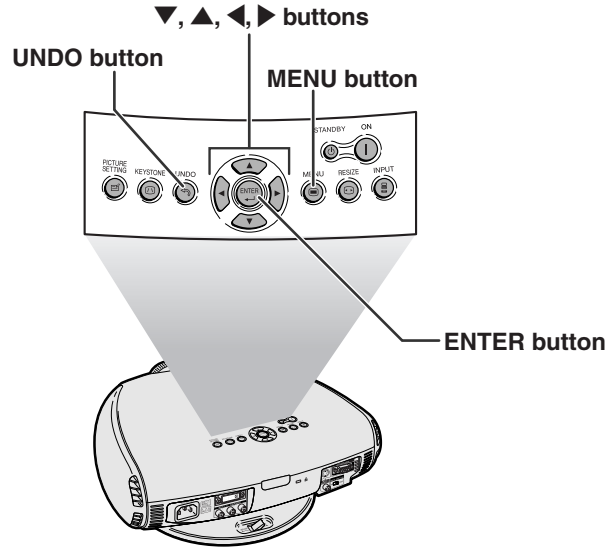

Select the menu icon.

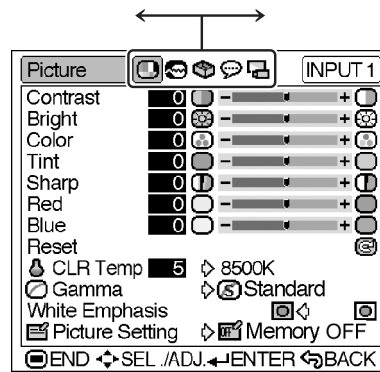



3 Press ▼ or ▲ to select the item you want to set.

Note

- Press to return to the previous screen.
- In some menus, select the icon using “→”.

4 Press ▶.

- The sub menu is displayed.

5 Press ▼ or ▲ to select the setting of the item displayed in the sub menu.

6 Press .

- The item selected is set.

7 Press .

- The menu screen will disappear.

Select the item.

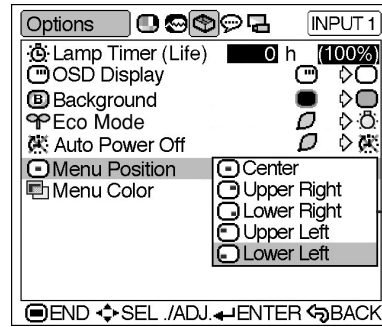
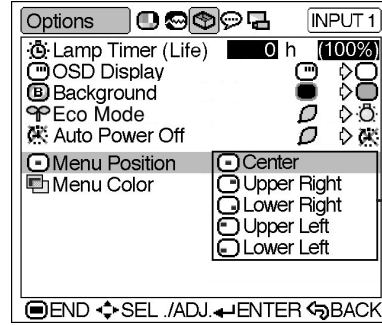
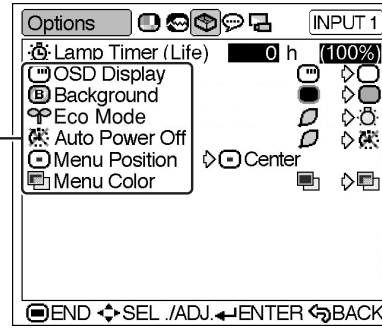



Menu Bar Items

INPUT 1 / 2 / DIGITAL INPUT Mode

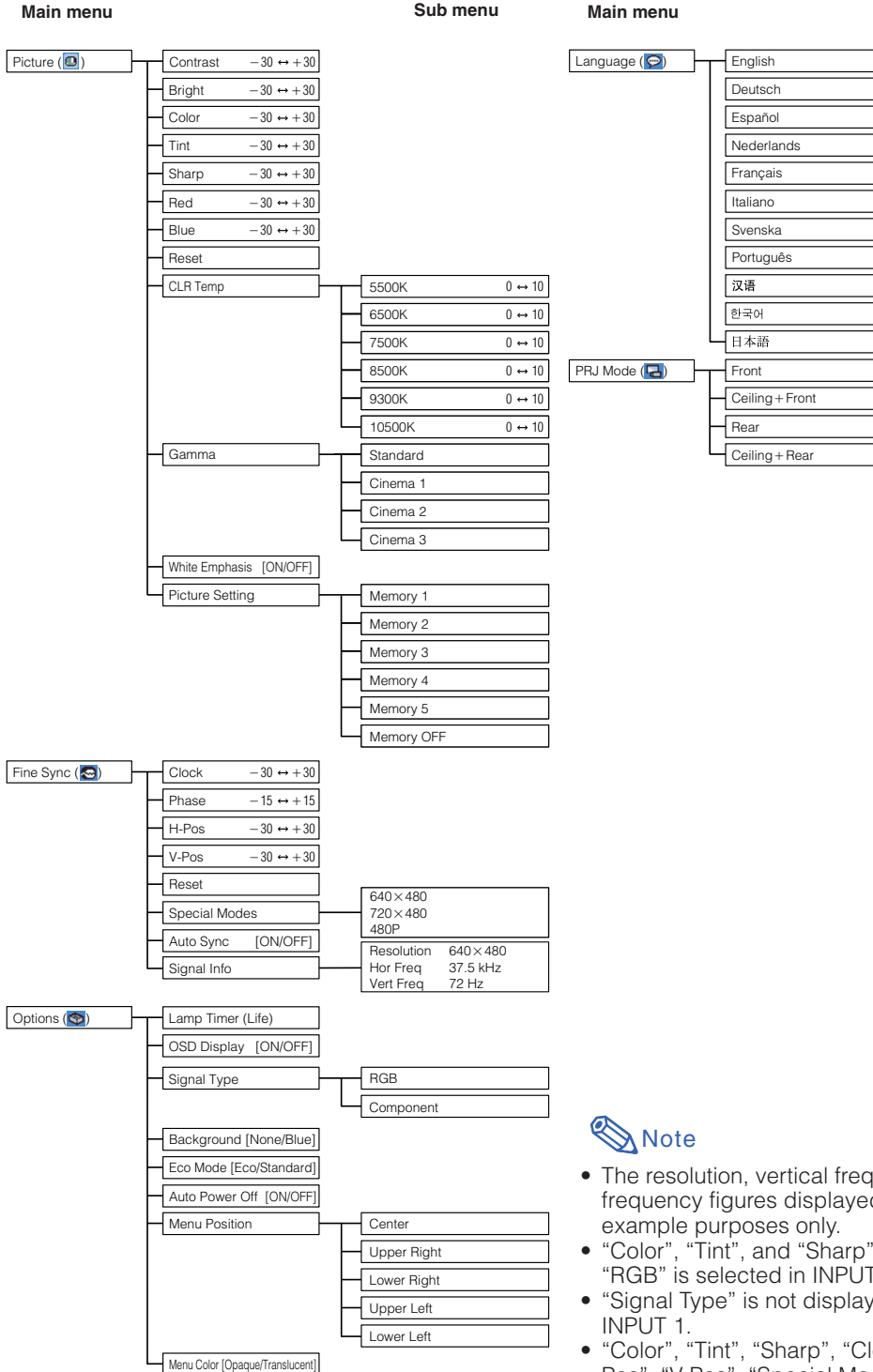

Note

- The resolution, vertical frequency and horizontal frequency figures displayed above are for example purposes only.
- “Color”, “Tint”, and “Sharp” do not appear when “RGB” is selected in INPUT 2 mode.
- “Signal Type” is not displayed when using INPUT 1.
- “Color”, “Tint”, “Sharp”, “Clock”, “Phase”, “H-Pos”, “V-Pos”, “Special Modes” and “Auto Sync” cannot be used in the DIGITAL INPUT mode.
- “Clock”, “Phase” and “Auto Sync” cannot be used in the Component mode.



INPUT 3 / 4 Mode

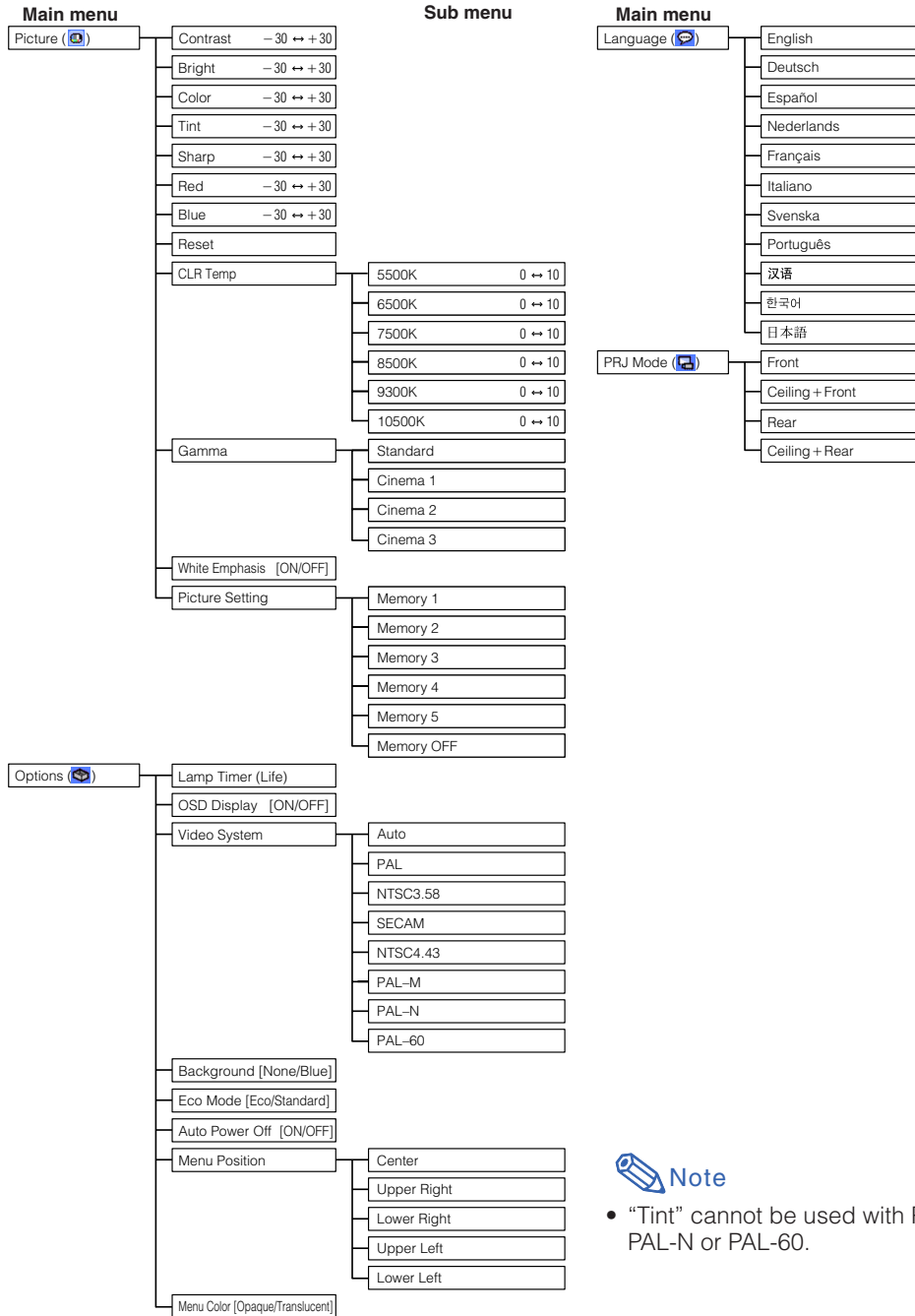

Note

- "Tint" cannot be used with PAL, SECAM, PAL-M, PAL-N or PAL-60.



Adjusting the Picture

You can adjust the projector's picture to your preferences with the following picture settings.

Adjusting Image Preferences

Note

- First select "Memory 1-5" or "Memory OFF" when you want to save the "Picture" menu settings. See page 47 for details.

Adjust the "Picture" menu on the menu screen.

→For operating the menu screen, see pages 38 to 41.

On-screen Display

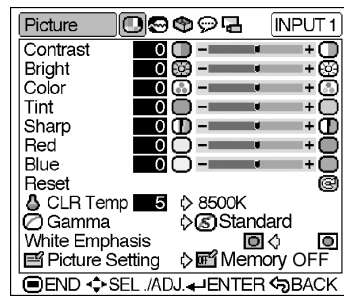

Selected Item	Description	◀ button	▶ button
Contrast	For adjusting the contrast level	For less contrast	For more contrast
Bright	For adjusting the brightness of an image	For less brightness	For more brightness
Color	For adjusting the color intensity of an image	For less color intensity	For more color intensity
Tint	For adjusting the tones of an image	Skin tones become purplish	Skin tones become greenish
Sharp	For making sharper or softer the contour of an image	For less sharpness	For more sharpness
Red	For adjusting the redness of an image	For weaker red	For stronger red
Blue	For adjusting the blueness of an image	For weaker blue	For stronger blue

Note

- "Color", "Tint" and "Sharp" do not appear for RGB input in INPUT 2 mode.
- To reset all adjustment items, select "Reset" on the "Picture" menu screen and press .
- "Tint" cannot be used with PAL, SECAM, PAL-M, PAL-N or PAL-60.
- "Color", "Tint" and "Sharp" cannot be used in the DIGITAL INPUT mode.



Adjusting the Color Temperature

This function allows for selecting the desired color temperature. With the lower value selected, the projected image becomes warmer, reddish and incandescent-like while with the higher value, the image becomes cooler, bluish and fluorescent-like.

Select “CLR Temp” in the “Picture” menu on the menu screen.



→For operating the menu screen, see pages 38 to 41.



Selected Item	Description
5500K	The less the value is set to, the warmer, reddish, incandescent-like the image becomes.
6500K	
7500K	
8500K	The more the value is set to, the cooler, bluish, fluorescent-like the image becomes.
9300K	
10500K	

“CLR Temp” is fine adjusted by following the procedure below.

1 Select “CLR Temp” in the “Picture” menu on the menu screen and press .

- A single menu bar of “CLR Temp” is displayed.

2 Press  or  to fine adjust the color temperature.

- With the lower value selected, the projected image becomes magenta-tinged. With the higher value selected, the projected image becomes green-tinged.
- Pressing  or  changes the value of the color temperature in the sub menu.

Note

- Values on “CLR Temp” are only for general standard purposes.

On-screen Display

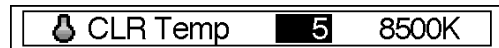
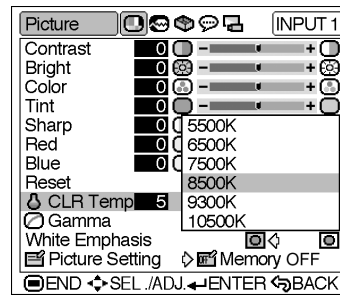



Adjusting the Picture

Gamma Correction Function

Gamma is an image quality enhancement function.

Four gamma settings are available to allow for differences in the brightness of the room.

Select “Gamma” in the “Picture” menu on the menu screen.

→For operating the menu screen, see pages 38 to 41.

Selected Item	Description
Standard	Standard picture without gamma correction
Cinema 1	Gives greater depth to darker portions of images.
Cinema 2	Brightness is toned down and the image becomes more balanced.
Cinema 3	Brighten the darker portions of images for easier viewing in a dimly lit room.

Emphasizing the Contrast

This function emphasizes the bright portions of images to obtain a higher contrast image.

Select “White Emphasis” in the “Picture” menu on the menu screen.

→For operating the menu screen, see pages 38 to 41.

Selected Item	Description
<input checked="" type="checkbox"/> (ON)	For emphasizing the bright portions of images
<input type="checkbox"/> (OFF)	For disabling “White Emphasis”

On-screen Display

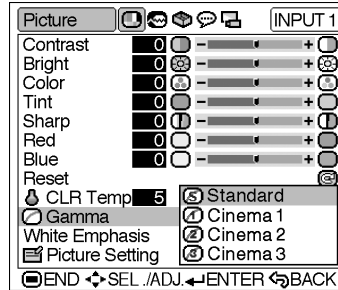

On-screen Display

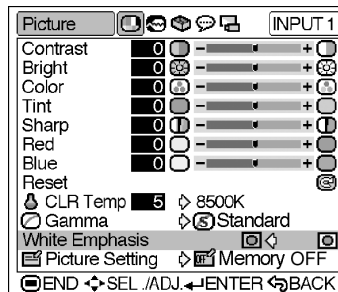



Picture Setting Function

This function stores all items set in “Picture”. Five settings can be stored separately in “Memory 1” to “Memory 5”. Each stored setting is reassigned to each input mode (INPUT 1 to INPUT 4 and DIGITAL).

Even when the input mode or signal is changed, you can easily select optimal settings from the stored settings.

Storing the Adjustment Values for Each Memory Number

Select “Picture Setting” on the “Picture” menu and the memory location where you want to store the settings. Then adjust the setting items on the “Picture” menu.

→For operating the menu screen, see pages 38 to 41.

Selected Item	Description
Memory 1-5	Settings of all items in “Picture” can be stored for the respective input modes. The stored settings can be selected in any input modes.
Memory OFF	Besides “Memory 1” to “Memory 5”, other settings on the “Picture” menu can be stored for each input mode. The settings stored in “Memory OFF” cannot be applied when another input mode is selected.

Applying the Stored Settings

If you want to apply the stored settings on the “Picture” menu, select “Picture Setting” on the “Picture” menu and the memory location where you have stored the settings.

Note

- This function can be operated using the on the projector or on the remote control, as well as the OSD menu screen. Each time or is pressed, the memory number changes as shown below.

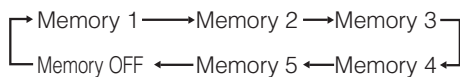

On-screen Display

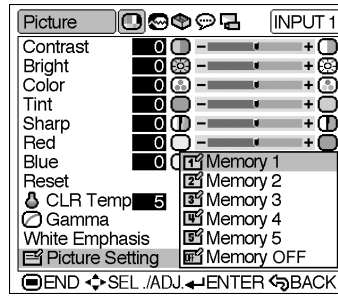

PICTURE SETTING button

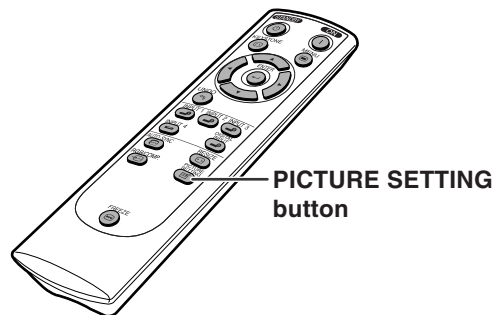
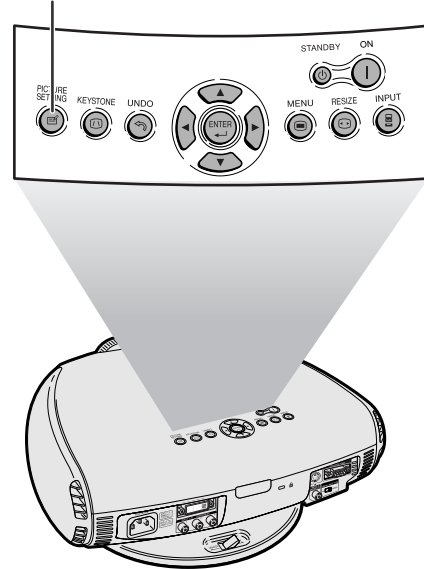

Adjusting the Computer and DVD/DTV Images

Use the Fine Sync function in case of irregularities such as vertical stripes or flickering in portions of the screen.

When Auto Sync is OFF

When "Auto Sync" is "OFF", interference such as flickering or vertical stripes may occur if displaying tilings or vertical stripes. Should this occur, adjust "Clock", "Phase", "H-Pos" and "V-Pos" for obtaining an optimum image.

Select "Clock", "Phase", "H-Pos" or "V-Pos" in the "Fine Sync" menu on the menu screen.

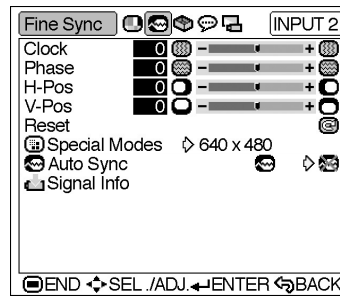

→For operating the menu screen, see pages 38 to 41.

On-screen Display



Selected Item	Description
Clock	Adjusts vertical noise.
Phase	Adjusts horizontal noise (similar to tracking on your VCR).
H-Pos	Centers the on-screen image by moving it to the left or right.
V-Pos	Centers the on-screen image by moving it up or down.

Note

- "Clock", "Phase", "H-Pos" and "V-Pos" cannot be used in the DIGITAL INPUT mode.
- "Clock" and "Phase" cannot be used in the Component mode.
- Computer image adjustments can be made easily by pressing  on the remote control. See page 50 for details.
- To reset all adjustment items, select "Reset" on the "Fine Sync" menu screen and press .
- The adjustable area of each item may be changed according to the input signal.



Special Modes Adjustment

Ordinarily, the type of input signal is detected and the correct resolution mode is automatically selected. However, for some signals, the optimal resolution mode in “Special Modes” on the “Fine Sync” menu screen may need to be selected to match the computer display mode.

Set the resolution by selecting “Special Modes” in the “Fine Sync” menu on the menu screen.

→For operating the menu screen, see pages 38 to 41.

Note

- Avoid displaying computer patterns which repeat every other line (horizontal stripes). (Flickering may occur, making the image hard to see.)
- When inputting DTV 1080I signal, select the corresponding type of signal.
- When inputting 720P signal from the video equipment, select “720P”. When inputting 1280 × 720 signal from the computer, select “HTPC”.
- “Special Modes” cannot be used in the DIGITAL INPUT mode.

On-screen Display

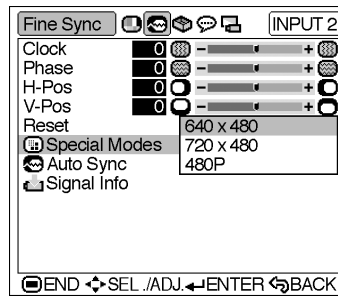



Adjusting the Computer and DVD/DTV Images



Auto Sync Adjustment

Used to automatically adjust a computer image.

Select whether the image is to be synchronized automatically when switching the signal with "ON" or "OFF".

Select "Auto Sync" in the "Fine Sync" menu on the menu screen.

→For operating the menu screen, see pages 38 to 41.

Selected Item	Description
 (ON)	Auto Sync adjustment will occur when the projector is turned on or when the input signals are switched, when connected to a computer.
 (OFF)	Auto Sync adjustment is not automatically performed.

Note

- When the optimum image cannot be achieved with Auto Sync adjustment, use manual adjustments. (See page 48.)
- The Auto Sync adjustment may take some time to complete, depending on the image of the computer connected to the projector.
- "Auto Sync" cannot be used in the DIGITAL INPUT mode.
- Auto Sync adjustment is also performed by pressing  on the remote control.

Checking the Input Signal

This function allows you to check the current input signal information.

Select "Signal Info" in the "Fine Sync" menu on the menu screen.

→For operating the menu screen, see pages 38 to 41.

Note

- 540P is displayed on the screen when signal 1080I is inputted during DVI connection.

On-screen Display

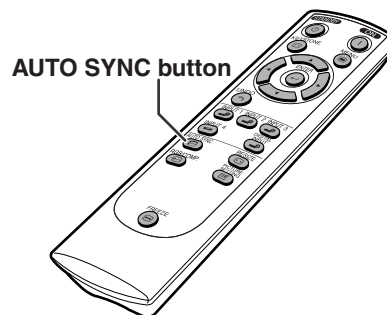
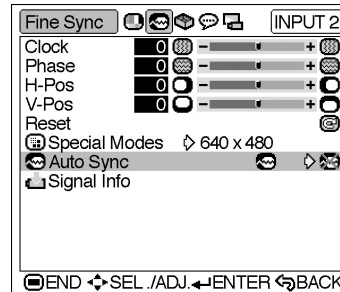

On-screen Display

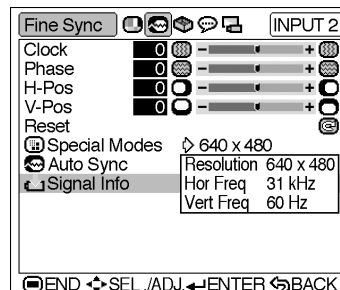



Using the “Options” Menu

Checking the Lamp Life Status

You can confirm the cumulative lamp usage time and the remaining lamp life (percentage).

Display the “Options” menu to check the lamp life status.
→For operating the menu screen, see pages 38 to 41.

Lamp usage condition	Remaining lamp life	
	100%	5%
Operated exclusively in Eco mode (Eco icon)	Approx. 4,000 hours	Approx. 200 hours
Operated exclusively in Standard mode (Standard icon)	Approx. 3,000 hours	Approx. 150 hours

Note

- It is recommended that the lamp be changed when the remaining lamp life becomes 5%. For lamp replacement, contact your nearest Authorized SharpVision Service Center or Dealer.
- The table above indicates rough estimates in the case of using only in each mode shown. Remaining lamp life changes within the range of the values shown depending on the frequency at which “Eco Mode” is switched to “Eco mode” and “Standard mode” (see page 53).

On-screen Display

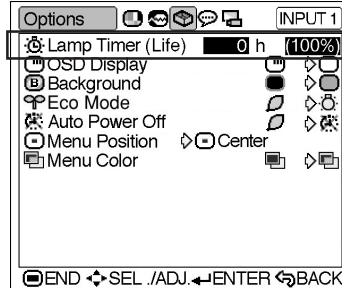

Turning on/off the On-screen Display

This function allows you to turn on or off the on-screen messages that appear during input select.

Select “OSD Display” in the “Options” menu on the menu screen.
→For operating the menu screen, see pages 38 to 41.

Selected Item	Description
<input checked="" type="checkbox"/> (ON)	All On-screen Displays are displayed.
<input type="checkbox"/> (OFF)	INPUT/FREEZE/AUTO SYNC/“An invalid button has been pressed.” are not displayed.

On-screen Display

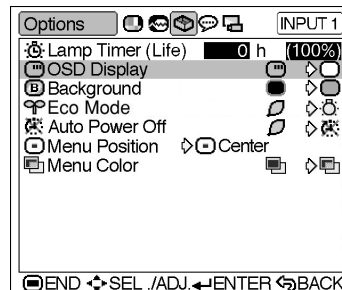



Using the “Options” Menu

Selecting the Signal Type

This function allows you to select the input signal type Component or RGB for INPUT 2.

Select “Signal Type” in the “Options” menu on the menu screen.

→For operating the menu screen, see pages 38 to 41.

Selected Item	Description
RGB	Set when RGB signals are received.
Component	Set when Component signals are received.

Note

- “RGB” or “Component” can be selected with on the remote control only in INPUT 2.

Setting the Video Signal (VIDEO menu only)

The video input system mode is preset to “Auto”; however, it can be changed to a specific system mode if the selected system mode is not compatible with the connected audiovisual equipment.

Select “Video System” in the “Options” menu on the menu screen.

→For operating the menu screen, see pages 38 to 41.

Note

- When the system mode is set to “Auto”, you may not receive a clear picture due to signal differences. Should this occur, switch to the video system of the source signal.
- “Auto” cannot be set for PAL-M and PAL-N input signals. Select “PAL-M” or “PAL-N” in “Video System” menu for PAL-M and PAL-N input signals.

On-screen Display

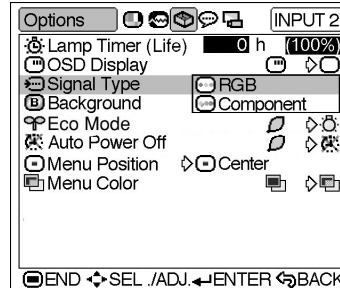

RGB/COMP. button

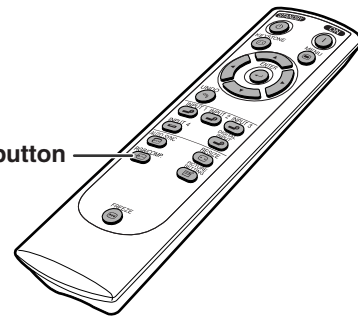

On-screen Display

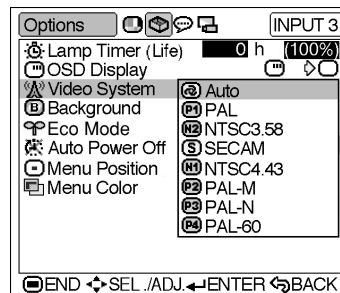



Selecting a Background Image

This function allows you to select the image displayed when no signal is being sent to the projector.

Select “Background” in the “Options” menu on the menu screen.

→For operating the menu screen, see pages 38 to 41.

Selected Item	Description
(Blue)	Blue screen
(None)	Black screen

Setting the Eco Mode

This function allows you to select the desired power consumption mode.

Select “Eco Mode” in the “Options” menu on the menu screen.

→For operating the menu screen, see pages 38 to 41.

Selected Item	Brightness	Power consumption	Lamp life
(Eco mode)	80%	230 W	Approx. 4,000 hours
(Standard mode)	100%	285 W	Approx. 3,000 hours

Note

- Although lamp life and noise are improved when “Eco Mode” is set to “” (Eco mode), brightness decreases by 20%.
- “Eco Mode” is factory preset to “” (Standard mode).

On-screen Display

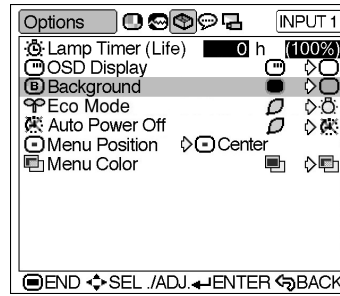

On-screen Display

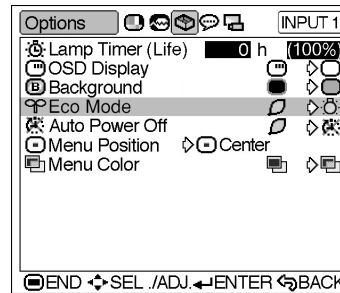



Using the “Options” Menu

Automatic Power Shut-off Function

When no input signal is detected for more than 15 minutes, the projector will automatically enter the standby mode if set to “” (ON).

Select “Auto Power Off” in the “Options” menu on the menu screen.

→For operating the menu screen, see pages 38 to 41.

Selected Item	Description
	Projector automatically enters the standby mode after 15 minutes without an input signal.
	Automatic Power Shut-off disabled.

Note

- “Auto Power Off” is factory preset to “”.
- When the Auto Power Off function is set to “ (ON)”, 5 minutes before the projector enters the standby mode, the message “Enter STANDBY mode in X min.” will appear on the screen to indicate the remaining minutes.

Selecting the Menu Screen Position

This function allows you to select the desired position of the menu screen.

Select “Menu Position” in the “Options” menu on the menu screen.

→For operating the menu screen, see pages 38 to 41.

Selected Item	Description
Center	The menu is displayed on the center of the image.
Upper Right	The menu is displayed on the upper right of the image.
Lower Right	The menu is displayed on the lower right of the image.
Upper Left	The menu is displayed on the upper left of the image.
Lower Left	The menu is displayed on the lower left of the image.

On-screen Display

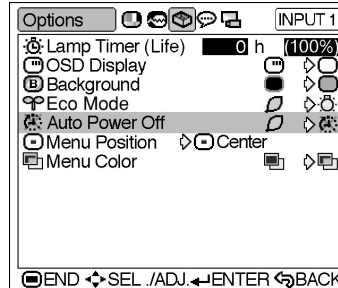

Enter STANDBY mode in 1 min.



On-screen Display

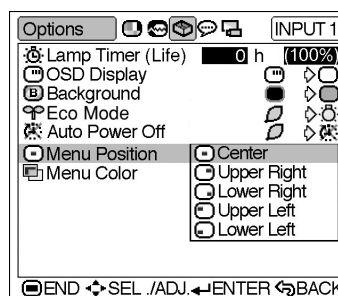





Selecting the Menu Color

This function allows you to select the color of the menu screen.

Select “Menu Color” in the “Options” menu on the menu screen.

→For operating the menu screen, see pages 38 to 41.

Selected Item	Description
 (Opaque)	The menu is displayed opaquely.
 (Translucent)	The menu is displayed translucently. The part of the menu on the image becomes transparent.

On-screen Display

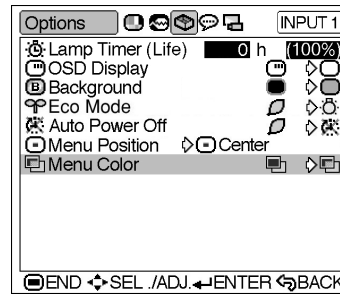



Reversing/Inverting Projected Images

This projector is equipped with a reverse/invert image function that allows you to reverse or invert the projected image for various applications.

Setting the Projection Mode

Display the “PRJ Mode” menu and select the desired projection mode.
→For operating the menu screen, see pages 38 to 41.

Selected Item	Description
Front	Normal image
Ceiling + Front	Inverted image
Rear	Reversed image
Ceiling + Rear	Reversed and inverted image

Note

- This function is used for the reversed image and ceiling-mount setups. See page 28 for these setups.

On-screen Display

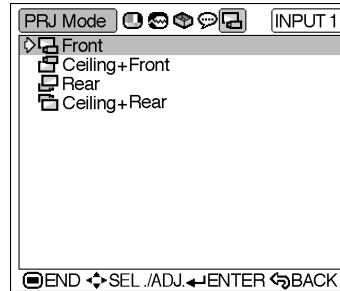



Appendix

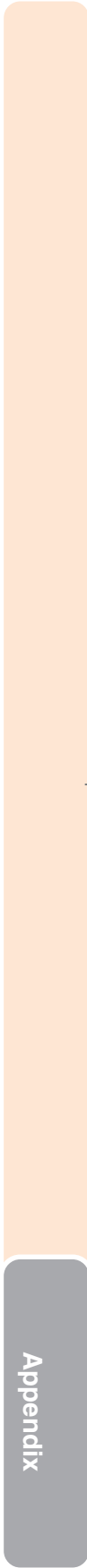
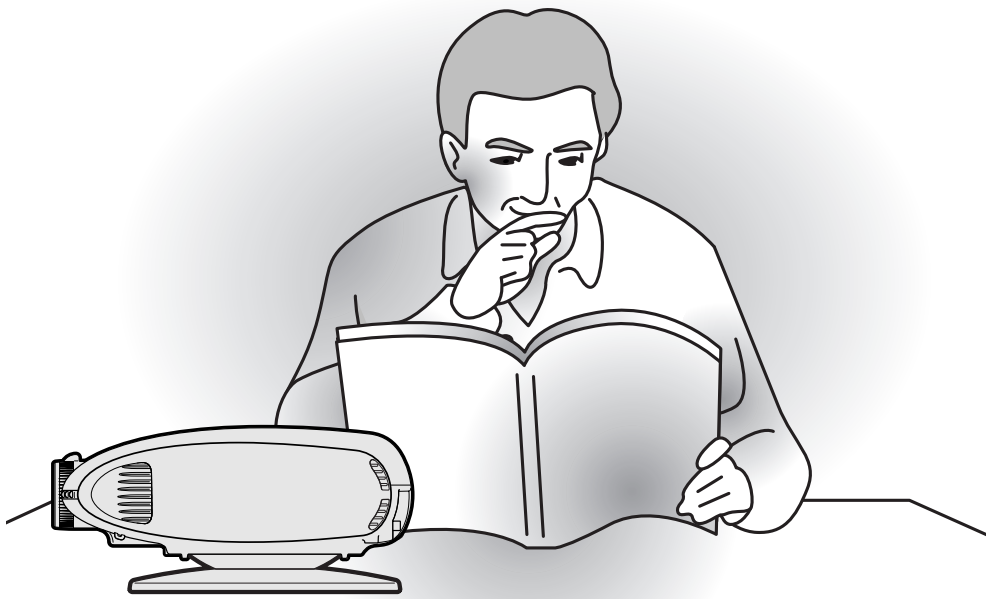

Appendix

Maintenance Indicators

- The warning lights on the projector indicate problems inside the projector.
- If a problem occurs, either the temperature warning indicator or the lamp indicator will illuminate red, and the projector will enter the standby mode. After the projector has entered the standby mode, follow the procedures given below.

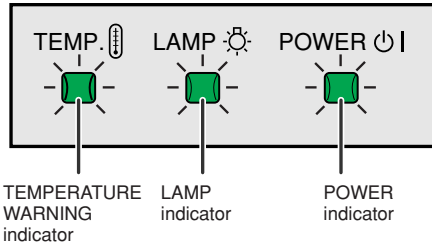

About the temperature warning indicator

If the temperature inside the projector increases, due to blockage of the air vents, or the setting location, "TEMP." will



illuminate in the lower left corner of the picture. If the temperature keeps on rising, the lamp will turn off and the temperature warning indicator will blink, the cooling fan will run for a further 90 seconds, and then the projector will enter the standby mode. After "TEMP." appears, be sure to perform the following measures.

About the lamp indicator



- The lamp life becomes 0%, when used for approximately 4,000 hours with "Eco mode" or when used for approximately 3,000 hours with "Standard mode" (see page 53).
- When the remaining lamp life becomes 5% or less, "X" (yellow) will be displayed on the screen. When the percentage becomes 0%, "X" will change to "X" (red), the lamp will automatically turn off and then the projector will automatically enter the standby mode. At this time, the lamp indicator will illuminate in red.
- If you try to turn on the projector a fourth time without replacing the lamp, the projector will not turn on.

	Maintenance indicator		Condition	Problem	Possible Solution
	Normal	Abnormal			
Temperature warning indicator	Off	Red on/ Standby	The internal temperature is abnormally high.	<ul style="list-style-type: none"> Blocked air intake Cooling fan break-down Internal circuit failure Clogged air intake 	<ul style="list-style-type: none"> Relocate the projector to an area with proper ventilation. Take the projector to your nearest Authorized SharpVision Service Center or Dealer for repair.
Lamp indicator	Green on (Green blinks when the lamp is warming up.)	Red on	Time to change the lamp.	<ul style="list-style-type: none"> Remaining lamp life becomes 5% or less. 	<ul style="list-style-type: none"> Carefully replace the lamp. (See page 59.) Take the projector to your nearest Authorized SharpVision Service Center or Dealer for repair. Please exercise care when replacing the lamp.
		Red on/ Standby	The lamp does not illuminate.	<ul style="list-style-type: none"> Burnt-out lamp Lamp circuit failure 	
Power indicator	Green on/ Red on	Off	The power is not turned on.	<ul style="list-style-type: none"> The lamp unit cover is open. 	<ul style="list-style-type: none"> Securely install the cover. If the power is not turned on even when the lamp unit cover is securely installed, contact your nearest Authorized SharpVision Service Center or Dealer for advice.



Info

- If the temperature warning indicator illuminates, and the projector enters the standby mode, follow the possible solutions on the previous page and then wait until the projector has cooled down completely before plugging in the power cord and turning the power back on. (At least 5 minutes.)
- If the power is turned off for a brief moment due to power outage or some other cause while using the projector, and the power supply recovers immediately after that, the lamp indicator will illuminate in red and the lamp may not be lit. In this case, unplug the power cord from the AC outlet, replace the power cord in the AC outlet and then turn the power on again.
- If you want to clean the air vents during projector operation, be sure to put the projector into the standby mode. After the cooling fan has stopped, clean the vents.
- The cooling fan keeps the internal temperatures of the projector constant and this function is controlled automatically. The sound of the cooling fan may change during operation because the fan speed may change and this is not a malfunction.
- Do not unplug the power cord after the projector has entered the standby mode and while the cooling fan is running. The cooling fan runs for about 90 seconds.

Regarding the Lamp

Lamp

- It is recommended that the lamp (sold separately) be replaced when the remaining lamp life becomes 5% or less, or when you notice a significant deterioration in the picture and color quality. The lamp life (percentage) can be checked with the on-screen display. See page 51.
- For lamp replacement, please consult your nearest Authorized SharpVision Service Center or Dealer.

IMPORTANT NOTE TO U.S. CUSTOMERS:

The lamp included with this projector is backed by a 90-day parts and labor limited warranty. All service of this projector under warranty, including lamp replacement, must be obtained through a Sharp Authorized Projector Dealer or Service Center. For the name of the nearest Authorized SharpVision Service Center or Dealer, please call toll-free: 1-888-GO-SHARP (1-888-467-4277). U.S.A. ONLY

Caution Concerning the Lamp

- This projector utilizes a pressurized mercury lamp. A loud sound may indicate lamp failure. Lamp failure can be attributed to numerous sources such as: excessive shock, improper cooling, surface scratches or deterioration of the lamp due to a lapse of usage time. The period of time up to failure largely varies depending on the individual lamp and/or the condition and the frequency of use. It is important to note that failure can often result in the bulb cracking.
- When the lamp replacement indicator and on-screen display icon are illuminated, it is recommended that the lamp be replaced with a new one immediately, even if the lamp appears to be operating normally.
- Should the lamp break, the glass particles may spread inside the lamp unit or gas contained in the lamp may be vented into the room from the exhaust vent. Because the gas in this lamp includes mercury, ventilate the room well if the lamp breaks and avoid all exposure to the released gas. In case of exposure to the gas, consult a doctor as soon as possible.
- Should the lamp break, there is also a possibility that glass particles may spread inside of the projector. In such a case, it is recommended you contact your nearest Authorized SharpVision Service Center or Dealer to remove the damaged lamp and assure safe operation.

Replacing the Lamp

Caution

- Do not remove the lamp unit immediately after operation of the projector. The lamp will be hot and touching it can lead to burn or injury.
- Wait at least one hour after the power cord is disconnected to allow the surface of the lamp unit to fully cool before removing the lamp unit.
- If the new lamp does not light after replacement, take your projector to the nearest Authorized SharpVision Service Center or Dealer for repair. Purchase a replacement lamp unit of type BQC-XVZ200++1 from your nearest Authorized SharpVision Service Center or Dealer. Then carefully change the lamp by following the instructions described in this section. If you wish, you may have the lamp replaced at your nearest Authorized SharpVision Service Center or Dealer.



Regarding the Lamp

Removing and Installing the Lamp Unit

⚠ Caution

- Be sure to remove the lamp unit by the handle. Do not touch the glass surface of the lamp unit or the inside of the projector.
- To avoid injury to yourself and damage to the lamp, carefully follow the steps below.
- Replace the lamp after turning off the power and unplugging the power cord.

1 Put the projector into the standby mode.

- Press  .
- Wait until the cooling fan stops.

2 Unplug the power cord.

- Unplug the power cord from the AC socket.
- Leave the lamp until it has fully cooled down (about 1 hour).

3 Remove the Swivel Stand. (See page 24.)

4 Remove the lamp unit cover.

- Loosen the user service screw that secures the lamp unit cover.
- Slide the lamp unit cover in the direction of the arrow.

5 Remove the lamp unit.

- Loosen the securing screws from the lamp unit. Hold the lamp unit by the handle and pull it in the direction of the arrow.

Lamp unit

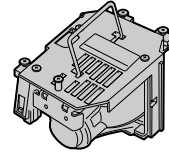

BQC-XVZ200++1

STANDBY button

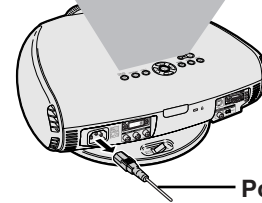
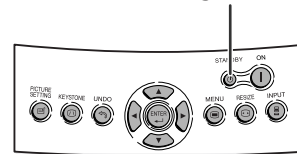

Power cord

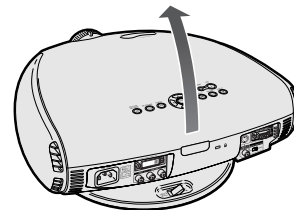

User service screw

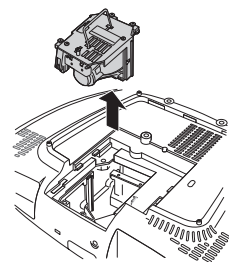
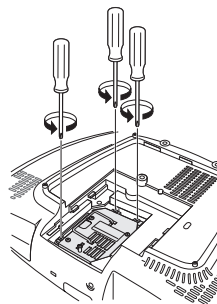
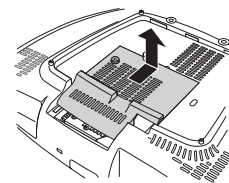
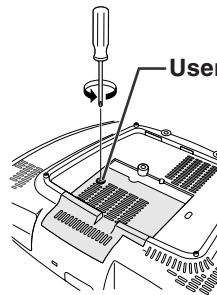



6 Insert the new lamp unit.

- Press the lamp unit firmly into the lamp unit compartment. Fasten the securing screws.

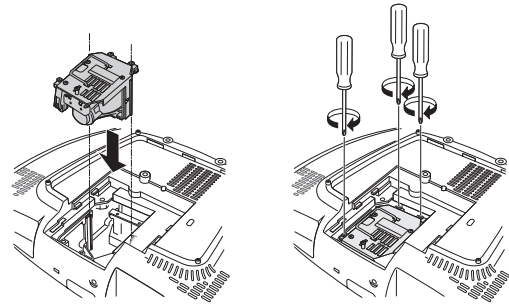

7 Attach the lamp unit cover.

- Slide the lamp unit cover in the direction of the arrow.
- Fasten the user service screw.

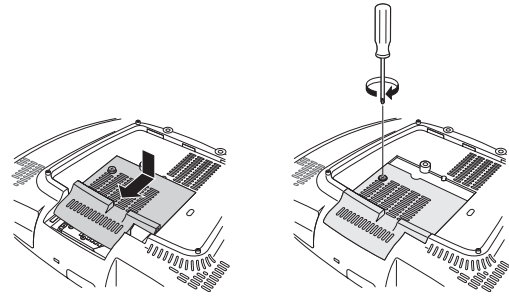

Resetting the Lamp Timer

Reset the lamp timer after replacing the lamp.

1 Plug the power cord.

- Confirm that the POWER indicator illuminates red.

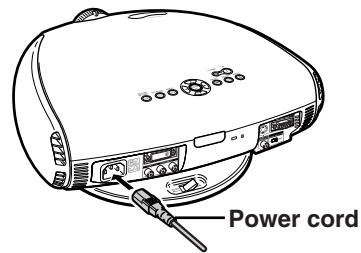

2 Reset the lamp timer.

- Press , , , , and in order. Then press .
- “LAMP 0000H” is displayed on the screen.

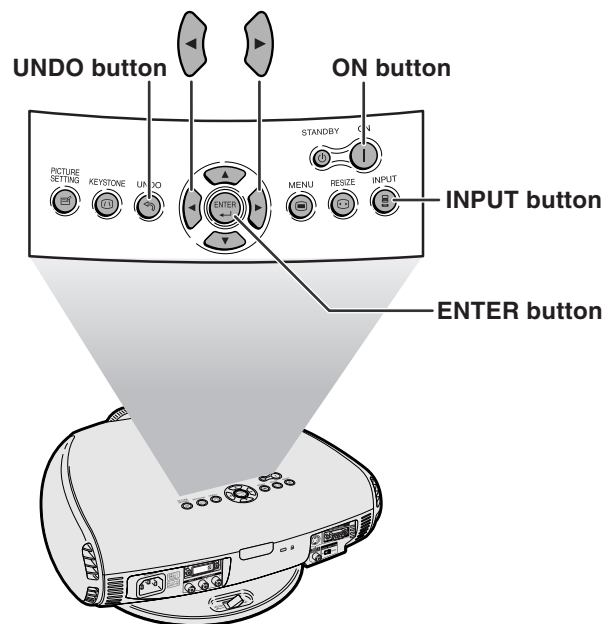

Info

- Make sure to reset the lamp timer only when replacing the lamp. If you reset the lamp timer and continue to use the same lamp, the lamp may become damaged or explode.



Cleaning the Ventilative Holes

- This projector is equipped with ventilative holes to ensure the optimal operating condition of the projector.
- Periodically clean the ventilative hole by vacuuming it off with a vacuum cleaner.
- The ventilative holes should be cleaned every 100 hours of use. Clean the ventilative holes more often when the projector is used in a dirty or smoky location.

Side and Rear view

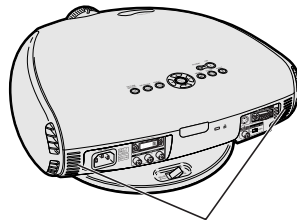

Intake ventilative holes

Bottom view

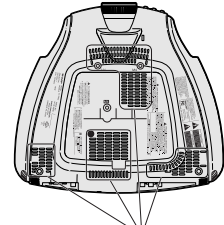

Intake ventilative holes

Swivel stand

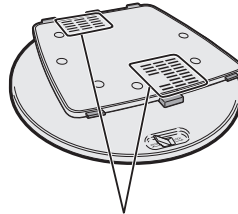

Intake ventilative holes

Cleaning the Ventilative Holes

1 Put the projector into the standby mode.

- Press  .
- Wait until the cooling fan stops.

2 Unplug the power cord.

3 Clean the dust off by putting the cleaner hose on the intake ventilative holes.

STANDBY button

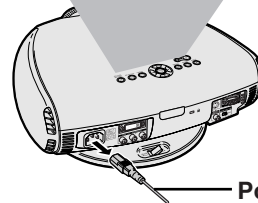
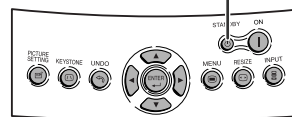

Power cord

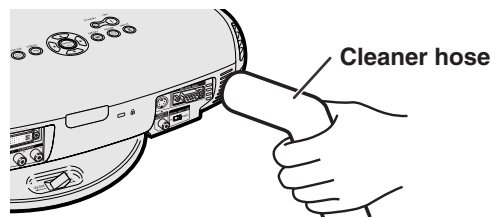

Cleaner hose



Using the Kensington Lock

This projector has a Kensington Security Standard connector for use with a Kensington MicroSaver Security System. Refer to the information that came with the system for instructions on how to use it to secure the projector.

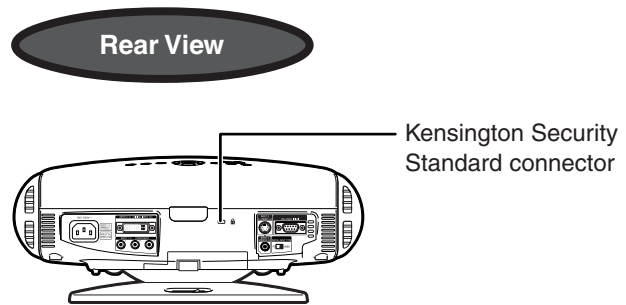

Troubleshooting

Problem	Check
No picture appears.	<ul style="list-style-type: none"> • Projector power cord is not plugged into the wall outlet. • Selected input is wrong. (See page 31.) • Cables incorrectly connected to back panel of the projector. (See pages 14-23.) • "Contrast" and "Bright" adjustments are set to minimum position. (See page 44.)
Color is faded or poor.	<ul style="list-style-type: none"> • Picture adjustments are not correct. (See page 44.)
Picture is blurred.	<ul style="list-style-type: none"> • Adjust the focus. (See page 25.) • Projection distance is too long or too short to allow for proper focus. (See pages 26 and 27.)
No OSD appears.	<ul style="list-style-type: none"> • OSD Display is set to "OFF", preventing to display some or all On-screen Displays. (See page 51.)
An unusual sound is occasionally heard from the cabinet.	<ul style="list-style-type: none"> • If the picture is normal, the sound is due to cabinet shrinkage caused by temperature changes. This will not affect operation or performance of the projector.
Maintenance indicator illuminates.	<ul style="list-style-type: none"> • Refer to "Maintenance Indicators" on page 58.
Picture noise appears.	<ul style="list-style-type: none"> • Adjust the "Phase" setting. (See page 48.)
Image is green on INPUT 2 Component. Image is pink (no green) on INPUT 2 RGB.	<ul style="list-style-type: none"> • Change the input signal type. (See page 52.)

For SHARP Assistance (U.S.A. only)

If you encounter any problems during setup or operation of this projector, first refer to the "Troubleshooting" section on this page. If this operation manual does not answer your question, please call toll free 1-877-DTV-SHARP (1-877-388-7427) for further assistance. Or, send us an e-mail at lcdsupport@sharpsec.com. Our World Wide Web address is <http://www.sharpusa.com/>.

Connecting Pin Assignments

DVI-I (INPUT 2 / DIGITAL INPUT) port : 29 pin connector

• DVI Digital INPUT

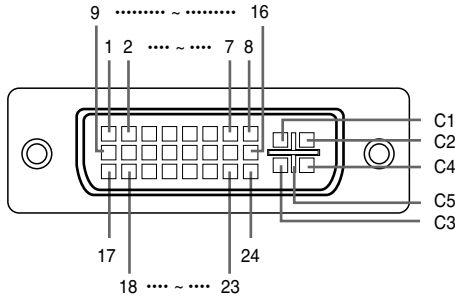

Pin No.	Signal	Pin No.	Signal
1	T.M.D.S data 2-	16	Hot plug detection
2	T.M.D.S data 2+	17	T.M.D.S data 0-
3	T.M.D.S data 2 shield	18	T.M.D.S data 0+
4	Not connected	19	T.M.D.S data 0 shield
5	Not connected	20	Not connected
6	DDC clock	21	Not connected
7	DDC data	22	T.M.D.S clock shield
8	Not connected	23	T.M.D.S clock+
9	T.M.D.S data 1-	24	T.M.D.S clock-
10	T.M.D.S data 1+	C1	Not connected
11	T.M.D.S data 1 shield	C2	Not connected
12	Not connected	C3	Not connected
13	Not connected	C4	Not connected
14	+5V power	C5	Ground
15	Ground		

• DVI Analog RGB Input

Pin No.	Signal	Pin No.	Signal
1	Not connected	16	Hot plug detection
2	Not connected	17	Not connected
3	Not connected	18	Not connected
4	Not connected	19	Not connected
5	Not connected	20	Not connected
6	DDC clock	21	Not connected
7	DDC data	22	Not connected
8	Vertical sync	23	Not connected
9	Not connected	24	Not connected
10	Not connected	C1	Analog input Red
11	Not connected	C2	Analog input Green
12	Not connected	C3	Analog input Blue
13	Not connected	C4	Horizontal sync
14	+5V power	C5	Ground
15	Ground		

• DVI Analog Component Input

Pin No.	Signal	Pin No.	Signal
1	Not connected	16	Not connected
2	Not connected	17	Not connected
3	Not connected	18	Not connected
4	Not connected	19	Not connected
5	Not connected	20	Not connected
6	Not connected	21	Not connected
7	Not connected	22	Not connected
8	Not connected	23	Not connected
9	Not connected	24	Not connected
10	Not connected	C1	Analog input Pr/Cr
11	Not connected	C2	Analog input Y
12	Not connected	C3	Analog input Pb/Cb
13	Not connected	C4	Not connected
14	Not connected	C5	Ground
15	Ground		

RS-232C Port: 9-pin D-sub male connector

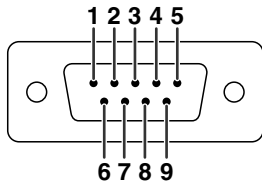

Pin No.	Signal	Name	I/O	Reference
1				Not connected
2	RD	Receive Data	Input	Connected to internal circuit
3	SD	Send Data	Output	Connected to internal circuit
4		Reserved		Connected to internal circuit
5	SG	Signal Ground		Connected to internal circuit
6		Reserved		Connected to internal circuit
7		Reserved		Connected to internal circuit
8		Reserved		Connected to internal circuit
9				Not connected

(RS-232C) Specifications and Command Settings

PC control

A computer can be used to control the projector by connecting an RS-232C cable (null modem, cross type, commercially available) to the projector. (See page 23 for connection.)

Communication conditions

Set the serial port settings of the computer to match that of the table.

Signal format: Conforms to RS-232C standard.

Baud rate: 9,600 bps

Data length: 8 bits

Parity bit: None

Stop bit: 1 bit

Flow control: None

Basic format

Commands from the computer are sent in the following order: command, parameter, and return code. After the projector processes the command from the computer, it sends a response code to the computer.

Command format

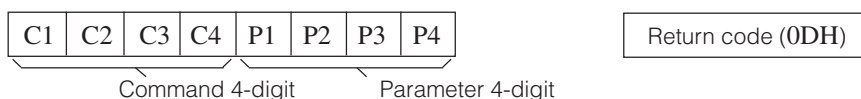

Response code format

Normal response



Problem response (communication error or incorrect command)



Info

- When more than one code is being sent, send each command only after the OK response code for the previous command from the projector is verified.

Note

- When using the computer control function of the projector, the projector's operating status cannot be read by the computer. Therefore, confirm the status by transmitting the display commands for each adjustment menu and checking the status with the on-screen display.

Commands

Example:

- When power on.

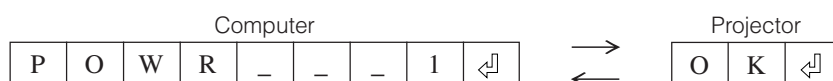

	CONTROL CONTENTS	COMMAND	PARAMETER	RETURN
BUTTONS & REMOTE CONTROL BUTTONS	POWER ON	P O W R	_ _	1 OK OR ERR
	STANDBY	P O W R	_ _	0 OK OR ERR
	INPUT 1 (COMPONENT 1)	I V E D	_ _	1 OK OR ERR
	INPUT 2 (COMPONENT 2)	I V E D	_ _	2 OK OR ERR
	INPUT 3 (S-VIDEO)	I V E D	_ _	3 OK OR ERR
	INPUT 4 (VIDEO)	I V E D	_ _	4 OK OR ERR
	DIGITAL INPUT MODE	I V E D	_ _	5 OK OR ERR

Note

- If an underbar (_) appears in the parameter column, enter a space.



Computer Compatibility Chart

Horizontal Frequency: 15–70 kHz
 Vertical Frequency: 43–75 Hz
 Pixel Clock: 12–80 MHz
 Compatible with sync on green
 XGA compatible in intelligent compression

PC/ MAC/ WS	Resolution	Horizontal Frequency (kHz)	Vertical Frequency (Hz)	VESA Standard	DVI Support	Display		
PC	640 × 350	27.0	60			Upscale		
		31.5	70					
	720 × 350	27.0	60					
		31.5	70					
	640 × 400	27.0	60					
		31.5	70					
	720 × 400	27.0	60					
		31.5	70					
	640 × 480	26.2	50		✓		✓	
		31.5	60	✓	✓		✓	
		34.7	70		✓		✓	
		37.9	72	✓	✓		✓	
	800 × 600	SVGA	37.5	75	✓		✓	Intelligent Compression
			31.4	50			✓	
			35.1	56	✓		✓	
			37.9	60	✓		✓	
			44.5	70			✓	
1,024 × 768	XGA	48.1	72	✓	✓			
		46.9	75	✓	✓			
		35.5	43	✓	✓			
		40.3	50		✓			
1,280 × 720	—	56.5	70	✓	✓			
		58.1	72		✓			
		45.0	60		✓			
PC/ MAC 13"	VGA	640 × 480	34.9	67			Upscale	
MAC 16"	SVGA	832 × 624	46.8	75			Intelligent Compression	
			49.6	75				
PC/ MAC 19"	XGA	1,024 × 768	48.4	60	✓			
			60.0	75	✓			

Note

- This projector may not be able to display images from notebook computers in simultaneous (CRT/LCD) mode. Should this occur, turn off the LCD display on the notebook computer and output the display data in “CRT only” mode. Details on how to change display modes can be found in your notebook computer’s operation manual.



Specifications

Product type	Projector
Model	XV-Z200U
Video system	PAL/PAL 60/PAL-M/PAL-N/SECAM/NTSC 3.58/NTSC 4.43 DTV 480I/480P/720P/1080I
Display method	DLP chip, RGB optical shutter method
DLP panel	Panel size: 0.6" Display method: Single Panel Digital Micromirror Device (DMD™) by Texas Instruments Drive method: Digital Light Processing (DLP™) No. of dots: 589,824 dots (1,024 [H] × 576 [V])
Lens	1–1.2 × zoom lens, F1.75–2.04 f=28.0–33.5 mm
Projection lamp	210 W/168 W SHP lamp
Video input signal	RCA Connector: VIDEO (INPUT 4), composite video, 1.0 Vp-p, sync negative, 75 Ω terminated
S-video input signal	4-pin Mini DIN connector (INPUT 3) Y (luminance signal): 1.0 Vp-p, sync negative, 75 Ω terminated C (chrominance signal): Burst 0.286 Vp-p, 75 Ω terminated
Component input signal (INPUT 1)	RCA Connector Y: 1.0 Vp-p, sync negative, 75 Ω terminated P _B : 0.7 Vp-p, 75 Ω terminated P _R : 0.7 Vp-p, 75 Ω terminated
Component input signal (INPUT 2)	29-pin connector DVI input signal: Digital 250–1,000 mV 50 Ω Analog 0.7 Vp-p 75 Ω Y: 1.0 Vp-p, sync negative, 75 Ω terminated P _B : 0.7 Vp-p, 75 Ω terminated P _R : 0.7 Vp-p, 75 Ω terminated
Horizontal resolution	520 TV lines (NTSC 3.58 input)
RGB input signal	DVI-I terminal <Digital> Input impedance 50 Ω Input level 250-1000 mV <Analog> Input impedance 75 Ω Input level 0.7 Vp-p <Synchronization signal> • Separate sync/Composite sync Input level TTL level Input impedance 1 KΩ • Green on sync Input level (Synchronizing input) 0.286 Vp-p Input impedance 75 Ω
Pixel clock	12–80 MHz
Vertical frequency	43–75 Hz
Horizontal frequency	15–70 kHz
Computer control signal	9-pin D-sub connector (RS-232C Port)
Rated voltage	AC 100–240 V
Input current	3.2 A
Rated frequency	50/60 Hz
Power consumption	285 W
Heat dissipation	1,070 BTU/hour
Operating temperature	41°F to 95°F (+5°C to +35°C)
Storage temperature	–4°F to 140°F (–20°C to +60°C)
Cabinet	Plastic
I/R carrier frequency	38 kHz
Dimensions (approx.)	14½" (W) × 6⅞" (H) × 12⅞" (D) (368 × 153.8 × 327 mm) (including swivel stand) 14½" (W) × 4⅞" (H) × 12⅞" (D) (368 × 118 × 327 mm) (main body only)
Weight (approx.)	10.1 lbs. (4.6 kg) (including swivel stand) 9.0 lbs. (4.1 kg) (main body only)
Supplied accessories	Remote control, Two AA size batteries, Power cord, Terminal cover, Lens cap (attached on the body), Operation manual, Screws for terminal cover
Replacement parts	Lamp unit (Lamp/cage module) (BQC-XVZ200++1), Remote control (RRMCGA218WJSA), AA size batteries, Power cord (QACCDAA007WJPZ), Terminal cover (GCOVAA116WJKB), Lens cap (CCAPHA004WJ01), Operation manual (TINS-B005WJZZ), Screws for terminal cover (XBBSN40P10000)

This SHARP projector uses a DMD chip. This very sophisticated chip contains 589,824 pixels. As with any high technology electronic equipment such as large screen TVs, video systems and video cameras, there are certain acceptable tolerances that the equipment must conform to.

This unit has some inactive pixels within acceptable tolerances which may result in inactive dots on the picture screen. This will not affect the picture quality or the life expectancy of the unit. If you have any questions about this matter, please call toll free 1-877-DTV-SHARP (1-877-388-7427). U.S.A. ONLY

Specifications are subject to change without notice.

E-67



Dimensions

Units: inches (mm)

Rear View

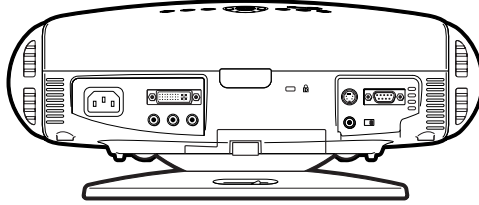

Side View

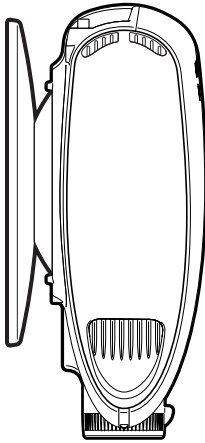

Top View



Side View

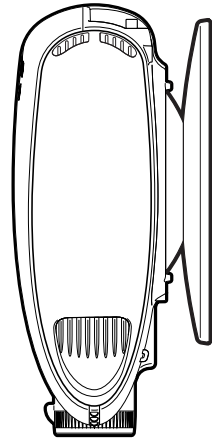

12 ⁷/₈ (327)

Front View

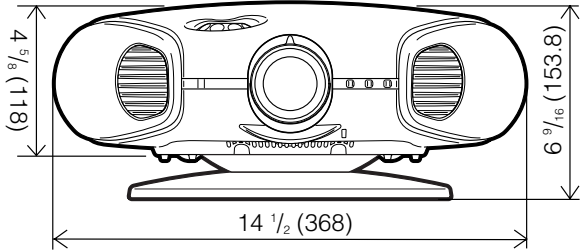

Bottom View

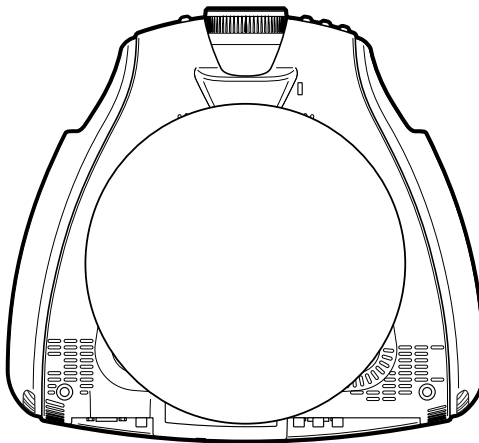



Glossary

Aspect Ratio

Width and height ratio of an image. The normal aspect ratio of a computer and video image is 4:3. There are also wide images with an aspect ratio of 16:9 and 21:9.

Auto Sync

Optimizes projected computer images by automatically adjusting certain characteristics.

Background

Initial setting image projected when no signal is being output.

Clock

Clock adjustment is used to adjust vertical noise when clock level is incorrect.

CLR Temp (Color temperature)

Function that can be used to adjust the color temperature to suit the type of image input to the projector. Decrease the color temperature to create warmer, reddish images for natural flesh tones, or increase to create cooler, bluish images for a brighter picture.

Composite sync

Signal combining horizontal and vertical sync pulses.

Digital keystone correction

Function to digitally correct a distorted image when the projector is set up at an angle, smoothes out jaggies on keystone images and compresses the image not only horizontally but vertically keeping the 16 : 9 aspect ratio.

DVI (Digital Visual Interface)

Display digital interface that also supports analog interfaces.

Gamma

Image quality enhancement function that offers a richer image by brightening the darker portions of the image without altering the brightness of the brighter portions. You can select from four different modes: Standard, Cinema 1, Cinema 2 and Cinema 3.

Intelligent compression and expansion

High quality resizing of lower and higher resolution images to fit the projector's native resolution.

Phase

Phase shift is a timing shift between isomorphic signals with the same resolution. When phase level is incorrect, the projected image typically displays horizontal flicker.

Resize

Allows you to modify or customize the picture display mode to enhance the input image. You can select from four different modes: SIDE BAR, SMART STRETCH, CINEMA ZOOM and STRETCH.

RS-232C

Function to control the projector from the computer by using the RS-232C ports on the projector and computer.

Stretch

Mode that stretches the 4:3 image horizontally to display it on the wide screen.

Sync on green

Video signal mode of a computer which overlaps horizontal and vertical sync signal to green color signal pin.



Index

A	
AC socket	14
Adjusting the Picture	44
ADJUSTMENT buttons	39
Aspect ratio	35
Automatic power shut-off function	54
Auto sync adjustment	50
AUTO SYNC button	50
B	
Background	53
C	
Ceiling-mount	28
Ceiling+Rear	56
Clock	48
COMPONENT terminals	17
D	
DIGITAL INPUT terminal	20
DVI	20
E	
Eco mode	53
ENTER button	39
Exhaust ventilative hole	6
F	
Focus ring	25
FREEZE button	35
I	
INPUT buttons	31
K	
Kensington Lock	63
KEYSTONE button	33
L	
LAMP indicator	58
Lens shift	25
M	
MENU button	38
O	
ON button	30
On-screen display	51
On-screen display language	31
P	
Phase	48
Power cord	14
POWER indicator	30
R	
Rear projection	28
Remote control	10
Remote control sensor	11
Remote control signal transmitter	10
RESIZE button	35
RS-232C terminal	23
S	
STANDBY button	32
STRETCH	35
S-VIDEO INPUT terminal	15
Sync on green	66
T	
TEMPERATURE WARNING indicator	58
U	
UNDO button	39
V	
VIDEO INPUT terminal	16
Video System	52
Z	
Zoom knob	25



VALID IN USA ONLY

CONSUMER LIMITED WARRANTY

SHARP ELECTRONICS CORPORATION warrants to the first consumer purchaser that this Sharp brand product (the "Product"), when shipped in its original container, will be free from defective workmanship and materials, and agrees that it will, at its option, either repair the defect or replace the defective Product or part thereof with a new or remanufactured equivalent at no charge to the purchaser for parts or labor for the period(s) set forth below.

This warranty does not apply to any appearance items of the Product nor to the additional excluded item(s) set forth below nor to any Product the exterior of which has been damaged or defaced, which has been subjected to improper voltage or other misuse, abnormal service or handling, or which has been altered or modified in design or construction.

In order to enforce the rights under this limited warranty, the purchaser should follow the steps set forth below and provide proof of purchase to the servicer.

The limited warranty described herein is in addition to whatever implied warranties may be granted to purchasers by law. ALL IMPLIED WARRANTIES INCLUDING THE WARRANTIES OF MERCHANTABILITY AND FITNESS FOR USE ARE LIMITED TO THE PERIOD(S) FROM THE DATE OF PURCHASE SET FORTH BELOW. Some states do not allow limitations on how long an implied warranty lasts, so the above limitation may not apply to you.

Neither the sales personnel of the seller nor any other person is authorized to make any warranties other than those described herein, or to extend the duration of any warranties beyond the time period described herein on behalf of Sharp.

The warranties described herein shall be the sole and exclusive warranties granted by Sharp and shall be the sole and exclusive remedy available to the purchaser. Correction of defects, in the manner and for the period of time described herein, shall constitute complete fulfillment of all liabilities and responsibilities of Sharp to the purchaser with respect to the Product, and shall constitute full satisfaction of all claims, whether based on contract, negligence, strict liability or otherwise. In no event shall Sharp be liable, or in any way responsible, for any damages or defects in the Product which were caused by repairs or attempted repairs performed by anyone other than an authorized servicer. Nor shall Sharp be liable or in any way responsible for any incidental or consequential economic or property damage. Some states do not allow the exclusion of incidental or consequential damages, so the above exclusion may not apply to you.

THIS WARRANTY GIVES YOU SPECIFIC LEGAL RIGHTS. YOU MAY ALSO HAVE OTHER RIGHTS WHICH VARY FROM STATE TO STATE.

Model Specific Section (In-Home Service)	XV-Z200U Projector
<u>Your Product Model Number & Description:</u>	(Be sure to have this information available when you need service for your Product.)
<u>Warranty Period for this Product:</u>	One (1) year parts and labor from date of purchase except for the Projector Lamp for which the warranty period is ninety (90) days from date of purchase. After the ninety (90) day warranty period on the Projector Lamp, parts and labor for a lamp replacement are the responsibility of the consumer.
<u>Additional Item(s) Excluded from Warranty Coverage (if any):</u>	Cleaning of Optical System and/or replacement of any filter. Labor & materials required to remove and reinstall a suspended projector in installations not accessible with a standard (8' step) ladder or ceilings exceeding 12' in height.
<u>Where to Obtain Service:</u>	Labor & materials required to remove and reinstall a projector in complex systems including, but not limited to, projectors installed in custom enclosures, projectors connected to third party control and automation systems, and realignment of projectors installed in "mirrored" rear projection enclosures.
<u>What to do to Obtain Service:</u>	From a Sharp Authorized Servicer located in the United States. To find the location of the nearest Sharp Authorized Servicer, call Sharp toll free at 1-800-BE-SHARP. Contact your Sharp Authorized Servicer to obtain in-home service for this Product. The Servicer will come to your home and if necessary to remove the Product for repair at the Servicer's facility, the Servicer will reinstall it upon completion of repair. Be sure to have Proof of Purchase available.

TO OBTAIN PRODUCT INFORMATION, CALL 1-877-DTV-SHARP OR VISIT www.sharppusa.com.



VALID IN CANADA ONLY

SHARP[®] LIMITED WARRANTY

Consumer Electronics Products Congratulations on your purchase!

Sharp Electronics of Canada Ltd. (hereinafter called "Sharp") gives the following express warranty to the first consumer purchaser for this Sharp brand product, when shipped in its original container and sold or distributed in Canada by Sharp or by an Authorized Sharp Dealer:

Sharp warrants that this product is free, under normal use and maintenance, from any defects in material and workmanship. If any such defects should be found in this product within the applicable warranty period, Sharp shall, at its option, repair or replace the product as specified herein.

This warranty shall not apply to:

- (a) Any defects caused or repairs required as a result of abusive operation, negligence, accident, improper installation or inappropriate use as outlined in the owner's manual.
- (b) Any Sharp product tampered with, modified, adjusted or repaired by any party other than Sharp, Sharp's Authorized Service Centres or Sharp's Authorized Servicing Dealers.
- (c) Damage caused or repairs required as a result of the use with items not specified or approved by Sharp, including but not limited to head cleaning tapes and chemical cleaning agents.
- (d) Any replacement of accessories, glassware, consumable or peripheral items required through normal use of the product including but not limited to earphones, remote controls, AC adapters, batteries, temperature probe, stylus, trays, filters, belts, ribbons, cables and paper.
- (e) Any cosmetic damage to the surface or exterior that has been defaced or caused by normal wear and tear.
- (f) Any damage caused by external or environmental conditions, including but not limited to transmission line/power line voltage or liquid spillage.
- (g) Any product received without appropriate model, serial number and CSA/cUL markings.
- (h) Any products used for rental or commercial purposes.
- (i) Any installation, setup and/or programming charges.

Should this Sharp product fail to operate during the warranty period, warranty service may be obtained upon delivery of the Sharp product together with proof of purchase and a copy of this LIMITED WARRANTY statement to an Authorized Sharp Service Centre or an Authorized Sharp Servicing Dealer. In home warranty service may be provided at Sharp's discretion on any Sharp television with the screen size of 27" or larger and on any Sharp Over The Range Microwave Oven.

This warranty constitutes the entire express warranty granted by Sharp and no other dealer, service centre or their agent or employee is authorized to extend, enlarge or transfer this warranty on behalf of Sharp. To the extent the law permits, Sharp disclaims any and all liability for direct or indirect damages or losses or for any incidental, special or consequential damages or loss of profits resulting from a defect in material or workmanship relating to the product, including damages for the loss of time or use of this Sharp product or the loss of information. The purchaser will be responsible for any removal, reinstallation, transportation and insurance costs incurred. Correction of defects, in the manner and period of time described herein, constitute complete fulfillment of all obligations and responsibilities of Sharp to the purchaser with respect to the product and shall constitute full satisfaction of all claims, whether based on contract, negligence, strict liability or otherwise.

WARRANTY PERIODS

Projector	1 year (bulb 90 days)
-----------	-----------------------

To obtain the name and address of the nearest Authorized Sharp Service Centre or Dealer, please contact:
SHARP ELECTRONICS OF CANADA LTD.

SHARP ELECTRONICS OF CANADA LTD.
335 Britannia Road East
Mississauga, Ontario
L4Z 1W9
(905) 568-7140
Web site: www.sharp.ca

